



For Android™ 13

Enterprise Mobility

PM352

User Manual

Instruction

This manual provides information about basic features and using the PM352. Please read this manual carefully before using your device and peripherals to ensure safe and proper use.



Note: Screenshots in this manual may differ from actual screens.

Revision History

Revision	Date	Description
v1.0	27 Jun 2024	Initial release
v1.1	02 Jul 2024	Removed unsupported feature icon

PM352 SKUs

The contents of this manual can cover the following SKUs.

SKU	Part Number	Scanner	Keypad	Network	Camera	Common
SKU1	P352E3T23DNE0T	SE965	Numeric	Wi-Fi 6E, Bluetooth	-	Android 13 GMS 4G/64G NFC
SKU2	P352E3223DNE0C	SE4100				
SKU3	P352E3W23DNE0C	SE4750SR-IM				
SKU4	P352E3263DNE0C	SE4100	Alpha-Numeric	LTE, Wi-Fi 6E, Bluetooth	Top Camera	
SKU5	P352E9W23DNE0C	SE4750SR-IM	Numeric			
SKU6	P352E9263DNE0C	SE4100	Alpha-Numeric			

Table of Contents

INSTRUCTION.....	1
Revision History	1
PM352 SKUs	1
GETTING STARTED.....	4
Device Parts.....	4
Product Standard Accessories.....	6
Install SD & SIM cards	7
Install & Remove Battery.....	10
Charge the Device	13
LED Indicator	17
Turn On / Off the Device	18
Use a Touch Screen	19
LEARNING THE BASICS	22
Setup Wizard	22
Home Screen	23
MTP Connection with PC	31
Manage the Files.....	32
Lock the Screen	33
Settings.....	34
USING THE KEYPAD.....	36
Keypad.....	36
Use the Buttons	44
CAMERA	47
SCANNER	48

Table of Contents

- Turn on / off the Scanner 48
- ScanSettings 49
- Scan a Barcode 58
- ScanDemo 59

- WIRELESS 60**
 - Mobile Network 60
 - Wi-Fi..... 61
 - Bluetooth..... 62
 - NFC..... 65

- SYSTEM MAINTENANCE 66**
 - System Information 66
 - Check Device Health..... 67
 - OS Update 68
 - Factory Data Reset 71

- ACCESSORIES 72**
 - Hand Strap..... 72
 - Gun Handle 74
 - Charging cradle..... 76

- SAFETY INFORMATION 79**
 - Battery Safety Information..... 79

Getting Started

Device Parts

Figure 1 PM352 front view

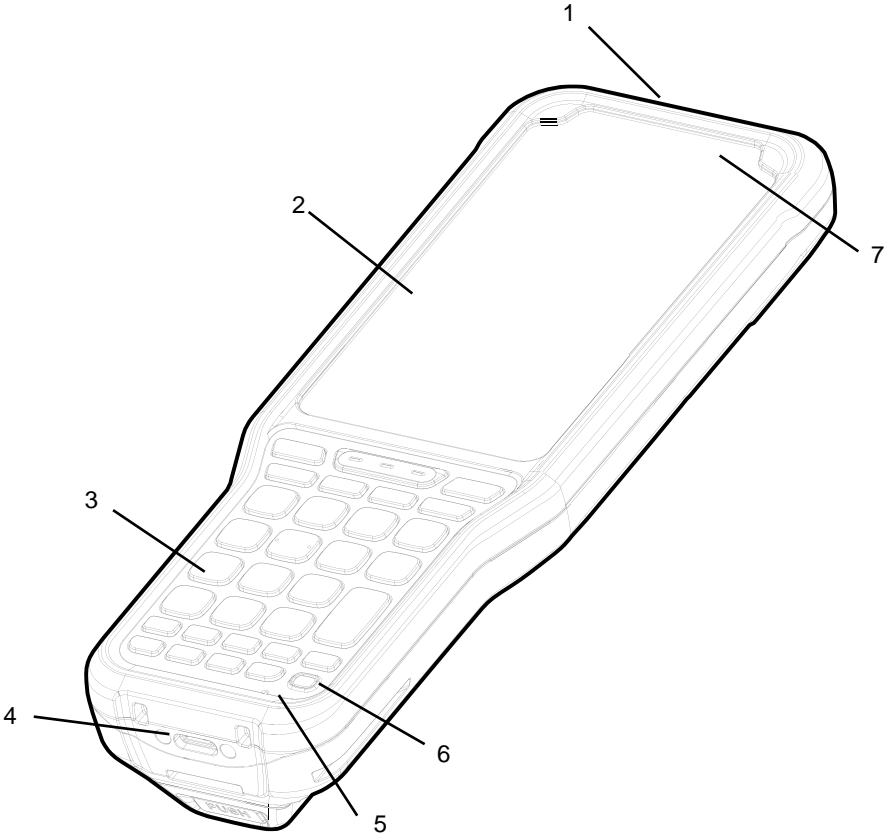

No	Name	Description
1	Scanner & Camera	Scans a barcode and take a picture
2	Touch screen	Displays all operating screen
3	Keypad	Numeric or Alpha numeric keypad (For more details, refer to Using the Keypad)
4	USB connector	USB Type C connector for charging and data communication
5	Microphone	Use for collecting sound
6	Power button	Turn on/off the device
7	LED indicator	Indicates the power status and notification. Find more details in LED indicator .

Getting Started

Figure 2 PM352 rear view

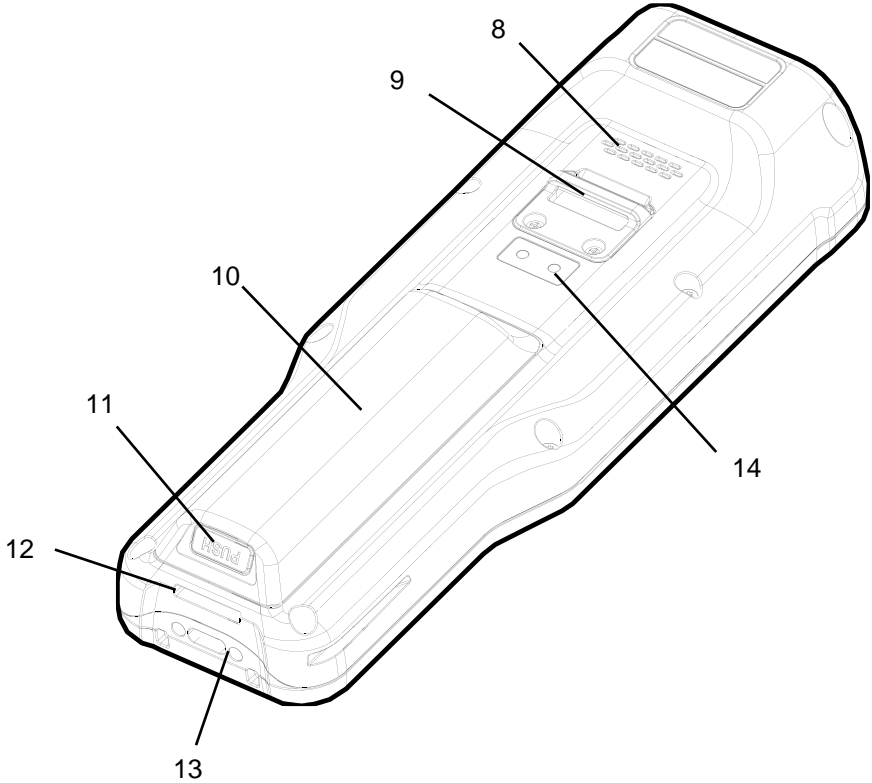





No	Name	Description
8	Speaker	Ring system sound
9	Hand strap hole (Top)	Mount a hand strap
10	Battery	Provide power
11	Battery release button	Press the button in to release the battery
12	Hand strap hole (Bottom)	Mount a hand strap
13	I/O connector (Bottom)	Connector for charging and communication with cradle
14	I/O connector (Rear)	Connector for sled type accessories (Gun handle)

Getting Started

Product Standard Accessories

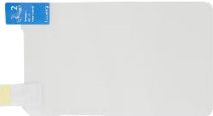
The following items are in the product box.

Accessory	Name
	Battery pack
	Charger
	AC plug
	LCD protection film
	Hand strap
	Stylus pen



Note: The images may differ from the actual accessory.

Getting Started

Install SD & SIM cards

PM352 supports

- MicroSD card
- Micro SIM card – WWAN (LTE) SKU only

You can find the card slots when removing the battery. Depending on SKU, the equipped card slots are different. Refer to the following table.

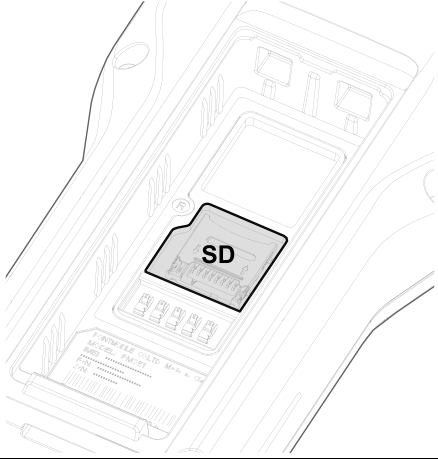
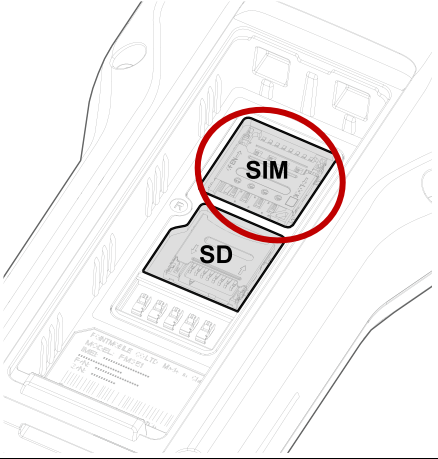
Wi-Fi SKU	WWAN (LTE) SKU
	

Getting Started

Install SD card

1. Remove the battery by pressing the battery release button.
2. Gently slide the cardholder down, and swing upwards to open the holder.

Figure 3 Open SD cardholder

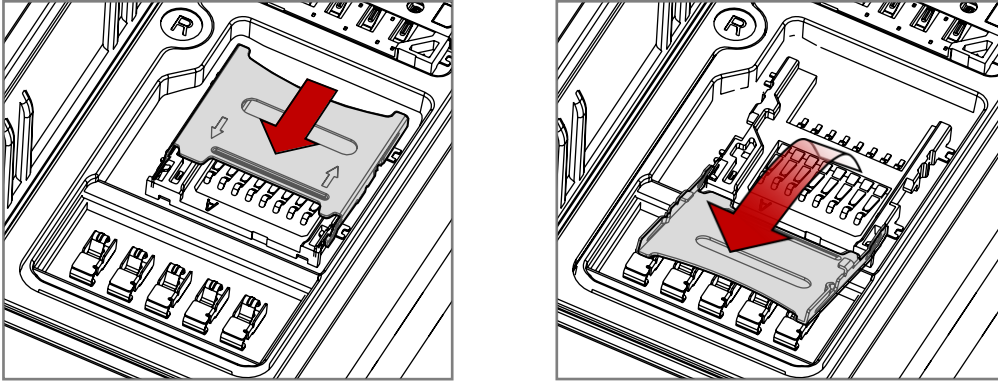

3. Put the SD card you prepared with the contacts facing down.

Figure 4 Place SD card

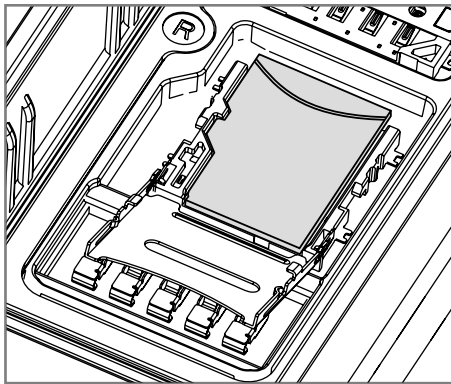

4. Close the holder down and gently slide it up to lock the holder.

Figure 5 Close SD cardholder

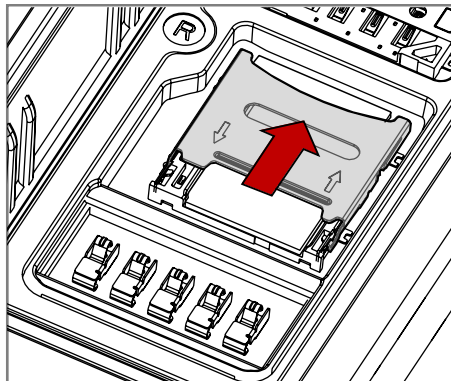

Getting Started

Install SIM card

1. Remove the battery while pressing the battery release button.
2. Gently slide the cardholder up, and swing upwards to open the holder.

Figure 6 Open SIM cardholder

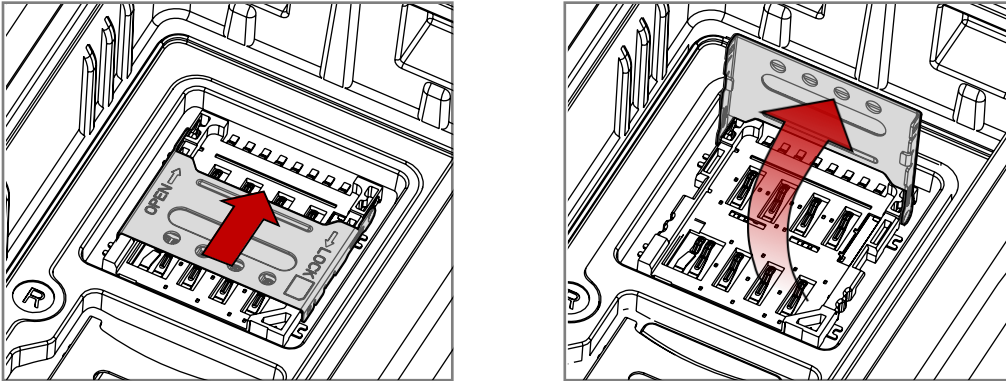

3. Put a micro SIM card you prepared with the contacts facing down.

Figure 7 Place SIM card

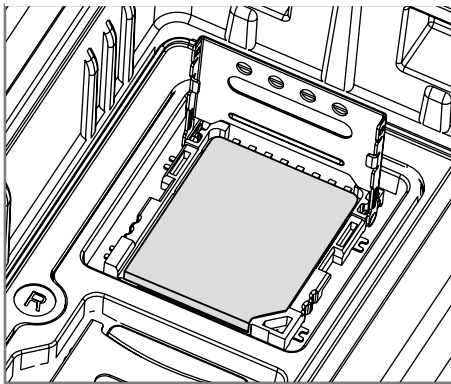

4. Close the holder down and gently slide it down to lock the holder.

Figure 8 Close SIM cardholder

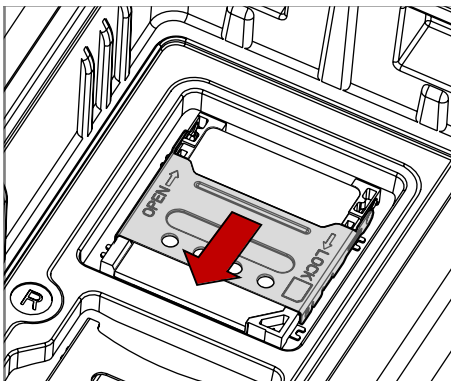

Getting Started

Install & Remove Battery

Install the battery



Caution: Make sure the cardholders are completely closed before installing the battery. It may damage the device if you force to install the battery while the cardholders are not closed.

1. Insert the battery from the top side (opposite side of the battery release button).

Figure 9 Insert battery

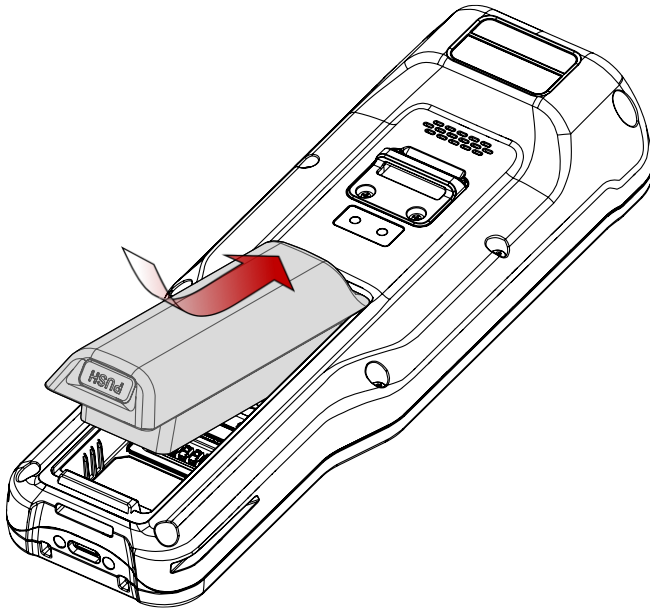

2. Push the battery down until it clicks.

Confirm that the battery release button are completely outward and the battery is firmly engaged.

Getting Started

Remove the battery

1. Press the battery release button.
2. While pressing the battery release button in, pull the battery up.

Figure 10 Remove battery

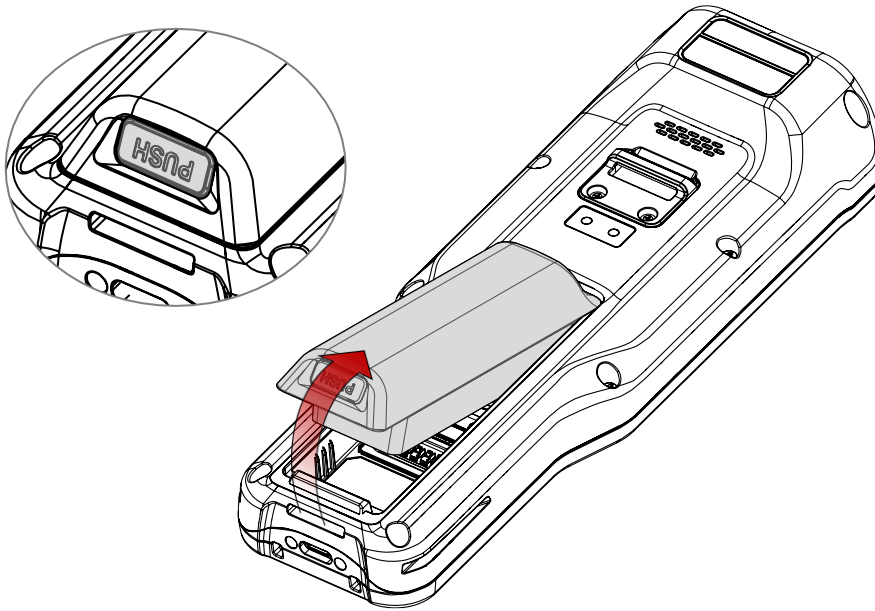

Getting Started

Battery hot swap

Battery hot swap is a feature that allows users to replace the battery without powering off.

PM352 supports two types of hot swap mode, Enterprise Hot Swap, and Legacy hot swap. Basically, the device enters Enterprise Hot Swap mode. You can change the preferred hot swap mode in EmSettings.

Enterprise Hot Swap

Enterprise hot swap allows the device to maintain Wi-Fi/Bluetooth connectivity and memory persistence even when detaching the battery. Users can earn time to replace the battery without stopping the ongoing task or disconnecting the Bluetooth devices.

But, as the backup battery with a smaller capacity than the main battery takes over to maintain the system, users are highly recommended to replace the battery within 30 seconds (30 seconds countdown displays). And some mitigations are activated to conserve power consumption.

- Reducing display brightness to about 10%
- Disabling NFC, Scanner
- Lowering sound volume

Once the user replaces the battery with a charged one, the device will come back to normal operation mode without booting process.



Notice: Do not change any settings or perform actions that may increase power consumption for device stability.

Legacy hot swap

When the battery is removed from the device, the display turns off, the device enters Hot swap mode and waits for battery replacement.

Once you replace the battery to a new one, the device will come back to normal operation mode without booting process.

Getting Started

Charge the Device

Before using PM352, charge the device enough to use. PM352 can be charged with power adapter or charging cradle. For best charging performance and safety, follow the normal [charging temperature](#).



Caution: Always use an original charger and cable from Point Mobile. Other chargers and cables may damage PM352. Also, make sure the charger and cables are not wet.

Follow the [Battery Safety Information](#) for safety of using the battery.

Battery specification

- Typical capacity: 4,800mAh / 3.6V
- Rechargeable & Removable battery

Charging temperature

Charge devices and batteries in temperatures from 0 °C to 45 °C. At out-of-normal range temperatures, the PM352 may stop charging for safety, and the power LED blinks red.

Getting Started

Smart Charging

PM352 supports three charging modes to provide optimal battery performance for your work.

- **Life-X mode (Default)**
 - An optimized charging mode that improves the battery's lifespan and stability.
- **Normal mode**
 - A typical charging mode.
- **Fast charging mode**
 - A charging mode that charges the battery faster than the other modes.

To change the smart charging mode, go to **Settings > Battery** or **EmKit > EmSettings**, and select **Smart Charging**.

Figure 11 Smart Charging

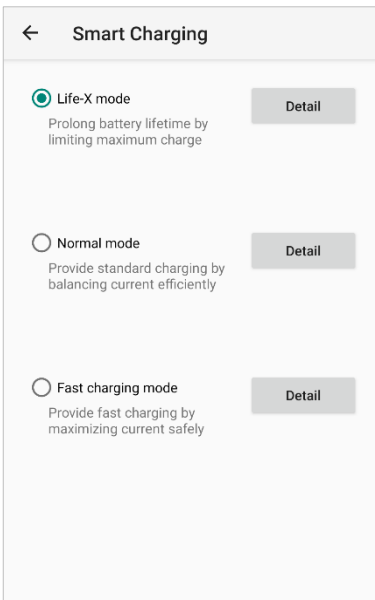

Getting Started

Charge with power adapter

1. Assemble a proper country plug and charger, and rotate the plug clockwise to engage firmly.
2. Connect the cable to the USB connector on the bottom side of PM352.
3. Provide power by plugging the charger to the wall socket.

Figure 12 Charge PM352 with power adapter

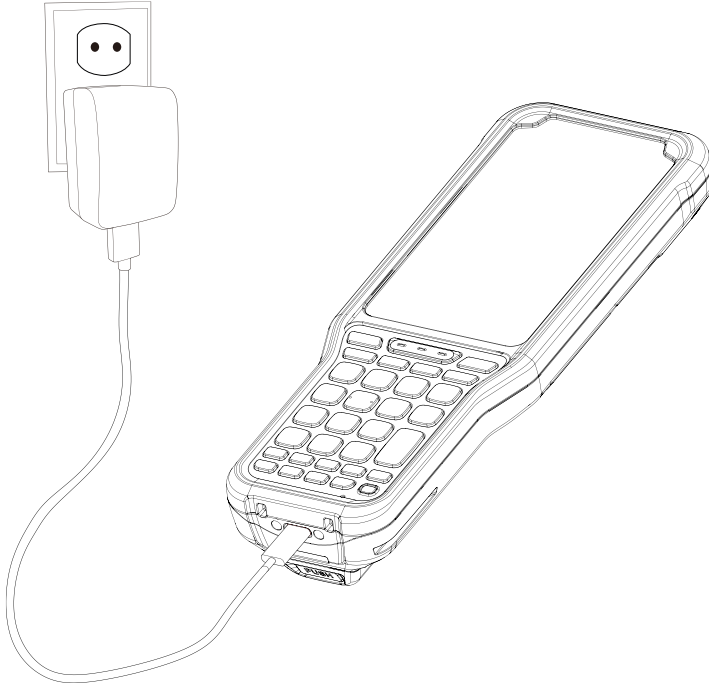

Getting Started

Charging Cradle

There are three types of charging cradle for PM352. Single slot cradle (SSC), 2 slot cradle (2SC), 4 slot battery cradle (4SBC). The cradles are sold separately and can be used in common with PM351.

Single Slot Cradle (SSC)

SSC provides one PM352 charging slot and one PM352 battery charging slot.

2 Slot Cradle (2SC)

2SC provides two PM352 charging slots.

4 Slot Battery Cradle (4SBC)

4SBC can charge up to 4 pieces of PM352 batteries at the same time.







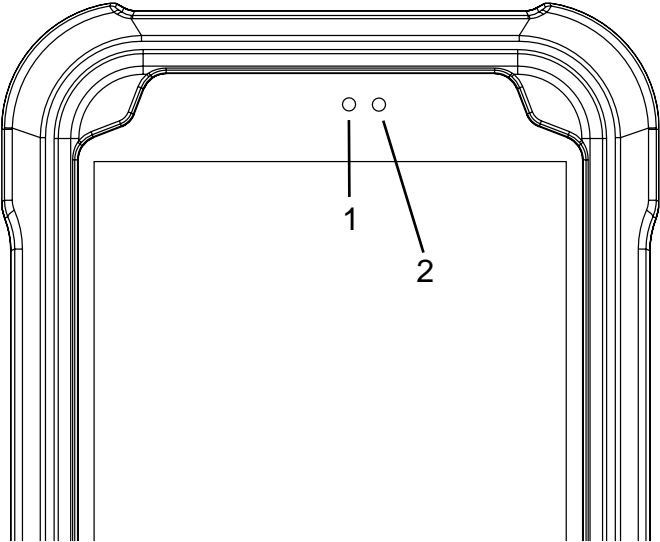

Getting Started

LED Indicator

PM352 has 2 LED indicators above the screen.

Figure 13 LED Indicators



No	Indicator	Status	Indication
1	Power LED	 Solid green	Device is completely charged
		 Solid red	Device is charging / Battery is low
		 Blinking red	Charging temperature is out-of-normal range (Refer to Charging temperature) / Battery is very low
		 Alternately blinking red & green	Cannot recognize the battery
2	Notification LED	 Solid red	Device entered Hot swap mode
		 Blinking blue	Notification existing
		 Red flash	Barcode reading failed
		 Blue flash	Barcode reading success

Getting Started

Turn On / Off the Device

To turn on the device,

- Press and hold the power button on the keypad until **SMART BEYOND RUGGED** logo displays on the screen.

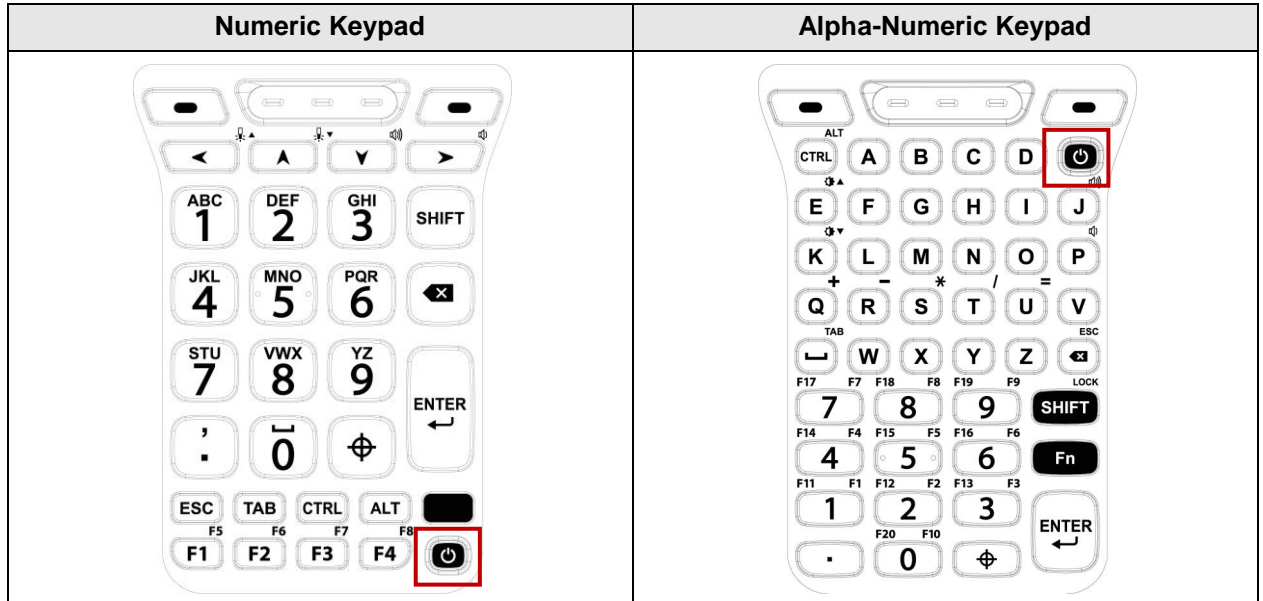

To turn off the device,

- Press and hold the power button until the power menu is shown when the display is on. Then, tap **Power off**.



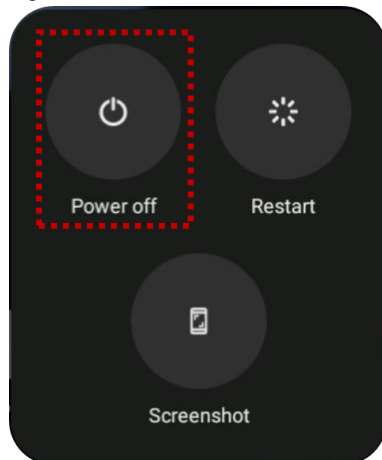
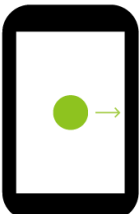
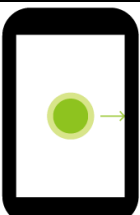
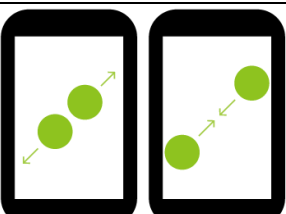

Figure 14 Power menu - Power off



Getting Started

Use a Touch Screen

Controlling the touch screen

Gesture	Description
	<p>Tap One-finger press</p>
	<p>Long-press One-finger press, wait, lift for select action</p>
	<p>Drag, Swipe, or Fling One-finger press, move, lift for scroll or tilt action</p>
	<p>Long-press drag One-finger press, wait, move, lift for pick up and move, or select multiple items action</p>
	<p>Pinch Open & Close Two-finger press, move outwards and inwards, lift for zoom in / out action</p>
	<p>Rotate When PM352 is turning sideways, screen orientation is changing</p>

Getting Started

System navigation

Navigation bar (Software button)

The navigation bar is enabled as a default, and it is located at the bottom of the screen. The app overview button, home button, and back button are placed on the bar in order.

Figure 15 Navigation bar



Shape	Button	Function
■	Recent apps button	Tap to see the recently used app list.
●	Home button	Tap to go to home screen. Long-press to launch the Google Assistant.
◀	Back button	Tap to go back to previous screen.

Getting Started

Gesture Navigation

If you are unfamiliar with the navigation bar or you want to see the screen with a wider screen, hide the navigation bar. The functions provided by the software buttons on the navigation bar can be used by using specific gestures.

To hide the navigation bar, navigate to **Setting**  > **System** > **Gesture** > **System navigation** and change the setting to **Gesture navigation**. Then, the navigation bar will be hidden.



Note: To use the navigation bar again, change the setting to **3-button navigation**.

Find the gestures and matched function in the table below.

Figure 16 Gesture navigation



Function	Gesture
Open recent apps screen	Swipe up from the bottom of the screen, hold, then release.
Go to home screen	Swipe up from the center-bottom of the screen.
Back to previous screen	Swipe from the left or right edge of the screen.
Launch Google Assistant	Swipe up from either the left-bottom or right-bottom.

Learning the Basics

Setup Wizard

When PM352 starts very first time or boot after factory reset, Setup Wizard is launched. Following the steps on the screen, set system language, Google account, Wi-Fi connection and copy the data, etc.

Some settings can be skipped, but there may be some restrictions on the use of the system.

Figure 18 Setup Wizard (main)

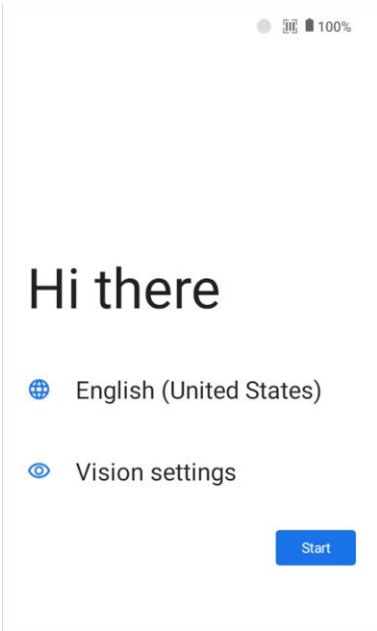
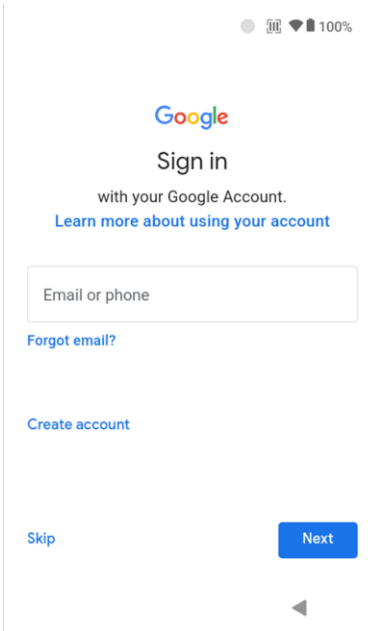

Figure 17 Setup Wizard (Google account)



Learning the Basics

Home Screen

Home screen is a screen displayed after Setup Wizard or pressing the Home button.

Figure 19 Home screen





























No	Item	Description
1	Status bar	Indicates device status and notification.
2	Google search	Search an item with Google
3	App	Tap to run the application Long-press to see the application's options
4	Favorites tray	Place the frequently used apps
5	App folder	Apps are organized in the folder. Tap to open the App folder

Learning the Basics

Status bar









Time, status icons, and notification icons are on the Status bar.

Status icons

Icon	Description	Icon	Description
LTE	LTE connected	3G	3G connected
	EDGE connected		
	Strong signal		Weak signal
	Connection issue		Data disabled
	No data connection		Connected to a Bluetooth device
	Connected to a Wi-Fi network		Data communication
	Airplane mode		Hotspot enabled
	Battery is full		Battery is low
	Battery is critical low		Cannot recognize battery
	Battery is charging		
	Vibrate mode		Alarm is set
	Scanner turned on		Scanner turned on, but trigger turned off
	Numeric input mode		Lowercase alphabet input mode
	Uppercase alphabet input mode (Temporary)		Uppercase alphabet input mode (Fixed)
	Functions input mode (Temporary)		Functions input mode (Fixed)
	CTRL functions mode		ALT functions mode

Learning the Basics

Notification icons

Icon	Description	Icon	Description
	New Email		Connected to VPN network
	Upcoming event		Other input method available
	File uploaded		File downloaded
	File copied		OTG device connected
	There are more notifications		

Notification panel

Notification panel displays a list of all notifications. Tap a notification to respond.

To open the Notification panel, drag the Status bar down. To close the panel, swipe it up.

Figure 20 Notification panel

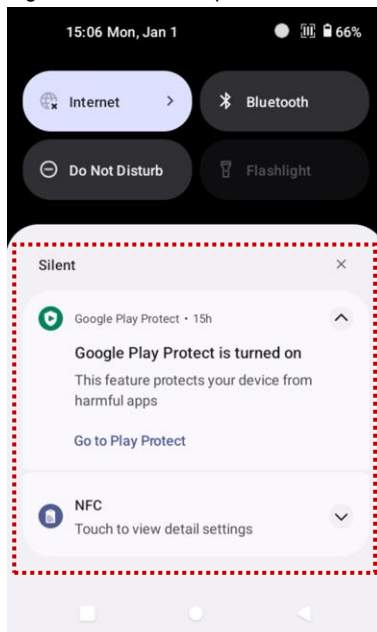

Learning the Basics

Quick setting panel

Quick setting panel contains some frequently used settings such as Wi-Fi, Bluetooth, etc.

To use the Quick setting panel,

1. Open the Notification panel.
2. Drag down the Notification panel.
3. Tap a setting icon to enable / disable the setting or long-press an icon to see more detail.

Figure 21 Quick setting panel

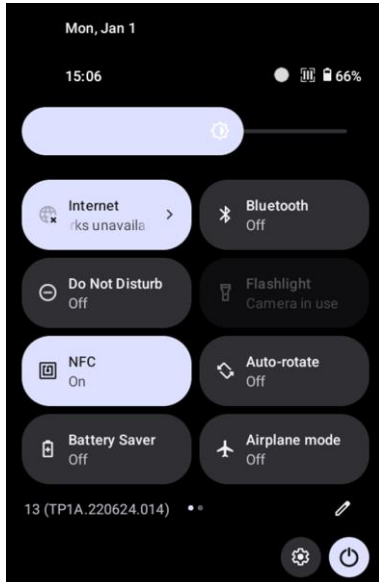

To edit the configuration of Quick setting panel,

1. Tap  on the bottom of the panel.
2. By long-press and dragging the icon, customize the configuration of the panel.

Learning the Basics

Apps & Widget

App folder

To create the app folder, long-press an app icon and drag it to another app icon.

Figure 22 Create app folder

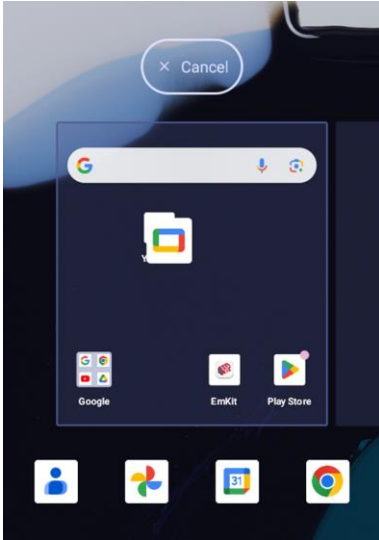

To change the folder name, tap the **Edit Name** and input a new name.

Figure 23 Change app folder name

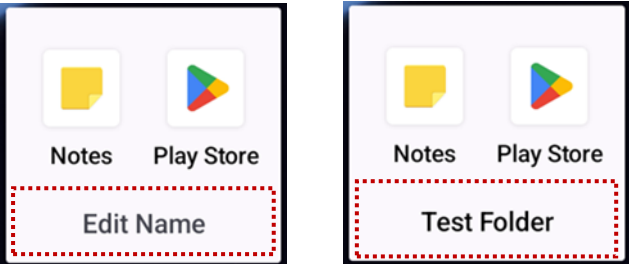

Learning the Basics

App drawer

All installed apps are listed alphabetically in App drawer.

- To open the App drawer, swipe up the Home screen.
- To close the App drawer, swipe down the screen.

Figure 24 App drawer

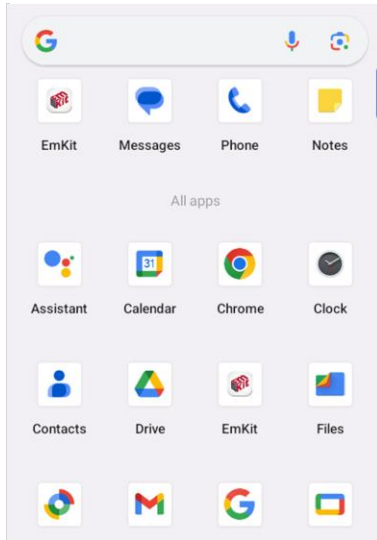

Favorites tray

To organize an app in the Favorites tray,

1. Long-press an app icon from the App drawer. Then, drag it slightly until the Home screen is shown.
2. Place the app icon in the Favorites tray.

Figure 25 Add an app to Favorites tray



Learning the Basics

Organize app in Home screen

To organize an app in the Home screen,

1. Long-press an app icon from the App drawer. Then, drag it slightly until the Home screen is shown.
2. Place the app icon where you want.

(To cancel to place the app, drag it to **Cancel** area and release.)

Figure 26 Place app in Home screen

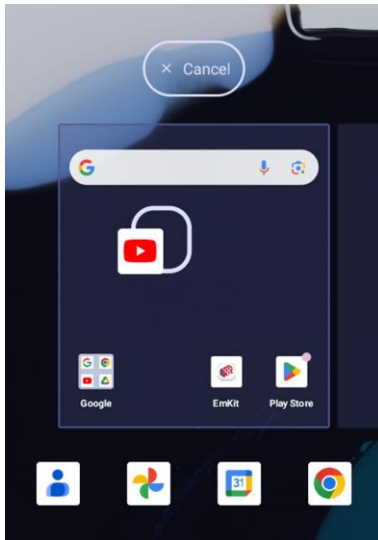

To remove an app or widget in the Home screen,

1. Long-press an app icon or widget.
2. Drag it to **Remove** area and release.

Figure 27 Remove from Home screen

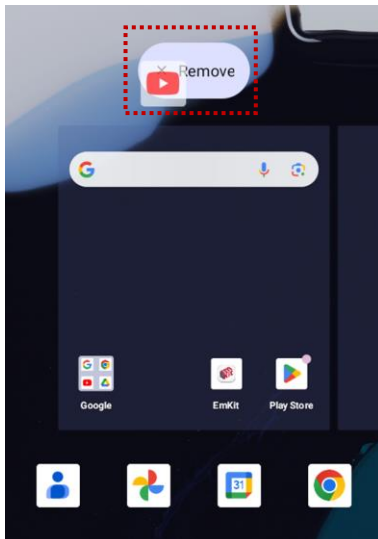

Learning the Basics

Widget

To add a widget in the Home screen,

1. Long-press the empty space of the Home screen.
2. In three menus, select **Widgets**.

Figure 28 Widget menu

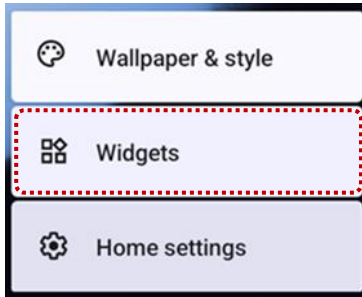

3. Among the list, tap and hold a widget you want to add.
4. Place the widget to the Home screen by dragging.

Learning the Basics

MTP Connection with PC

To transfer the files with a PC,

1. Connect the device to the PC via USB cable first.
2. Drag down Status bar and tap **Android System** notification to change USB preference option.

Figure 29 USB connection notification

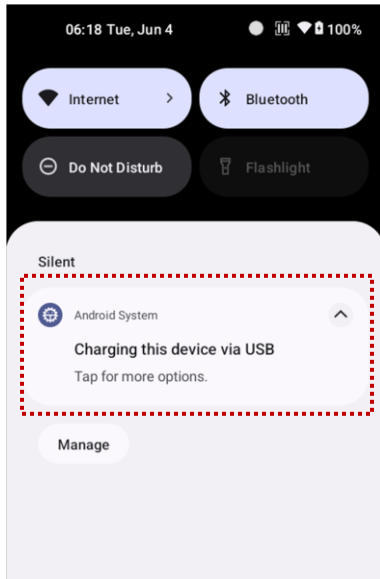

3. Change the option to **File Transfer** from **No data transfer**.

Figure 30 USB Preferences

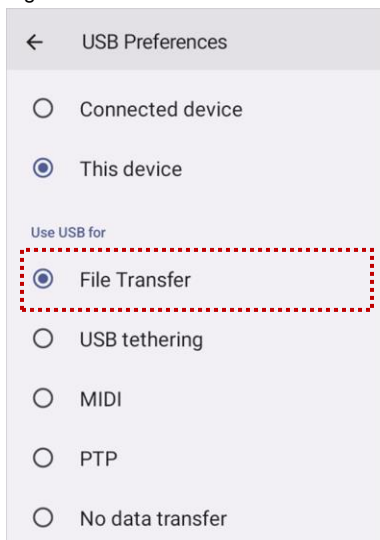

4. Now PC can recognize the connected device. Find PM352 device from file explorer of the PC.

Learning the Basics

Manage the Files

Launch **Files**  to manage the files in the storage.

You can find the folders and files, move / copy them to other location, and delete them from the storage.

Figure 31 Files

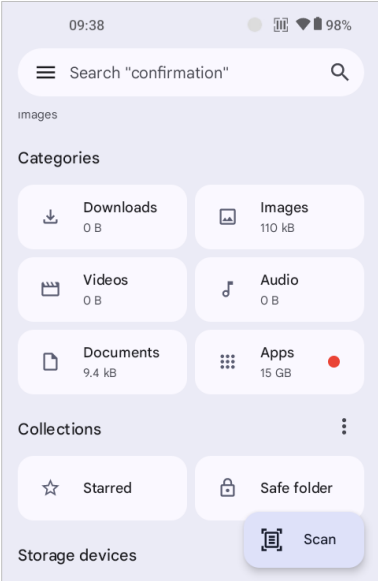

Learning the Basics

Lock the Screen

Protect the device from unauthorized personnel by setting up the screen lock.

1. Navigate to **Settings**  > **Security**.
2. Tap **Screen lock**.

Figure 32 Screen lock



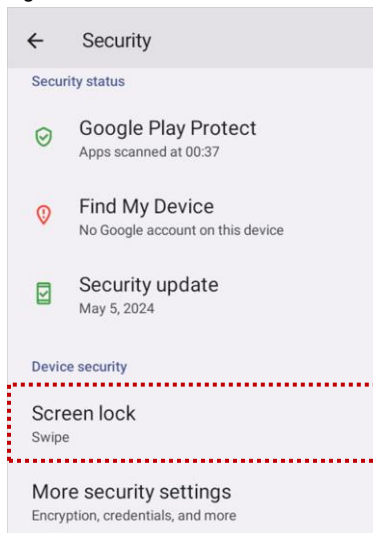

3. Choose a screen lock method.
 - None: Screen unlocks immediately
 - Swipe: Swipe the lock screen to unlock (Default)
 - Pattern: Draw a pattern to unlock
 - PIN: Input a PIN to unlock (At least 4 digits)
 - Password: Input a password to unlock (At least 4 characters)

Learning the Basics

Settings

There are two ways to go to **Settings**:

- Open the App drawer and tap **Settings** 
- Open the Quick setting panel and tap gear icon 

Adjust display brightness

To adjust the display brightness level,

- Open Quick setting panel and adjust display brightness bar
- Go to **Settings**  > **Display** > **Brightness level**

Figure 33 Normal brightness level



Figure 34 High brightness level (higher than 80%)



Caution: Using high brightness levels for long periods may cause eye strain and increase battery consumption.

Adjust sound

To adjust sound volume, go to **Settings**  > **Sound** and control the Media, Notification, Alarm volume bars.

Figure 35 Volume bars



Caution: Using high volume levels for long periods may cause ear strain and increase battery consumption.

Learning the Basics

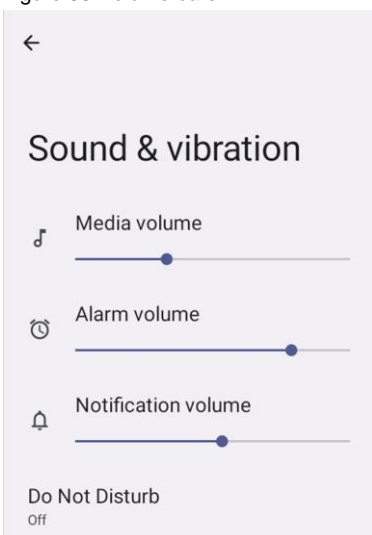
Adjust display and text size

If the display and text size of the screen is too small or too large, adjust the size.

1. Go to **Settings**  > **Display** > **Display size and text**.
2. Referring to the **Preview**, set the font size.

Figure 36 Set display and text size



Use Keyboard Backlight

The buttons in the keypad may not be visible in the dark. For this inconvenience, PM352 have keyboard backlight so that you can find the proper keys easily.

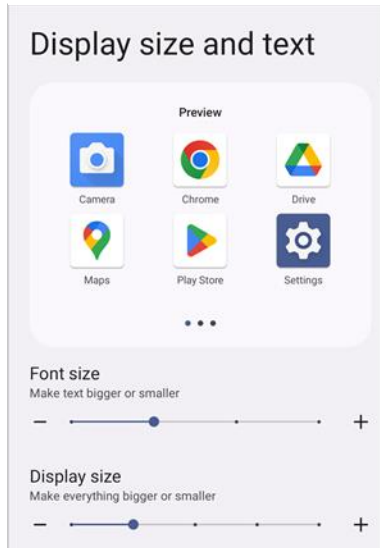
To use the keyboard backlight,

1. Go to **Settings**  > **Display**.
2. Tap **Keyboard Backlight** switch.

Figure 37 Keyboard Backlight



Using the Keypad

Keypad

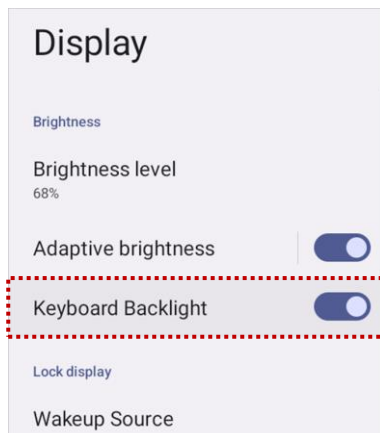

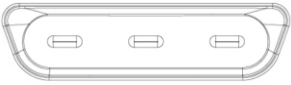

Numeric Keypad

Figure 38 PM352 Numeric keypad



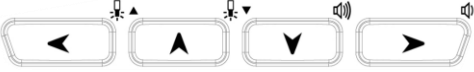









Key	Description
P1 / P2 SOFT_LEFT / SOFT_RIGHT 	Programmable keys, <ul style="list-style-type: none"> • P1 is the AppSwitch key by default. • P2 is the Back key by default.
Scan (Orange) SCANNER_F 	Scan the barcode







Using the Keypad

Key	Description									
<p>Left / Up / Down / Right DPAD_LEFT / UP / DOWN / RIGHT</p> 	<p>In Numeric input mode</p> <ul style="list-style-type: none"> Moves left / up / down / right. <p>In Alphabet input mode</p> <ul style="list-style-type: none"> Controls keypad backlight brightness and volume. Refer to Functions section for more detail. 									
<p>Numeric 0~9 0~9</p> 	<p>In Numeric input mode</p> <ul style="list-style-type: none"> Inputs 0 to 9. <p>In Alphabet input mode</p> <ul style="list-style-type: none"> Inputs alphabet in uppercase or lowercase, or blank space. 									
<p>Period / Decimal Point PERIOD</p> 	<p>In Numeric input mode</p> <ul style="list-style-type: none"> Inputs a period (decimal point) <p>In Alphabet input mode</p> <ul style="list-style-type: none"> Inputs decimal comma 									
<p>Symbol</p> 	<p>Press once</p> <ul style="list-style-type: none"> Inputs a symbol you set. By default, '~' will be inserted. <p>Press twice</p> <ul style="list-style-type: none"> Provides a 3x3 grid on the screen with nine additional symbols. Choose a symbol you want. <table border="1" data-bbox="846 1318 1117 1579"> <tbody> <tr> <td>✓ ~ \u007e</td> <td>@ \u0040</td> <td>- \u002d</td> </tr> <tr> <td>£ \u00a3</td> <td>: \u003a</td> <td>€ \u20ac</td> </tr> <tr> <td> \u007c</td> <td>[\u005b</td> <td>] \u005d</td> </tr> </tbody> </table> <ul style="list-style-type: none"> You can change the configuration of the grid with Program Buttons. Refer to Symbol grid. <p>Press three times</p> <ul style="list-style-type: none"> Hides the grid 	✓ ~ \u007e	@ \u0040	- \u002d	£ \u00a3	: \u003a	€ \u20ac	 \u007c	[\u005b] \u005d
✓ ~ \u007e	@ \u0040	- \u002d								
£ \u00a3	: \u003a	€ \u20ac								
 \u007c	[\u005b] \u005d								

Using the Keypad

Key	Description
<p>Shift</p> 	<p>Toggle key for shift combination input mode.</p> <p>Press once</p> <ul style="list-style-type: none">• Activates Shift combination input mode.• The  icon appears on status bar. ex)  <p>Press twice</p> <ul style="list-style-type: none">• Maintains the Shift combination input mode. The  icon appears on status bar. ex)  <p>Press three times</p> <ul style="list-style-type: none">• Back to default input mode.
<p>Backspace <i>BKSP</i></p> 	<p>Backspace function</p>
<p>Enter <i>ENTER</i></p> 	<p>Enter function</p>
<p>ESC <i>ESCAPE</i></p> 	<p>Escape function</p>
<p>TAB <i>TAB</i></p> 	<p>Tab function</p>
<p>CTRL (Control)</p> 	<p>Activates the CTRL functions mode.</p> <p>The  icon appears on the status bar.</p>

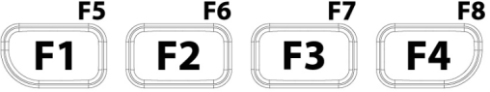
Using the Keypad



Key	Description
ALT 	Activates the ALT functions mode. The  icon appears on the status bar.
Alpha (Yellow) 	Toggle key for Alphabet input mode. The keycode or function shown on the keypad in yellow will be inputted in Alphabet input mode. Press once <ul style="list-style-type: none"> • Activates Alphabet input mode • The  icon appears on status bar Press twice <ul style="list-style-type: none"> • Back to default input mode
Function 1~4 (5~8) F1~F8 	In Numeric input mode <ul style="list-style-type: none"> • Executes the function mapped to F1 to F4 In Alphabet input mode <ul style="list-style-type: none"> • Executes the function mapped to F5 to F8
Power 	Turns on / off the device or screen

Using the Keypad

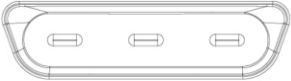

Alpha-Numeric Keypad

Figure 39 PM352 Alpha-Numeric keypad





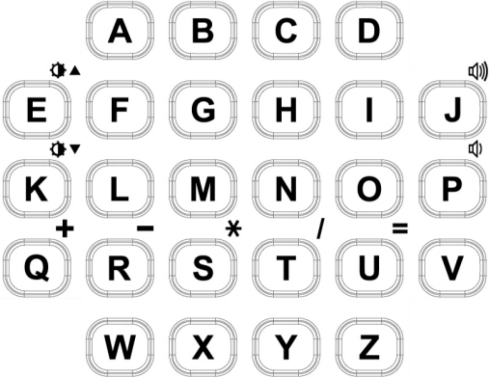
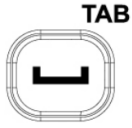
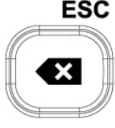

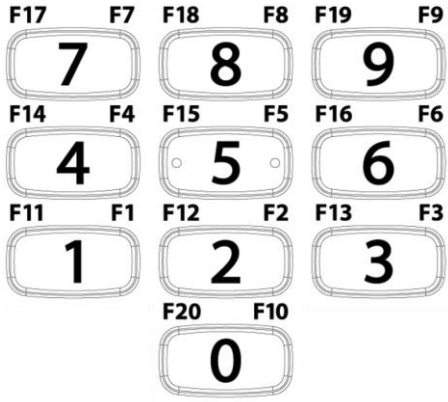



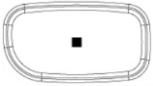

Key	Description
P1 / P2 SOFT_LEFT / SOFT_RIGHT 	Programmable keys, <ul style="list-style-type: none"> • P1 is the AppSwitch key by default. • P2 is the Back key by default.
Scan (Orange) SCANNER_F 	Scan the barcode
CTRL / ALT 	In Default input mode <ul style="list-style-type: none"> • Activates the CTRL functions mode. • The C_t icon appears on the status bar. In Functions input mode <ul style="list-style-type: none"> • Activates the ALT functions mode. • The A_t icon appears on the status bar.





Using the Keypad

Key	Description
<p>Alpha keys</p> 	<p>In Default input mode</p> <ul style="list-style-type: none"> Inputs alphabet in uppercase or lowercase. (Depends on whether shift combination mode is activated or not.) <p>In Functions input mode</p> <ul style="list-style-type: none"> Inputs some math symbols (Q~U) Controls screen brightness and volume. (E, J, K, P) (Refer to Functions section for more detail.)
<p>Space / TAB</p> <p>SPACE / TAB</p> 	<p>In Default input mode</p> <ul style="list-style-type: none"> Space function <p>In Functions input mode</p> <ul style="list-style-type: none"> Tab function
<p>Backspace / ESC</p> <p>BKSP / ESCAPE</p> 	<p>In Default input mode</p> <ul style="list-style-type: none"> Backspace function <p>In Functions input mode</p> <ul style="list-style-type: none"> Escape function
<p>Power</p> 	<p>Turns on / off the device or screen</p>
<p>Numeric 0~9 / Function 1~20</p> <p>0~9 / F1~F20</p> 	<p>In Default input mode</p> <ul style="list-style-type: none"> Inputs 0 to 9. <p>In Functions input mode</p> <ul style="list-style-type: none"> Executes the function mapped to F1 to F10 <p>In Shift combination input mode</p> <ul style="list-style-type: none"> Executes the function mapped to F11 to F20

Using the Keypad

Key	Description									
Period <i>PERIOD</i> 	Inputs a period									
Symbol 	<p>Press once</p> <ul style="list-style-type: none"> Inputs a symbol you set. By default, '~' will be inserted. <p>Press twice</p> <ul style="list-style-type: none"> Provides a 3x3 grid on the screen with nine additional symbols. Choose a symbol you want. <table border="1" data-bbox="846 699 1117 957"> <tbody> <tr> <td> ~ <small>\u007e</small></td> <td>@ <small>\u0040</small></td> <td>- <small>\u002d</small></td> </tr> <tr> <td>£ <small>\u00a3</small></td> <td>: <small>\u003a</small></td> <td>€ <small>\u20ac</small></td> </tr> <tr> <td> <small>\u007c</small></td> <td>[<small>\u005b</small></td> <td>] <small>\u005d</small></td> </tr> </tbody> </table> <ul style="list-style-type: none"> You can change the configuration of the grid with Program Buttons. Refer to Symbol grid. <p>Press three times</p> <ul style="list-style-type: none"> Hides the grid 	 ~ <small>\u007e</small>	@ <small>\u0040</small>	- <small>\u002d</small>	£ <small>\u00a3</small>	: <small>\u003a</small>	€ <small>\u20ac</small>	 <small>\u007c</small>	[<small>\u005b</small>] <small>\u005d</small>
 ~ <small>\u007e</small>	@ <small>\u0040</small>	- <small>\u002d</small>								
£ <small>\u00a3</small>	: <small>\u003a</small>	€ <small>\u20ac</small>								
 <small>\u007c</small>	[<small>\u005b</small>] <small>\u005d</small>								
Shift / Lock (Yellow) 	<p>Toggle key for Shift combination input mode. The functions shown on the keypad in yellow will be inputted in Shift combination input mode.</p> <p>Press once</p> <ul style="list-style-type: none"> Activates Shift combination input mode. The  icon appears on status bar. ex)  <p>Press twice</p> <ul style="list-style-type: none"> Maintains the Shift combination input mode. The  icon appears on status bar. ex)  <p>Press three times</p> <ul style="list-style-type: none"> Back to default input mode. 									







Using the Keypad

Key	Description
<p data-bbox="224 491 334 520">Fn (Blue)</p>  A black rectangular key with rounded corners and the text "Fn" in white.	<p data-bbox="743 300 1166 329">Toggle key for functions input mode.</p> <p data-bbox="743 338 1511 407">The keycode or function shown on the keypad in blue will be inputted in functions input mode.</p> <p data-bbox="743 453 873 483">Press once</p> <ul data-bbox="797 489 1260 558" style="list-style-type: none"><li data-bbox="797 489 1214 518">• Activates Functions input mode.<li data-bbox="797 522 1260 558">• The  icon appears on status bar. <p data-bbox="743 600 878 630">Press twice</p> <ul data-bbox="797 636 1260 705" style="list-style-type: none"><li data-bbox="797 636 1260 665">• Maintains the functions input mode.<li data-bbox="797 669 1260 705">• The  icon appears on status bar. <p data-bbox="743 747 948 777">Press three times</p> <ul data-bbox="797 783 1162 812" style="list-style-type: none"><li data-bbox="797 783 1162 812">• Back to default input mode.
<p data-bbox="224 884 298 940">Enter ENTER</p>  A rectangular key with rounded corners, outlined in black, with the text "ENTER" and a return symbol (a horizontal line with a hook pointing down and left) below it.	<p data-bbox="743 989 906 1018">Enter function</p>



Using the Keypad

Use the Buttons

Functions

Function	Description	Numeric Keypad	Alpha-Numeric Keypad
	Volume down	Alpha + Right	Fn + P
	Volume up	Alpha + Down	Fn + J
	Display brightness down	-	Fn + K
	Display brightness up	-	Fn + E
	Keyboard backlight brightness down	Alpha + Up	-
	Keyboard backlight brightness up	Alpha + Left	-

Screenshot

	Numeric	Alpha-Numeric
Key Combination	Power + P1 (SOFT_LEFT)	
Figure		

Using the Keypad

Program Buttons

Key mapping

Most buttons on the PM352 except power button can be optimized as you want. To map the button to other functions from default,

1. Navigate to **EmKit**  > **Program Buttons**.
2. Tap **SMART REMAP**. And press a button you want to remap.

Figure 40 Program Buttons - button list



Note: SCANNER_B indicates the trigger button on the gun handle.

3. Choose a behavior you want to use among the tabs.
4. Tap **APPLY**.

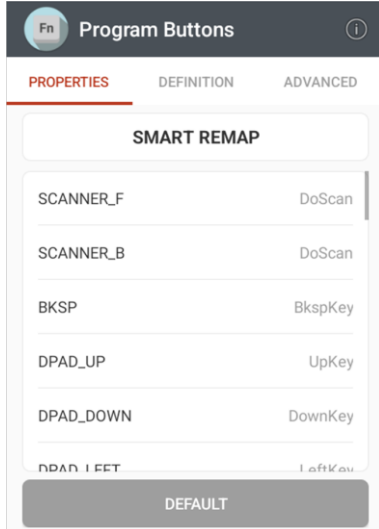
Using the Keypad

Symbol grid

You can set the grid configuration of Symbols key in keypad with Program Buttons. To set the grid,

1. Navigate to **EmKit**  > **Program Buttons** > **ADVANCED** tab.

Figure 41 Program Buttons - symbol grid

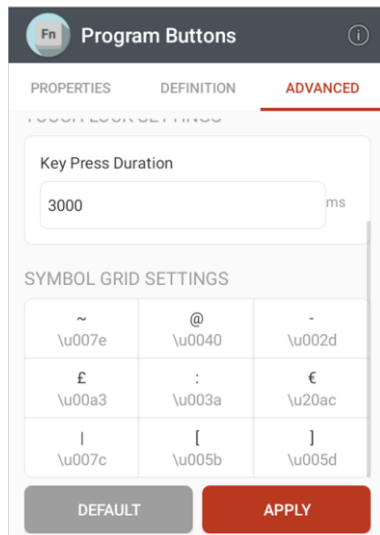

2. Tap a cell of the grid you want to change.
3. Input the Unicode of the desired symbol in the dialog.
4. Tap **OK**.
5. After setting up the symbol grid, tap Apply on the bottom to save the changes.



Note: To find the Unicode, see [this page](#) of Wikipedia.

Camera





To use the camera, open App drawer and tap Camera application .

Figure 42 Camera main screen

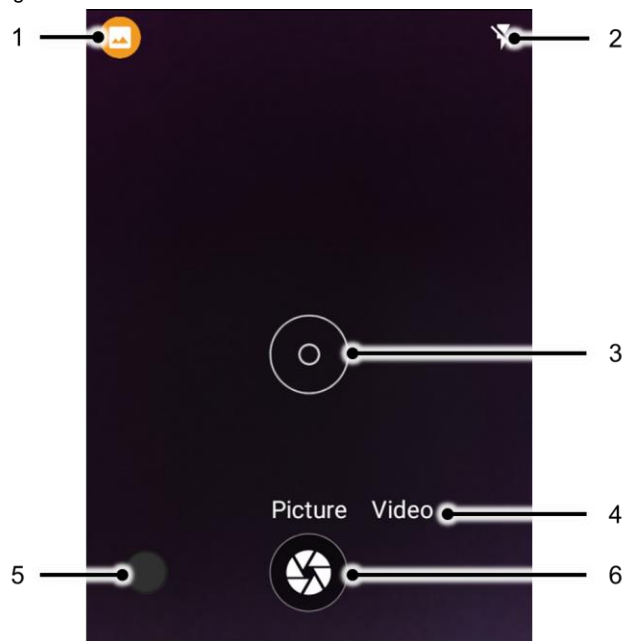

No	Name	Description
1	Modes	Select a mode depending on the target (normal / QR code) Or access advanced camera options
2	Advanced camera option	 : Always turn off the flashlight  : Turn on or off the flashlight automatically  : Always turn on the flashlight
3	Focus zone	You can change the focusing area by touching the other area
4	Picture / Video	Swipe or tap to change the mode (Picture / Video)
5	Gallery	Tap to see the recently taken pictures
6	Shutter button	Take a picture or recode a video

Scanner

Scanner is placed on the top of the device. Optimize the scanner settings for working environment and improve the efficiency.

Turn on / off the Scanner

The scanner is turned on by default. You can check the scanner status by the icon  on the status bar. If the icon displays, the scanner is turned on.

If the scanner is turned off, follow the steps turn it on.



1. Go to **EmKit**  or **Settings**  and tap **ScanSettings**.
2. Tap toggle button to turn on/off the barcode scanner.
3. Check if the scanner icon  is placed on Status bar.

Figure 43 Turn on scanner



Scanner

ScanSettings

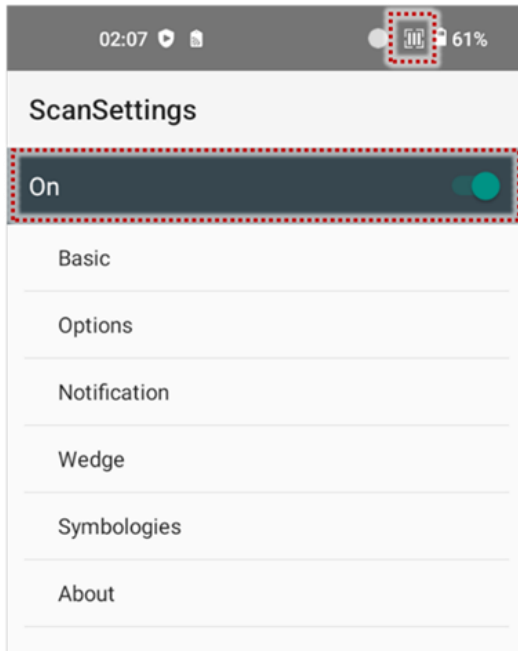
When the scanner is turned on, scanner setting menus will be displayed. **ScanSettings** consists of

- Basic
- Options
- Notification
- Wedge
- Symbologies
- About

Basic

Control the scanning options and wedge mode options.

1. Scanning

- Change the scanner’s trigger timeout and set scan mode (single / auto / continuous scan).
- Enable or disable the TouchScan, which is a software scanner button. Place a scan icon in any position and tap the icon to read a barcode.

Figure 45 ScanSettings - Basic

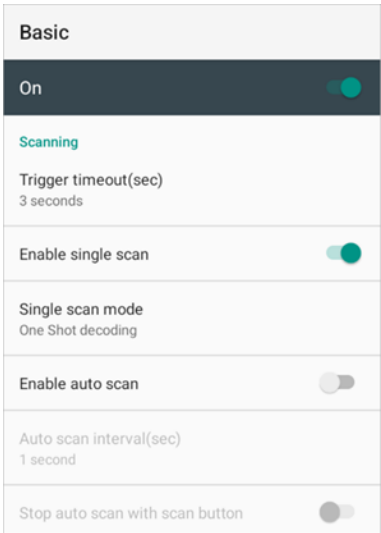
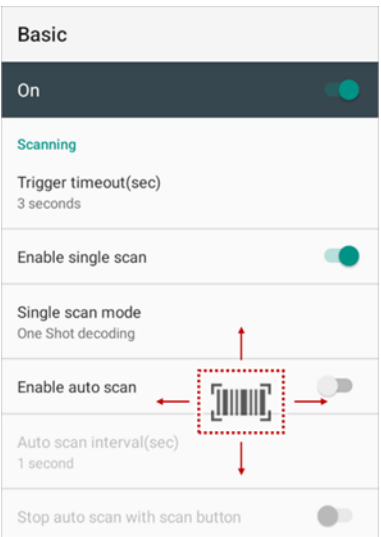

Figure 44 ScanSettings - TouchScan



Scanner

2. Wedge mode

- Change the result type of decoded data among the below list.
 - User Message
 - Keyboard Event (Multiple)
 - Keyboard Event (Single)
 - Clipboard (KEYCODE_PASTE)
 - Clipboard (Ctrl + V)
 - Intent Broadcast
 - Custom Intent
- Set Terminator as,
 - None
 - Space
 - Tab
 - LF
 - Tap & LF

Options

Enable / Disable the center window, Aimer, Illumination. And set scanner decoding settings.

Figure 46 ScanSettings - Options

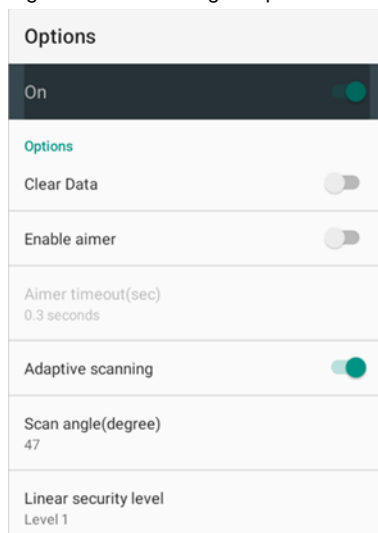

Scanner

Notification

Control the beep sound, LED and vibration option when scanning the barcode.

Figure 47 ScanSettings - Notification

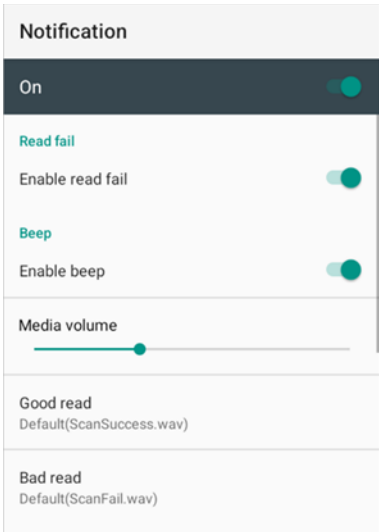

Scanner

Wedge

Set below items in Wedge settings

- Barcode ID
- AIM ID
- Group separator
- Prefix
- Suffix
- Character set
- Extended Wedge

Figure 48 ScanSettings - Wedge

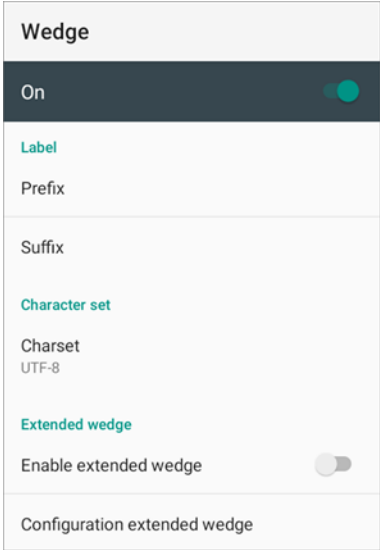

Scanner

Extended wedge

PM352 supports Extended wedge that allows to edit the decoded data. Tap **Enable extended wedge** toggle switch and then set a rule in **Configuration extended wedge**.

Figure 49 ScanSettings - Extended wedge

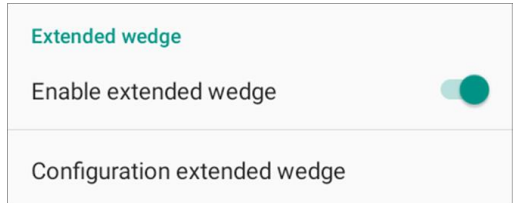

For example, make a rule that add a string *"Point Mobile"* at the start of decoded data whenever decoding CODE128.

1. Tap **Style** (1) and select **Condition** (2).

Figure 50 Extended wedge example_1

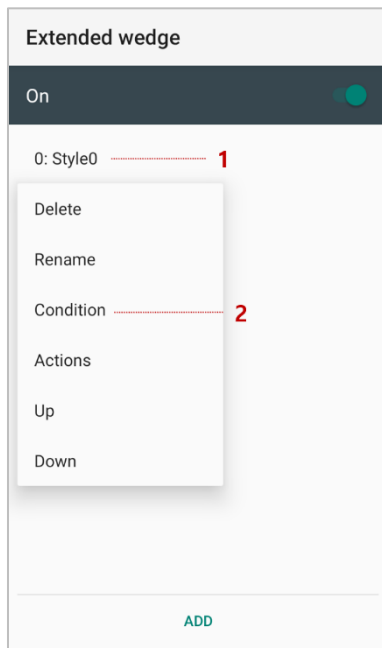

Scanner

- 2. Tap **Symbologies** and select **CODE128** among the symbologies.

Figure 51 Extended wedge example_2

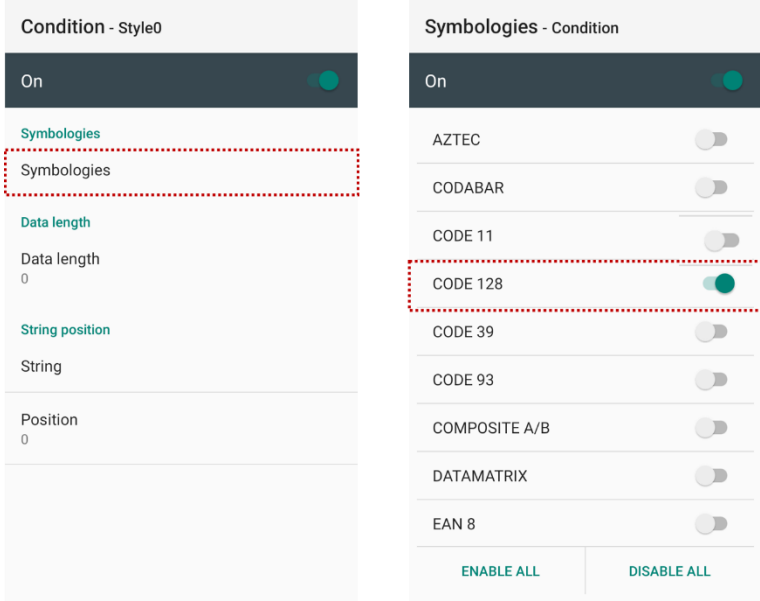

- 3. Tap **Style (1)** and select **Actions (2)**.

Figure 52 Extended wedge example_3

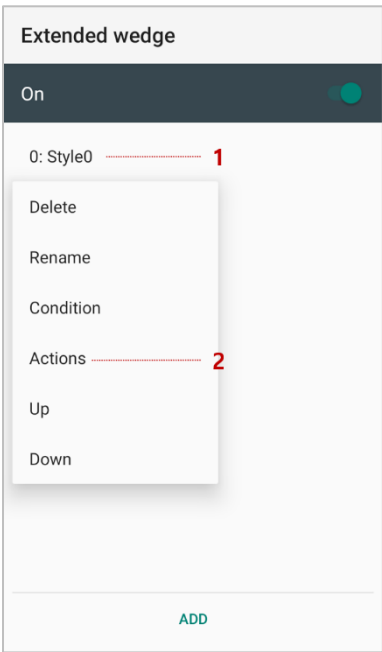

Scanner

- 4. Tap **ADD** and select **Move to start** to point the start of the decoded data.

Figure 53 Extended wedge example_4

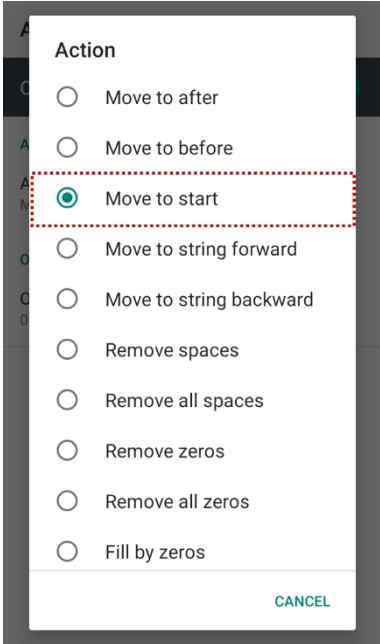

- 5. Add another action of which action type is Send string. Set value as "Point Mobile".

Figure 54 Extended wedge example_5

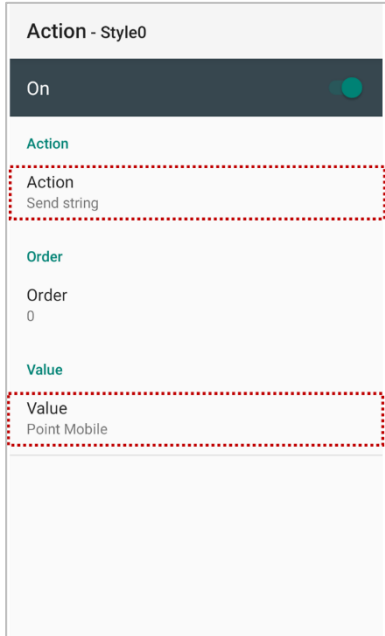

Scanner

6. "Point Mobile" string will be added to decoded CODE128 data.

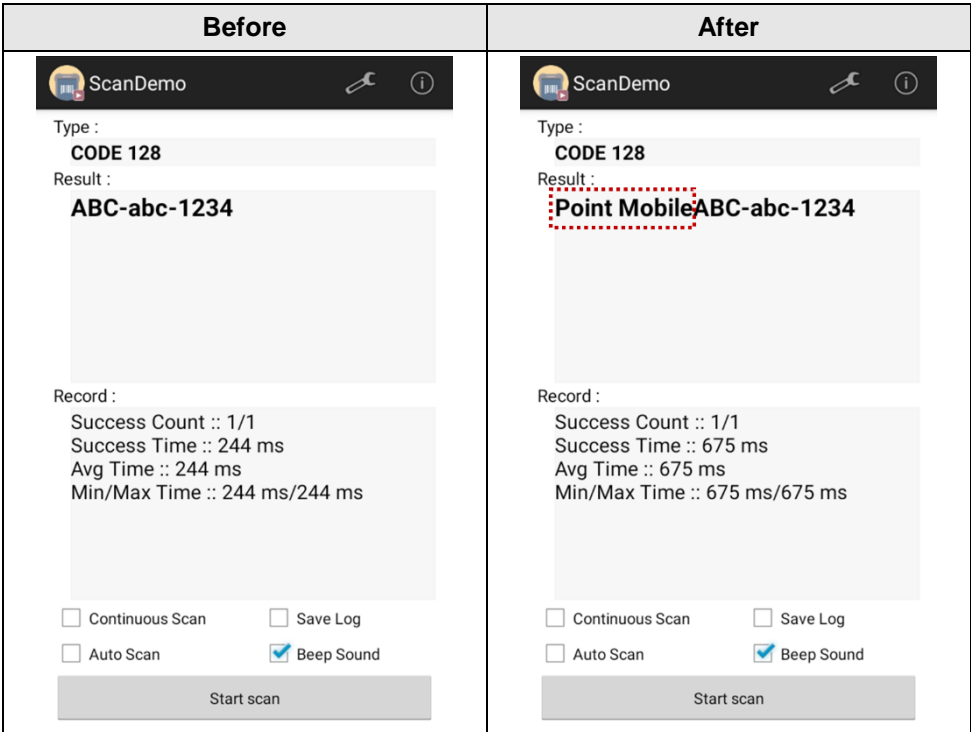

Scanner

Symbologies

Enable or disable the specific symbology or set detail options. By tapping each symbology name to access detail options.

Figure 55 ScanSettings - Symbologies

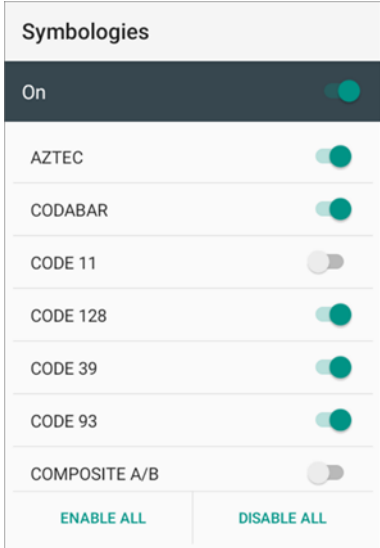

About

Find the scanner information or restore the scanner settings to default.

Figure 56 ScanSettings - About

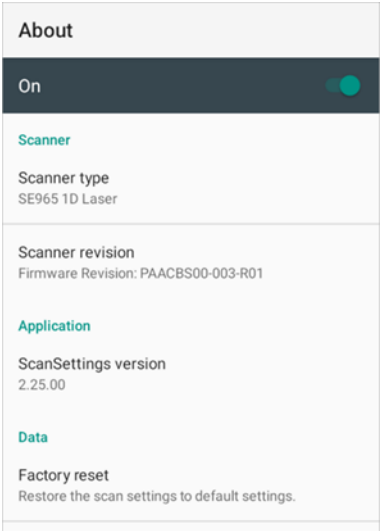

Scanner

Scan a Barcode

Point the scanner at the barcode and press the scan button on the device or gun handle. If another button is set as scan trigger using Program Buttons (Refer to [Use the Keypad – Program Buttons](#)), it can trigger the scan action, too.



Note:

If you set the single scan mode as Press decoding or Release decoding, it may require another button pressing mechanism to trigger scanning. Refer to [Single Scan Mode article](#) for more detail.

SE965 Scanner SKU

Aim the middle of the barcode so that the aimer is cover the entire barcode length.

Figure 57 Aiming barcode (SE965)



SE4100 Scanner SKU

Center the green dot aimer over the barcode. The entire barcode must be inside the illumination square.

Figure 58 Aiming barcode (N6703)

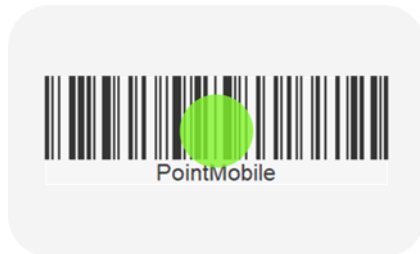

SE4750SR Scanner SKU

Center the cross-hair laser aimer over the barcode. You can tilt the aimer slightly for a comfortable angle to scan.

Figure 59 Aiming barcode (SE4750SR)



Scanner

ScanDemo

Using ScanDemo app, demonstrate scanning feature.

1. Execute **EmKit**  > **ScanDemo**.
2. Scan a barcode by pressing the scan button on the device or tapping **Start scan** button on the screen.
3. Find scan result

Figure 60 ScanDemo



Wireless

Mobile Network

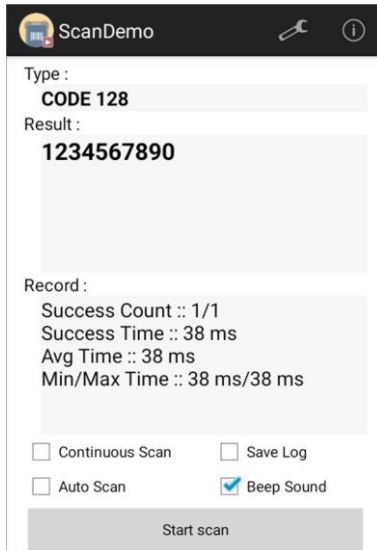

Note: Mobile network is supported on PM352 WWAN (LTE) SKU only.

To connect mobile network, SIM card is required. Insert SIM card first referring [Install SD & SIM cards](#).

After inserting the SIM card, reboot the device. When network is connected, a network icon will be appeared on the status bar.

Figure 61 Mobile network icon

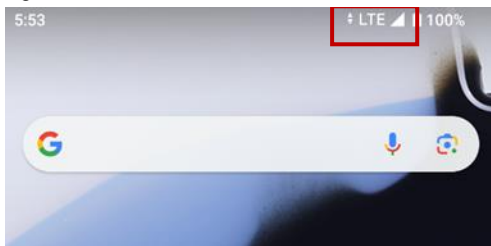

- **LTE network icon:** LTE

Find network information and adjust the network settings in **Settings**  > **Network & internet** > **SIMs**.

Figure 62 Mobile network setting



Wireless

Wi-Fi

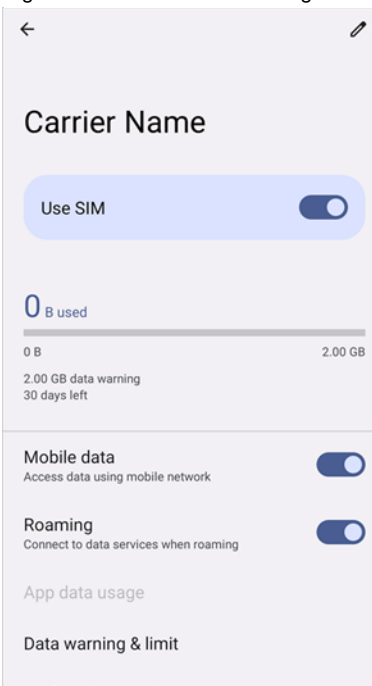
To turn on and connect a Wi-Fi,



1. Go to **Settings**  > **Network & internet** > **Wi-Fi**.
2. Tap toggle button to enable Wi-Fi.
3. Device searches for nearby Wi-Fi signals and lists them in order of signal strength.
4. Select a Wi-Fi SSID to connect.
5. The message **Connected** under the SSID means the device complete to connect to the Wi-Fi.

Figure 63 Wi-Fi connected

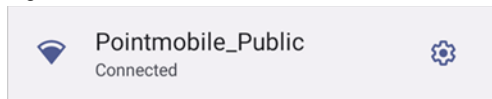

 **Note:** There are Open Wi-Fi network and Secured Wi-Fi network. You can tell those apart by lock icon (🔒) in the nearby Wi-Fi list.

To connect the secured Wi-Fi network, you need to enter the password.

Figure 64 Open Wi-Fi Network

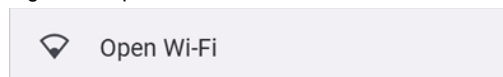
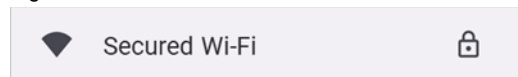
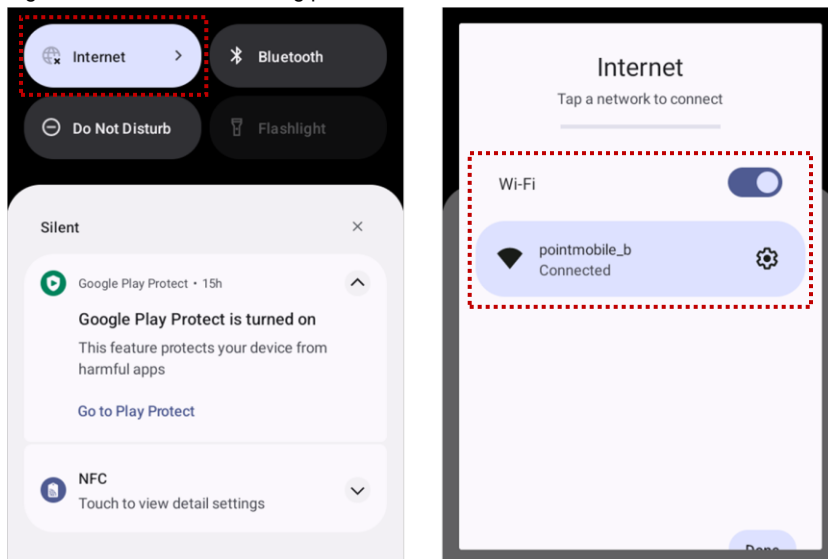

Figure 65 Secured Wi-Fi Network



If there is a saved Wi-Fi network, simply turn on the Wi-Fi through the Quick setting panel. The saved network will be connected automatically.

Figure 66 Wi-Fi in Quick setting panel



Wireless

Bluetooth

Turn on / off

Bluetooth is turned off as default. There are two ways to turn on the Bluetooth,

- Open quick setting panel and enable Bluetooth 

Figure 67 Bluetooth in Quick setting panel



- Go to **Settings**  > **Connected devices** > **Pair new device**

Pair and Connect

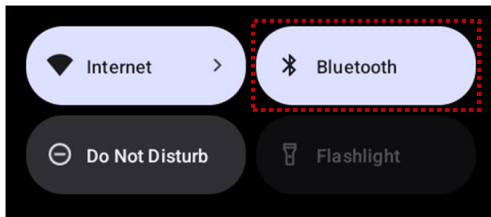
To connect with a new device,

1. Go to **Settings**  > **Connected devices**.
2. Tap **Pair new device**.
(Bluetooth will be turned on automatically)
3. Select the device you want to pair among **Available devices** list.

Figure 68 Bluetooth available devices



4. Follow instructions on the screen (Pairing code or pairing confirmation dialog) and tap **PAIR**.

Wireless

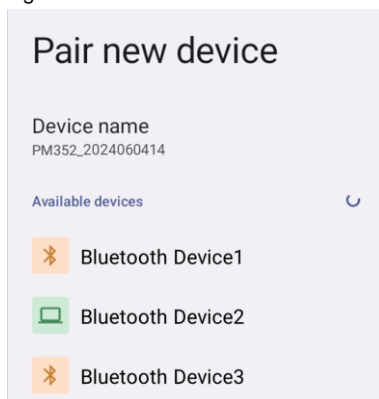
5. When the connection is succeeded, the connected device name is listed under the **Other devices** list.

Figure 69 Bluetooth currently connected

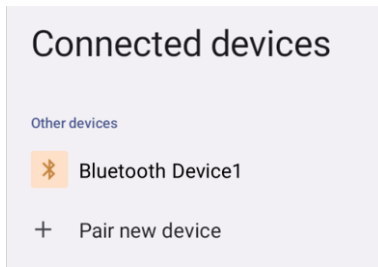

To connect a device previously connected, select the device name from the **Saved devices** list.

Figure 70 Previously connected devices

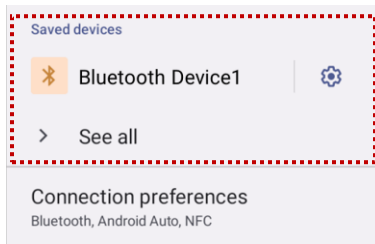

Unpair and Disconnect

To unpair the device, select the name of the device you want to unpair from the **Other devices** list and tap **FORGET** .



Or tap **DISCONNECT**  to disconnect only and not unpair.

Figure 71 Forget device

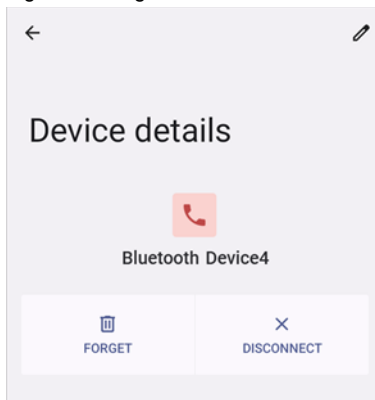

Wireless

Change the Bluetooth device details

Tap the  icon next to the device name to see device details.

If the device you want is not listed under the **Saved devices**, tap **See all**.

Figure 72 Bluetooth device detail

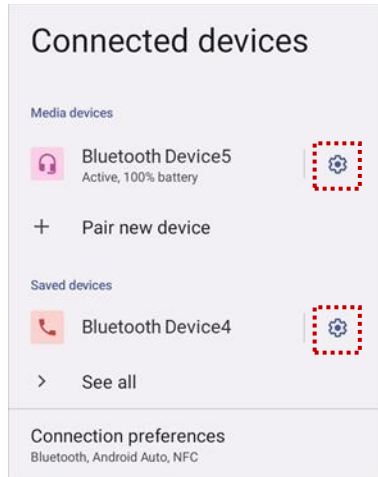

- To change the device's name, tap  on the top of the screen
- Turn other settings on or off (Available on some devices)

Wireless

NFC

PM352's NFC antenna is located on the rear-top side of the device. Bring the NFC tag close to the antenna location as Figure 74.

NFC feature is enabled by default. But if NFC does not work, make sure the NFC is enabled from the **Settings**  > **Connected devices** > **Connection preferences** > **NFC**.

Figure 73 PM352 NFC tapping area

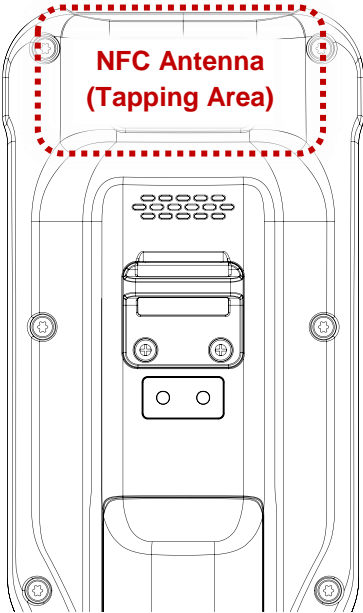

Figure 74 NFC tapping



System Maintenance

System Information

There are two ways for checking system information, on **settings** and on **EmKit**.

On Settings

Go to **Settings**  > **About phone**. Following information can be found.

- Device name
- Legal information & Certificates
- Model & SIM status
- Hostname
- IMEI
- Android version
- IP address
- Wi-Fi MAC address
- Bluetooth address
- Build number

On EmKit

Go to **EmKit**  > **System Information**. Following information can be found.

- Processor information
- Version information (Android version, OS image version, SDK version, etc.)
- Manufacturer information (Serial number, Part number, etc.)
- Device information (Scanner, Audio, Display, etc.)
- Battery information (Battery charging status, etc.)
- App version information (Version of EmKit apps)

System Maintenance

Check Device Health

EmHealthReport is a solution that provides the device's battery and eMMC health.

Monitor the battery and eMMC status to foresight their lifetime or find the cause when there is a battery problem such as cannot charge the device or rapid battery discharge.

To use, open **EmKit**  and launch **EmHealthReport**. You can see the simple device health information on the main screen. To find detailed information, tap each blue arrow on the right side of the screen.

Figure 75 EmHealthReport



- **Battery Health**
 - Battery Serial Number
 - Battery Age
 - Battery Level
 - Battery First Use Date
 - Battery Voltage
 - Battery Temperature
 - System Temperature
 - Battery Manufacture Date
 - Smart Charging Mode
(Refer to [Smart Charging](#))
- **eMMC Health**
 - Pre-EOL Information
 - Device life time estimation type A
 - Device life time estimation type B

System Maintenance

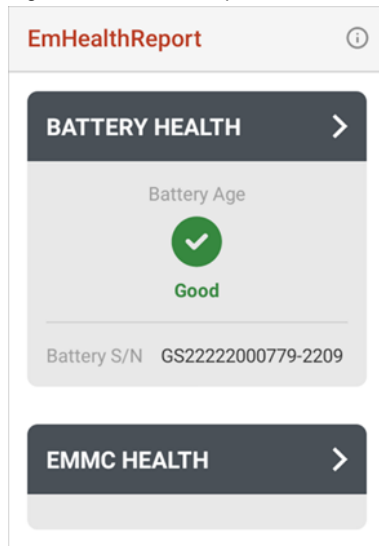
OS Update

Periodic update improves the performance of the device. Point Mobile provides up-to-date OS version via Service Portal and FOTA. Update the device via storage, OTG port, and FOTA server. Depending on the workspace environment, choose more suitable method.



Notice: Please backup your data before starting the update process.

OS update via storage

To update the OS using storage,

1. Download an OS image file into the root folder of microSD card or device internal storage.
2. (In case of using SD card) Insert SD card to the device and then turn the device on.
3. Go to **Settings**  > **System** > **System Update**.
4. Check if the OS image file shows up under **AVAILABLE VERSIONS**.

Figure 76 OS update via storage



5. Tap **UPDATE** to start the update process

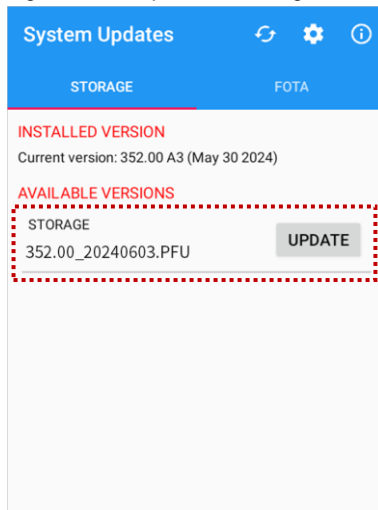

Note: If the OS image file doesn't show up in **AVAILABLE VERSIONS**, check the file is placed in the root folder of storage. System only can recognize the file in the root folder.

System Maintenance

OS update via OTG port

PM352 supports the USB OTG feature.

1. Prepare a formatted USB flash drive for OS update.
2. Copy an OS image file to the root folder of the flash drive.
3. Connect the flash driver to the PM352.
4. Go to **Settings**  > **System** > **System Update**.
5. Check if the OS image file shows up under **AVAILABLE VERSIONS**.
6. Tap **UPDATE** to start the update process.

OS update via FOTA

If PM352 can connect to a network, use the FOTA server for the update.

1. Connect the device with a network.
2. Go to **Settings**  > **System** > **System Update**.
3. Tap **FOTA** tab or Swipe left to move to **FOTA** tab.
4. If there is an OS version newer than device's one, the server shows the new OS information.

Figure 77 OS update via FOTA



System Maintenance

5. Tap **Download**.
6. Tap **OK** on the **OS Update** dialog to start to download the OS image file.
7. To complete the update, rebooting is required.
Tap **OK** on the **Restart required** dialog to restart the device.

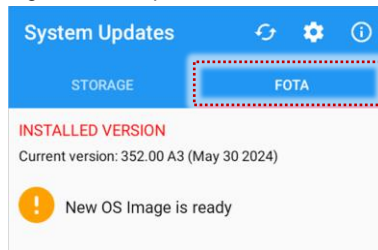
i **Note:** Basically, OS update via FOTA works over Wi-Fi or Ethernet only. To enable the OS update over Mobile Network too, uncheck the setting value in FOTA Settings. Downloading over the Mobile network may result in additional charges.

Figure 78 FOTA Settings

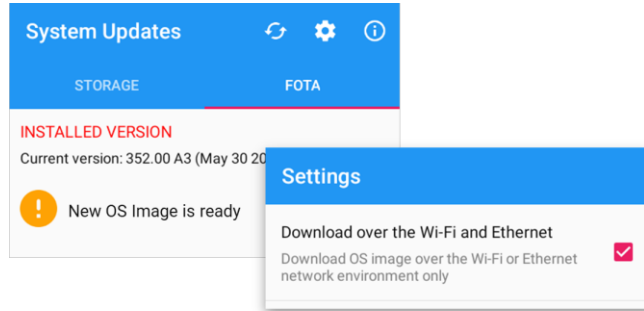

System Maintenance

Factory Data Reset

When PM352 work abnormal or there is a need to reset the device, follow the steps below to perform a factory data reset.



Caution: Factory data reset will erase all personalized settings and data saved in the device, such as Google account, apps, user data, etc. And factory data reset cannot undo.

Factory data reset via Settings app

If the device can be turned on and access **Settings**,

1. Navigate to **Settings**  > **System** > **Reset options**.
2. Tap **Erase all data (factory reset)**.
3. After being aware that factory reset will erase all data from the internal storage, tap **Erase all data**.

Figure 79 Factory data reset



4. Tap **Erase all data** again to start the factory reset process.

Accessories

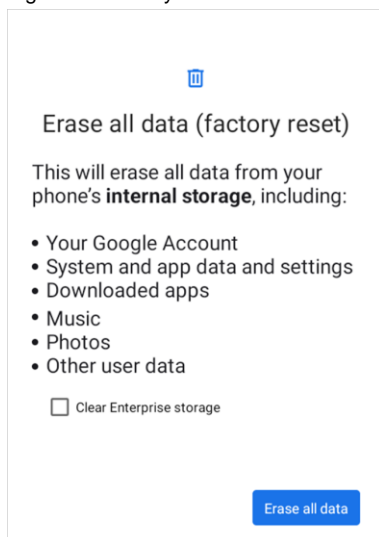
PM352 supports below accessories and they can be used in common with PM351. All accessories except hand strap are sold separately.

Category	Accessory Name	Usage
Handy carry	Hand strap	Carries PM352 easily
Sled type	Gun handle	Provides an ergonomic trigger button (Programmable button)
Charging cradle	SSC (Single Slot Cradle)	Charges one PM352 and one PM352 battery Provide USB type C port
	2SC (2 Slot Cradle)	Charges two units of PM352
	4SBC (4 Slot Battery Cradle)	Charges up to four pieces of PM352's batteries

Hand Strap

The hand strap is enclosed in the PM352 standard package. Attach the strap and you can grab the device more firmly.

Figure 80 Hand strap

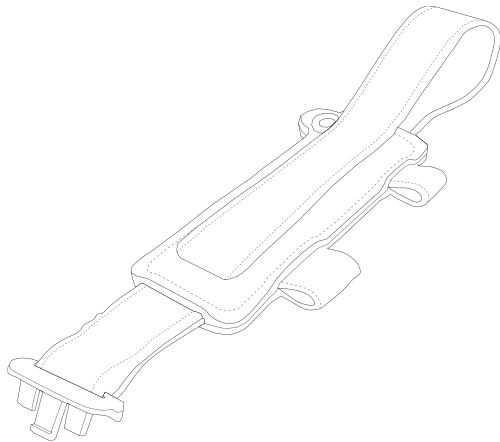

Accessories

Attach hand strap

1. Insert the hand strap bracket to the hand strap hole on the bottom of the device.

Figure 81 Attach hand strap_1

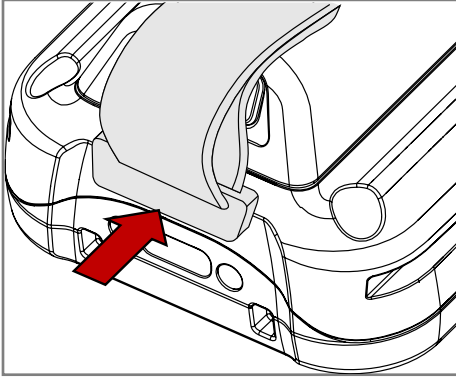

2. Pass the other end of the strap through the hand strap hole on the rear-center side of the device.

Figure 82 Attach hand strap_2

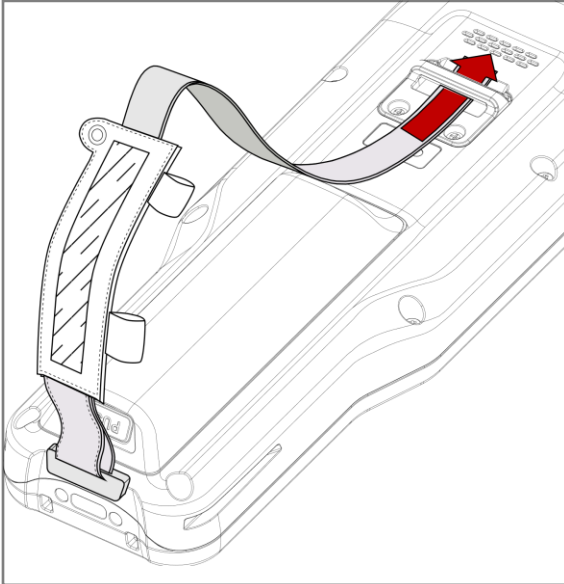

3. Pull the strap and attach the Velcro at the desired length.

Accessories

Gun Handle

Attach & Use gun handle

Attach PM352 to the gun handle from top side, and push the bottom firmly.

Figure 83 PM352 Gun

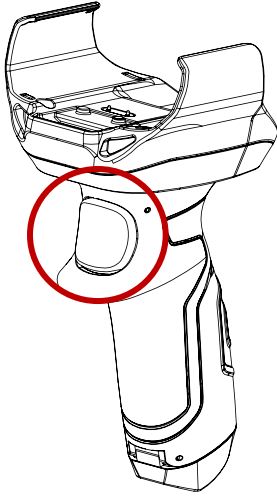
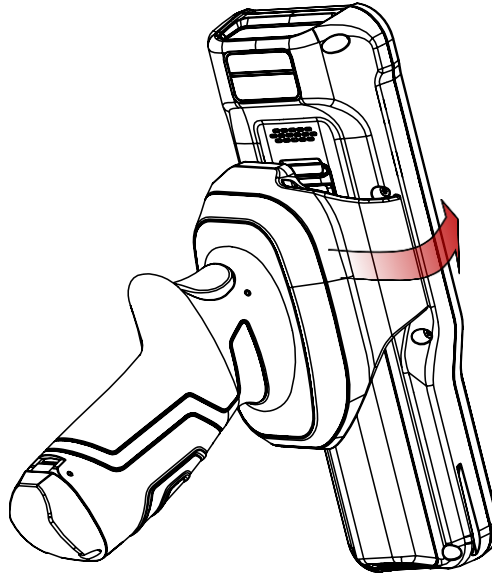

Figure 84 Attach PM352 to gun handle



With gun handle, you can use additional programmable button. The button is used for triggering scanner usually.

If you want to change the function mapped to the trigger button, access [Using the Keypad - Program Buttons](#) and set **SCANNER_B** to the desired function.

Attach hand strap

A hand strap is enclosed in the gun handle package. Attach the strap and carry the device more comfortably.

Figure 85 Gun handle - hand strap

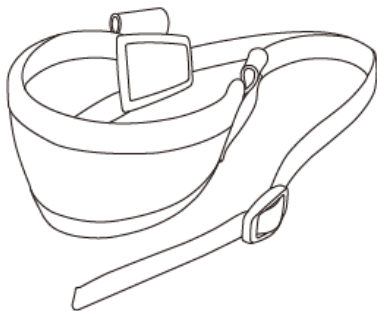

Accessories

1. Thread the strap through the hole on the bottom side of the retention fixture.

Figure 86 Gun handle - Attach hand strap_1

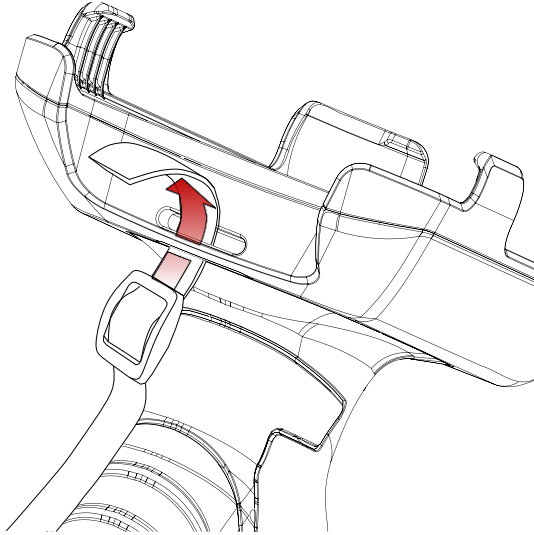

2. Slide the strap through the buckle at the appropriate length.

Figure 87 Gun handle - Attach hand strap_2

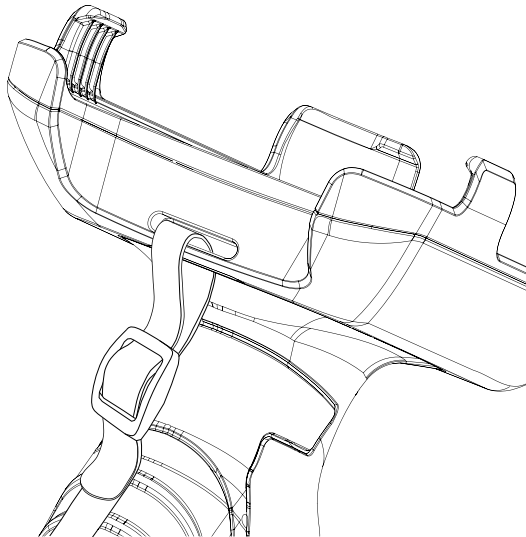

Accessories

Charging cradle



Note: All charging cradles can be used in common with PM351.

Single Slot Cradle (SSC)

Figure 88 SSC

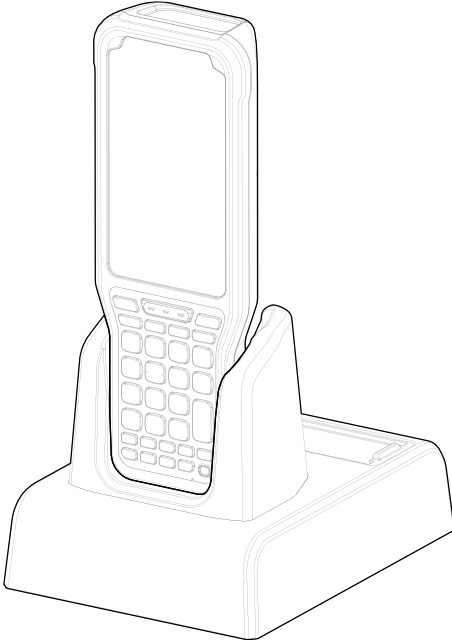

SSC can charge the followings.

- PM352 only
- PM352 + Gun handle mounted
- PM352 battery

For more detail, find the SSC Quick start guide.

Accessories

2SC (2 Slot Cradle)

Figure 89 2SC

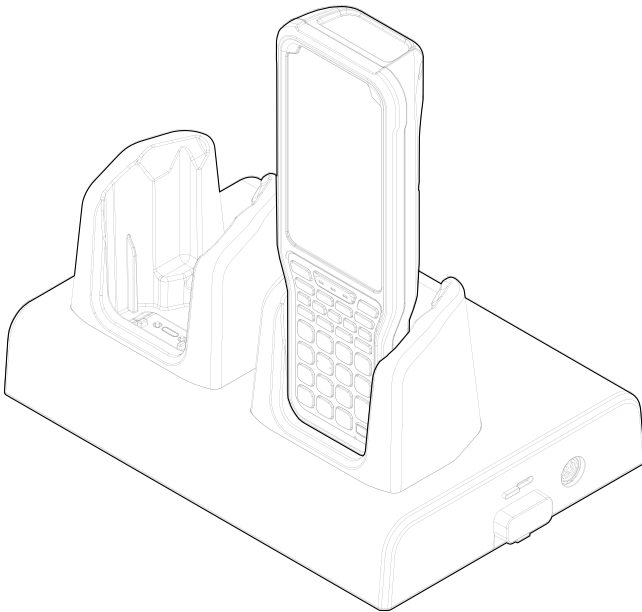

2SC has 2 device slots so it can charge up to two units of PM352 simultaneously. PM352 with a gun handle equipped can be charged using 2SC.

And the cradle can be assembled with up to two more 2SC for share cradle. It can become 4SC (Assemble two pieces), and 6SC (Assemble three pieces).

For more detail, find 2SC Quick start guide.

Accessories

4SBC (4 Slot Battery Cradle)

Figure 90 4SBC

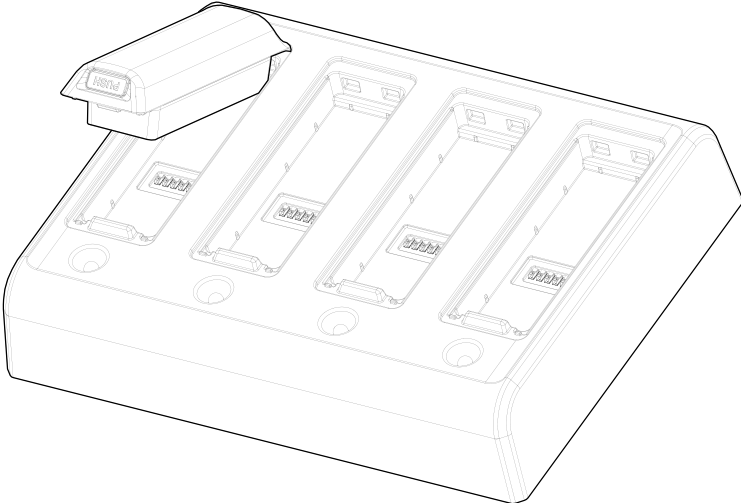

4SBC has 4 battery slots so it can charge up to four pieces of PM352’s battery simultaneously.

For more detail, find 4SBC Quick Start Guide.

Safety Information

Battery Safety Information

Follow the battery safety guidelines for safe usage, storage, and disposal of Li-ion batteries. Improper battery use may result in a fire, explosion, or other critical hazards.

Battery Safety Guidelines

- Use only Point Mobile approved batteries and charging accessories. Other batteries and chargers may damage the device or result in a fire, leakage, or other hazards.
- Do not expose the battery to excessive heat or cold.
- Do not use or store the battery in or near areas that might get very hot, such as in a parked vehicle, near a heat duct or close to other heat sources.
- Do not allow objects that may cause a short circuit, such as metal objects, corrosive substances, or liquids like water, to contact the battery.
- Do not disassemble, crush, bend, shred, press, or other actions that may damage or deform the battery.
- Do not use or replace the battery on the go or from a high location. Dropping may result in an explosion or fire.
- Do not put any labels, stickers, tags, etc. on the device or battery. Performance of the device or battery, such as sealing, drop, or tumble, could be affected.
- Close supervision is necessary when used near children to avoid the risk of injury.
- If battery leakage is observed, avoid any contact with the skin or eyes and properly dispose of the battery. If contact has been made, wash the affected area with water for 15 minutes and seek medical advice.
- If you notice any type of damage to the battery, such as swelling, dents, and leaks, stop using it immediately and contact Point Mobile.

Battery Charging Guidelines

- Charge the battery in a clean, cool, dry, and ventilated environment.
- Separate the charger from the battery as soon as possible when the battery is fully charged.
- Battery performance can degrade due to the stress of daily charging and discharging. Batteries typically need to be replaced after 300 to 500 charging cycles (full charge-discharge cycles) or when the battery capacity has been reduced to 70 ~ 80% of its original capacity. The actual number of charging cycles varies based on usage patterns, temperature, age, and other factors.

Safety Information

Battery Storage / Disposal Guidelines

- Store the batteries in a clean, dry and ventilated environment within ambient temperature ranges of $20\pm 5^{\circ}\text{C}$.
- For safety regulations, batteries are charged to below 20~30% of full capacity during production.
- When not using batteries for a long period, charge the battery for 30 minutes to 1 hour at least once every 6 months to prevent full discharge and keep the performance.
- Batteries should be stored separately when storing for long periods. Disconnect from any device, charger, or cradle.
- Dispose of used batteries promptly according to local disposal regulations.
- Do not dispose of the battery in fire. It may cause explosion.



Notice: *The battery is consumable. Point Mobile provides a warranty for the battery for 12 months after purchase. If you suspect the battery swelling, change the battery immediately and contact Point Mobile.*



Point Mobile. Co., Ltd.

Offline

Tel: +82-2-3397-7870~1

Fax: +82-2-3397-7872

Address: 26F, Building A, Gasan Publik,
178, Digital-ro, Geumcheon-gu, Seoul, Korea 08513

Online

Website: <https://www.pointmobile.com>

E-mail : pm_ta@pointmobile.com