



For Android™ 10

Enterprise Mobility

PM30

User Manual

Instruction

This manual provides information about basic features and using the PM30. Please read carefully before using your handy enterprise device and peripherals to ensure safe and proper use.

 **Note:** Screenshots in this manual may differ from actual screens.

Revision History

Revision	Date	Description
V01	04 Mar 2021	Initial release.

PM30 SKUs

The contents of this manual can cover the following SKUs.

SKU	Part Number	OS	RAM /Flash	Power	Data Capture	Network
SKU1	PM30G3K03DHE0F	Android GMS 10	4G/64G	3,250mAh, 4.4V battery	Scanner - N2601 Camera – Rear, Front camera	WiFi/BT
SKU2	PM30G6K03DHE0F			Wireless charging	NFC Fingerprint sensor	LTE, GPS, WiFi/BT

Table of Contents

INSTRUCTION	1
Revision History	1
PM30 SKUs	1
TABLE OF CONTENTS.....	2
GETTING STARTED	6
Device Parts	6
Product Standard Accessories.....	8
Install SIM & SD card.....	9
Charge the device.....	11
Battery specification	11
Charge with power adapter.....	11
Charging accessories	12
SSC.....	12
2SC	13
Wireless charging pad	14
PMBooster (Extended battery case)	14
LED indicator	15
Turn on & off PM30.....	16
Use a touch screen.....	17
LEARNING THE BASICS	19
Setup Wizard	19
Home Screen.....	20
Status bar	21
Status icons.....	21
Notification icons	22
Notification panel	22

Quick setting panel	23
Apps & Widget.....	24
App folder	24
App drawer	25
Favorites tray.....	25
Organize app in Home screen	26
Widget.....	26
Recently Used Apps	28
Call.....	29
Making a call.....	29
Answering a call	31
Contacts.....	32
Add a contact.....	32
Add a contact via dialer	32
Add a contact via contacts app.....	32
Contact detail.....	33
Message	34
MTP Connection with PC	35
Manage the Files	36
Lock the Screen.....	38
Fingerprint lock.....	39
Use the Buttons	41
Screen capture	41
Program buttons	41
Settings.....	43
Adjust display brightness	43
Adjust sound.....	43
Adjust font size	44
CAMERA	45
SCANNER	46

Turn on / off the Scanner	46
ScanSettings.....	47
Basic.....	47
Options	48
Notification.....	49
Wedge	50
Extended wedge.....	51
Symbologies	55
About	55
Scan a Barcode	56
ScanDemo	57
WIRELESS	58
Mobile Network (LTE SKU Only).....	58
Wi-Fi	59
Bluetooth.....	60
Turn on / off	60
Pair and Connect.....	60
Unpair and Disconnect	61
Change the Bluetooth device details	62
NFC (Near Field Communication).....	63
RFID	64
SYSTEM MAINTENANCE	65
System Information	65
On Settings.....	65
On EmKit	65
OS Update	66
OS update via storage	66
OS update via OTG port.....	67
OS update via FOTA	67
Factory Data Reset.....	69

Factory data reset via Settings app 69
 Factory data reset via recovery mode 70

ACCESSORIES 71

Gun Handle..... 71
 RF300 (UHF RFID Reader) 71
 Single Slot Cradle (SSC) 72
 2 Slot Cradle (2SC)..... 72
 Wireless Charging Pad 72
 PMBooster 73

SAFETY INFORMATION 74

Battery Safety Information 74

Getting Started

Device Parts

Figure 1 PM30 Front view

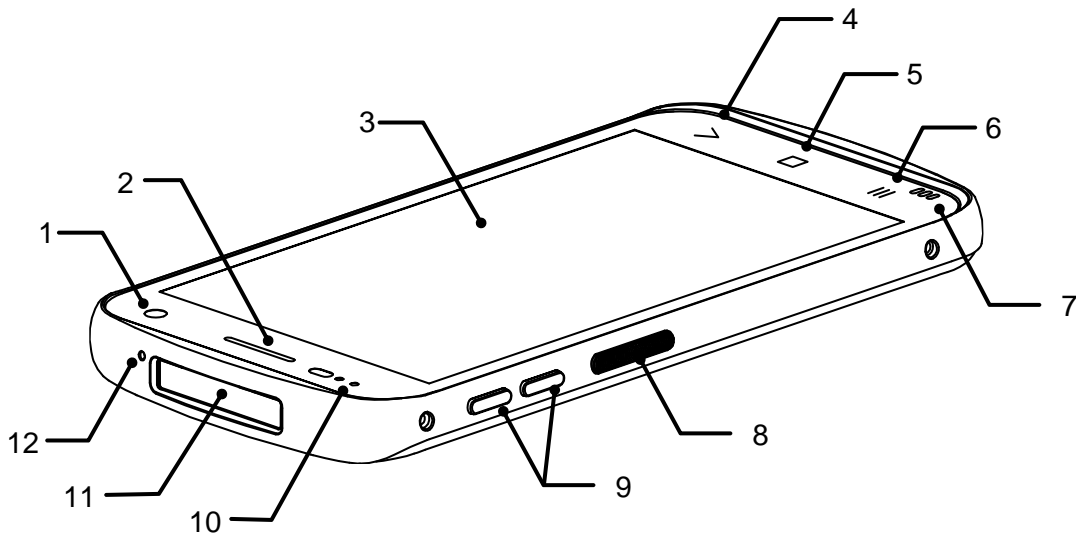

No	Name	Description
1	Front camera	Take a picture
2	Receiver	Use with making a phone call
3	Screen	Display all operating screen
4	Back button	Go back to previous screen
5	Home button	Go to home screen
6	Recent app button	List up the recently used apps
7	Speaker	Ring system sound
8	Push-To-Talk / Scan button	Use PTT function or scan a barcode by pressing (Programmable button)
9	Volume up & down button	Control the volume (Programmable button)
10	LED Indicator & Sensor	Indicate the power status and notification (Find more details in LED Indicator)
11	Scanner	Scan a barcode
12	Microphone (Second)	Use as Microphone with main microphone

Getting Started

Figure 2 PM30 Rear view

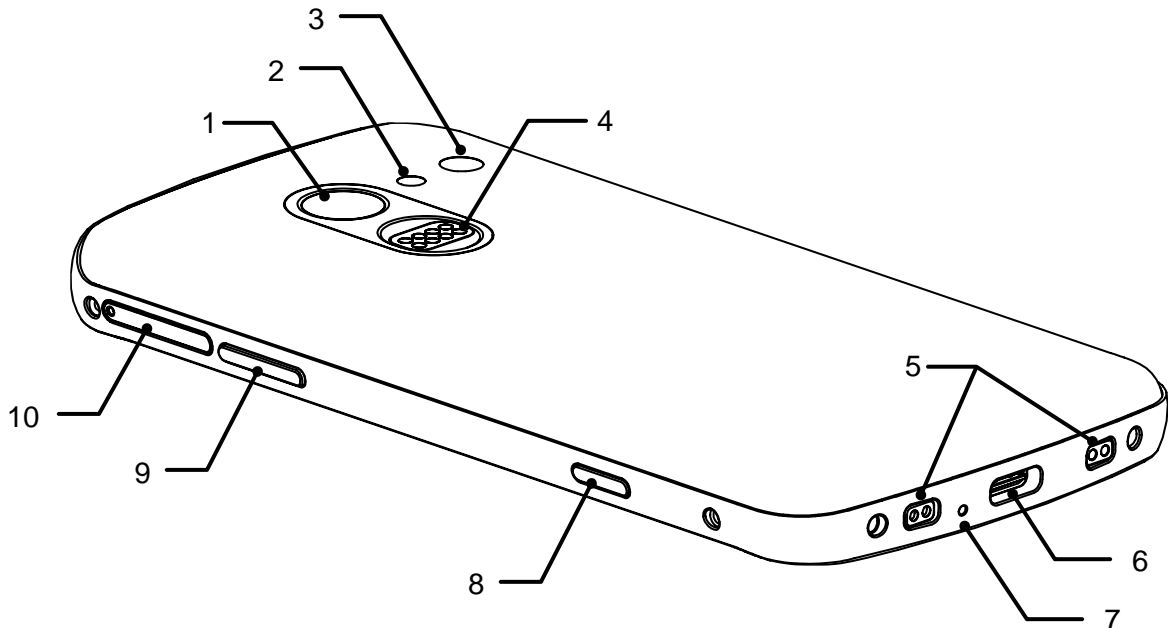





No	Name	Description
1	Fingerprint sensor	Use fingerprint for authentication
2	Flashlight	Use flashlight in camera or torch mode
3	Rear camera	Take a picture
4	I/O connector for sled type accessory	Connector for communication with a sled type accessory (RF300 or gun handle)
5	I/O connector for charging	Connector for cradle charging
6	USB Connector	USB Type C connector for charging and data communication
7	Microphone (Main)	Use as Microphone with second microphone
8	Power button	Turn on / off the device
9	Scan button	Scan a barcode by pressing (Programmable button)
10	Card tray	Insert a microSD card, and nano SIM card (LTE SKU only)

Getting Started

Product Standard Accessories

The following items are in the product box.

Accessory	Name
	AC/DC power supply
	Country plug
	USB type C cable
	Card tray eject pin
	LCD protection film



Note: The images may differ from the actual accessory.

Getting Started

Install SIM & SD card

PM30 supports

- microSD card
- Nano SIM card - LTE SKU (PM30G6K03DHE0F) only

Refer to the table to find out the difference.

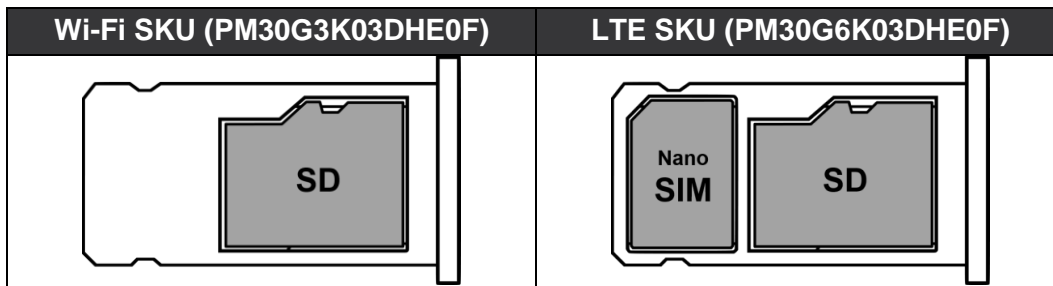

To install the cards,

1. Insert the sharp side of the card tray eject pin to the card tray hole of PM30, and then push until the card tray is slide out. Pull the card tray out.

Figure 3 Detach card tray

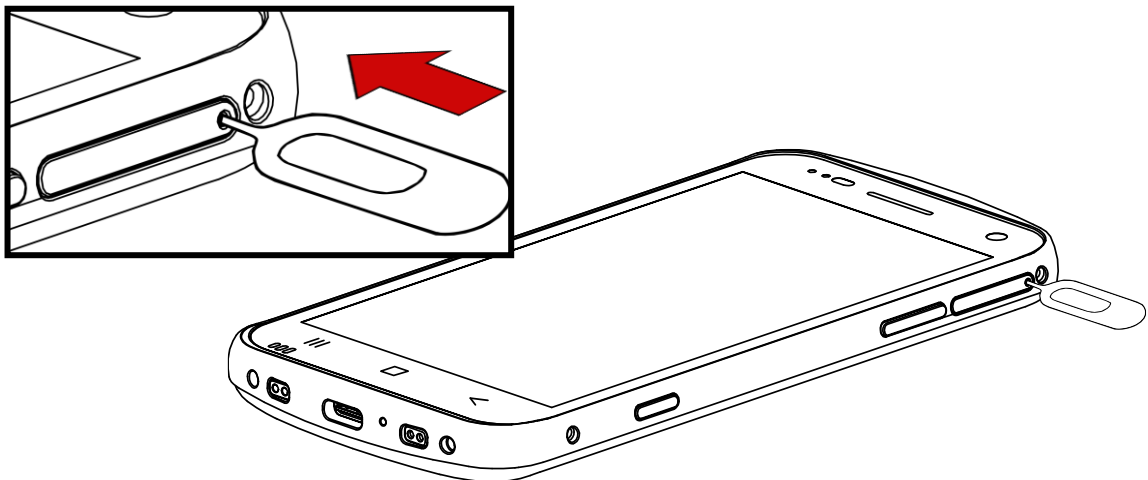

Getting Started

2. Insert the Nano SIM card and microSD card into the proper slot.
(Gold contact must be facing down.)

Figure 4 Card orientation

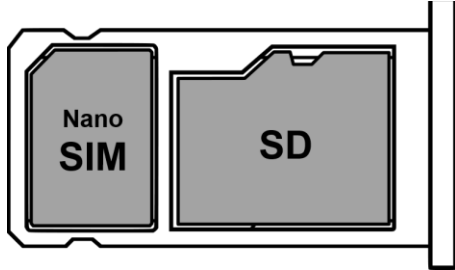

3. Put the card tray back into PM30.

Figure 5 Insert SIM card and SD card

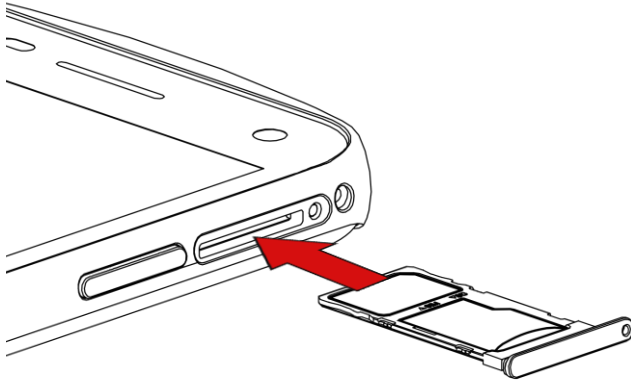

Getting Started

Charge the device

Before using PM30, charge the device enough to use. PM30 can be charged with power adapter or charging accessories (cradles, wireless pad, and PMBooster).

! **Caution:** Always use an original charger and cable from Point Mobile. Other chargers and cables may damage PM30. Also, make sure the charger and cables are not wet. Follow the [battery safety Information](#) for safety of using the battery.

Battery specification

- Capacity: 3250mAh / 4.4V
- Rechargeable battery (Non-removable)
- Charging time: About 2 hours (via power adapter)

Charge with power adapter

1. Assemble the country plug, AC/DC power supply and USB type C cable.
2. Connect the cable to the USB connector of PM30.
3. Provide power by plugging the power supply to the wall socket.

Figure 6 Charging PM30

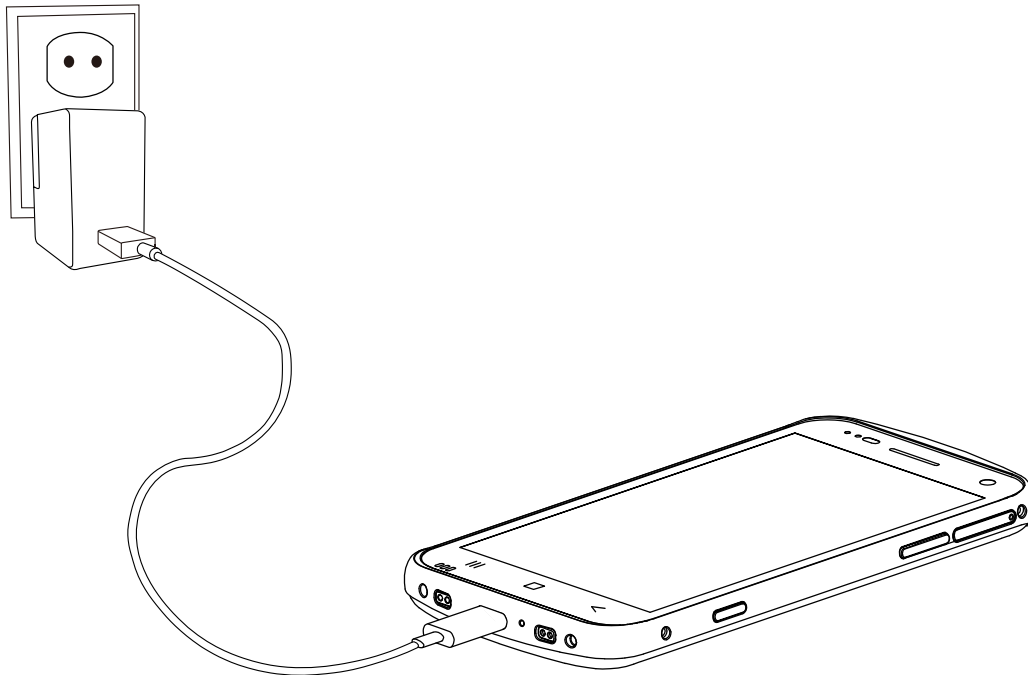

Getting Started

Charging accessories

There are four PM30 optional accessories for charging. SSC (Single Slot Cradle) and 2SC (2 Slot Cradle) are charging cradle, and wireless charger, and PMBooster. PMBooster can charge the PM30 only, and other accessories can charge the PM30 and its accessory as below table.

	2SC	SSC	Wireless charging pad
PM30	O	X	O
PM30 + Protective case	O	X	O
PM30 + PMBooster	O	X	X
PM30 + RF300	X	O	X
PM30 + Gun handle	X	O	X

SSC

SSC can charge a PM30 with a sled type accessory (Gun handle or RF300) mounted. To charge PM30 using SSC,

1. Assemble the power adapter and AC plug, and connect it to the cradle to provide power.
2. Install PM30 with sled type accessory mounted.

PM30 and RF300 will be charged simultaneously. So, make sure the charging animation is displayed on the PM30 screen and charging LEDs of the PM30 and RF300 light on. (Refer to [LED indicator](#) and RF300 User manual)

Figure 7 Charging PM30 + RF300 via SSC

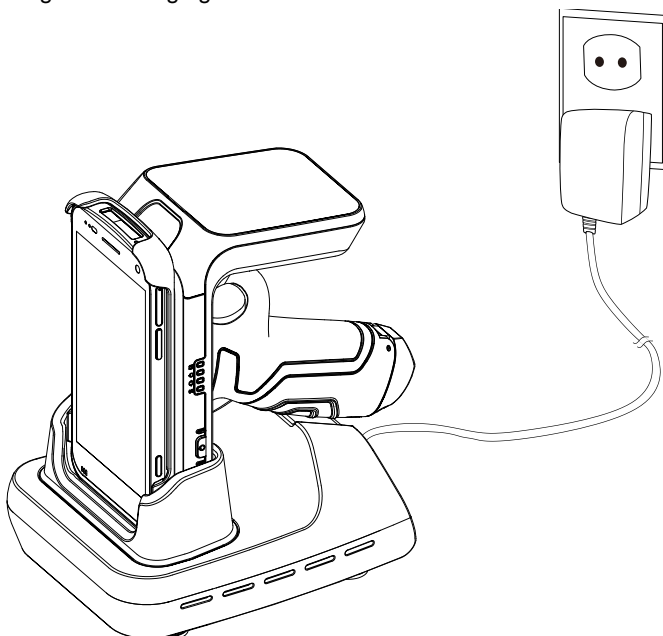

Getting Started

2SC

2SC can charge up to 2 units of PM30 simultaneously. PM30 with PMBooster or protection case mounted can be charged.

1. Assemble the power adapter and power cable.
2. Connect it to the cradle to provide power.
3. Install PM30 from top to bottom.

Make sure the charging LED of the PM30 lights on (Refer to [LED Indicator](#))

Figure 8 Charging PM30 via 2SC

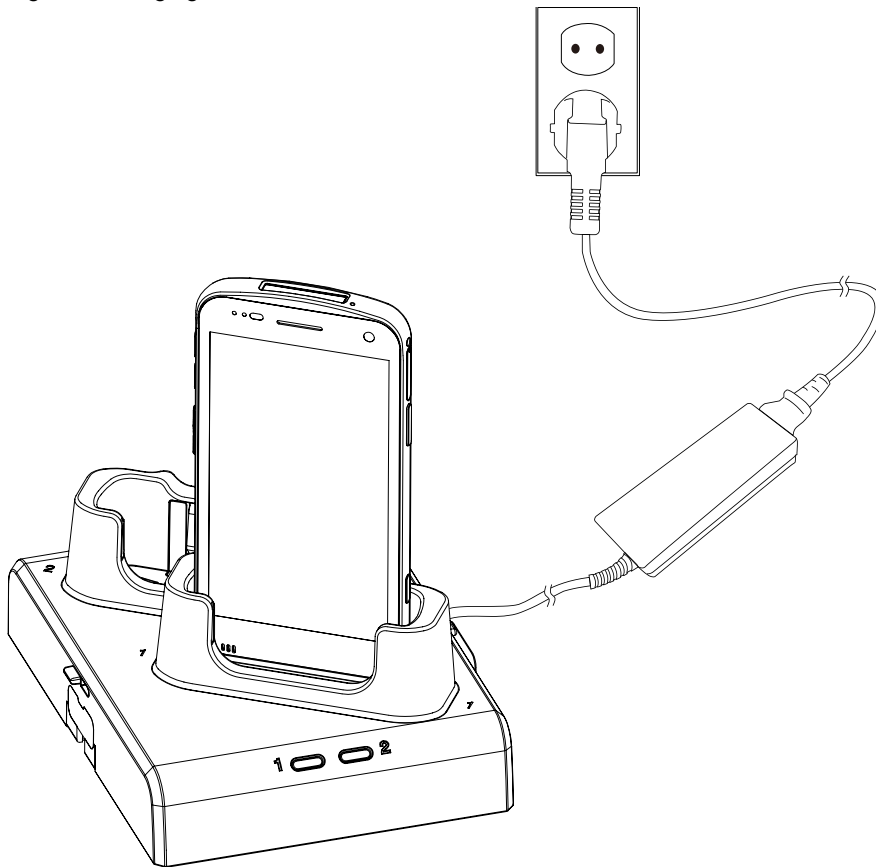

Note: If PM30 with PMBooster mounted is installed into 2SC, PM30 is charged first and PMBooster will be charged after PM30 is fully charged.

Getting Started

Wireless charging pad

PM30 supports wireless charging. Wireless charging pad is sold separately. Before charging, remove all accessories except protective case.

1. Provide power to wireless charging pad.
2. Align the center of PM30 with the center of the charging pad
3. Put PM30 down on the pad

Make sure the charging LED of the PM30 lights on (Refer to [LED Indicator](#))

Figure 9 PM30 Wireless charging

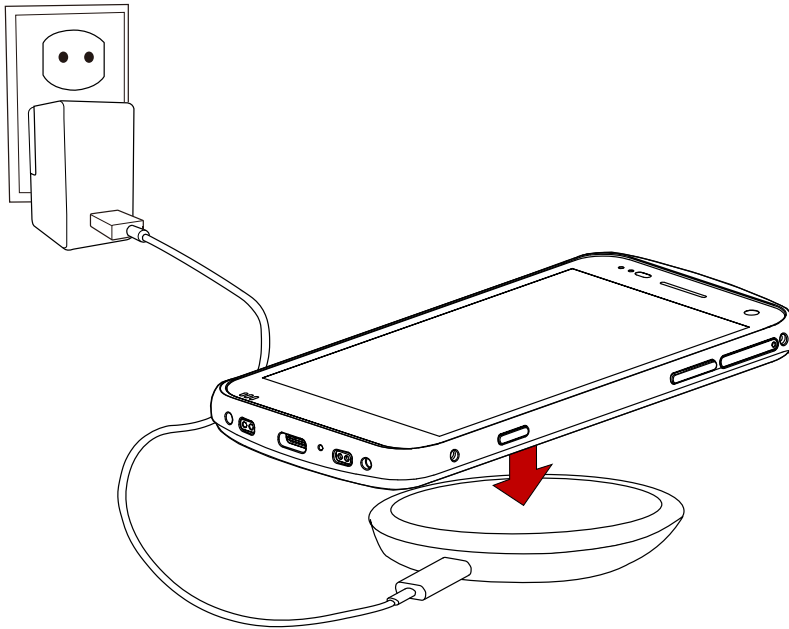

PMBooster (Extended battery case)

PMBooster is a case type accessory which provides extended battery capacity as 3250mAh. Connect PMBooster with PM30 and charge PM30.





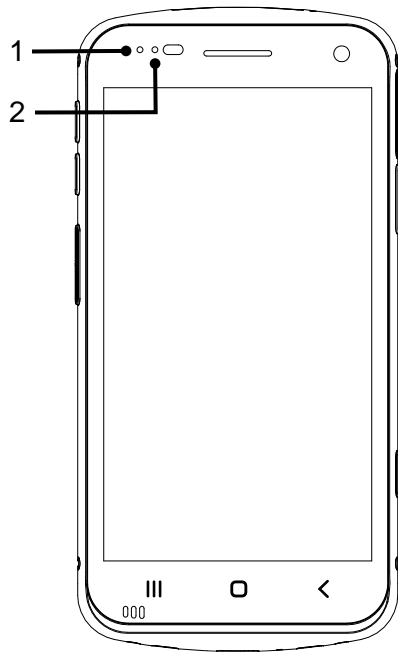

PM30 with PMBooster mounted can be charged using USB Type C cable or 2SC.

Getting Started

LED indicator

Figure 10 LED Indicator



No	Indicator	Status	Indication
1	Power LED	 Solid red	Charging the device (With charger) / Battery is low (Without charger)
		 Blinking red	Battery is critical low
		 Solid green	Device is fully charged
2	Notification LED	 Blinking blue	Notification existing
		 Red flash	Barcode reading failed
		 Blue flash	Barcode reading success

Getting Started

Turn on & off PM30

To turn on the device,

- Press and hold the Power button on the right side of the PM30 until **SMART BEYOND RUGGED** logo displays on the screen.

Figure 11 Power button

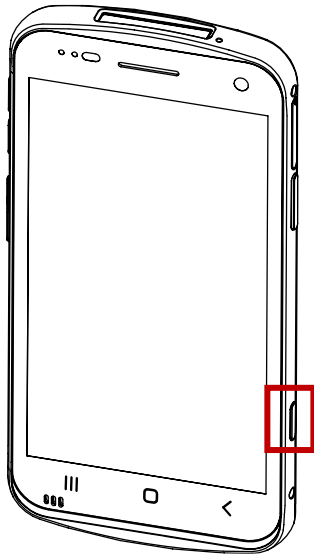

To turn off the device,

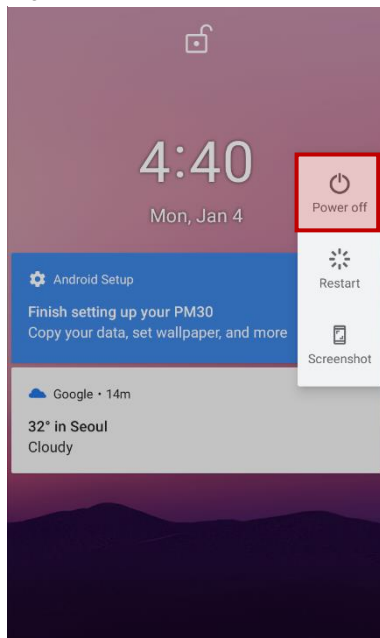

- Press and hold the **Power** button until the power menu is shown when the screen is on. Then, tap **Power off** among the menu.

Figure 12 Power menu



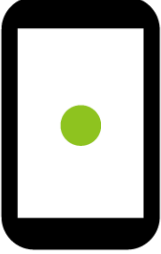

Getting Started

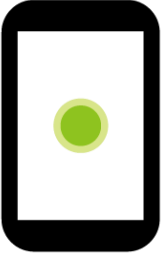
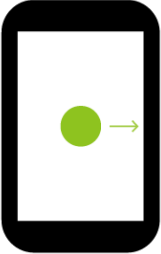
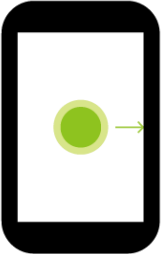
Use a touch screen

Gesture	Description
	<p>Tap One-finger press</p>
	<p>Double tap One-finger press, lift, one-finger press, lift for zoom in action</p>
	<p>Long-press One-finger press, wait, lift for select action</p>
	<p>Drag, Swipe, or Fling One-finger press, move, lift for scroll or tilt action</p>
	<p>Long-press drag One-finger press, wait, move, lift for pick up and move, or select multiple items action</p>

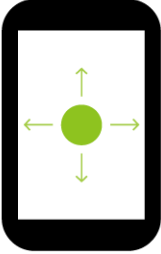
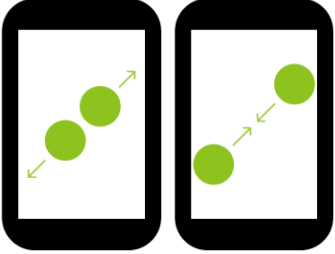
Getting Started

Action	Description
	<p>Scroll Vertical or horizontal swipe in a single direction</p>
	<p>Pinch Open & Close Two-finger press, move outwards and inwards, lift for zoom in / out action</p>
	<p>Rotate When PM30 is turning sideways, screen orientation is changing</p>

Learning the basics

Setup Wizard

When PM30 starts very first time or boot after factory reset, Setup wizard is launched. Following the steps on the screen, set system language, Google account, Wi-Fi connection and copy the data, etc. Some settings can be skipped, but there may be restrictions on the use of system.

Figure 13 Setup wizard - main

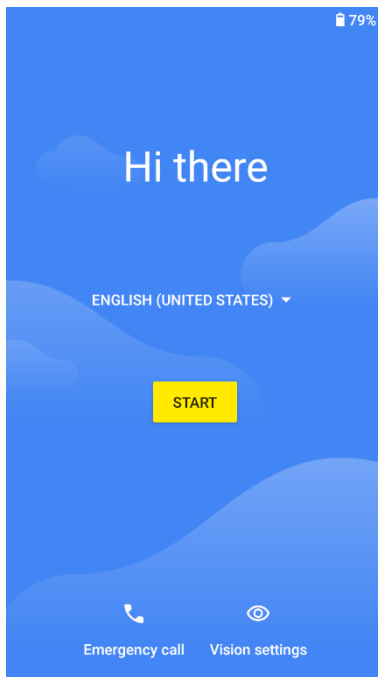
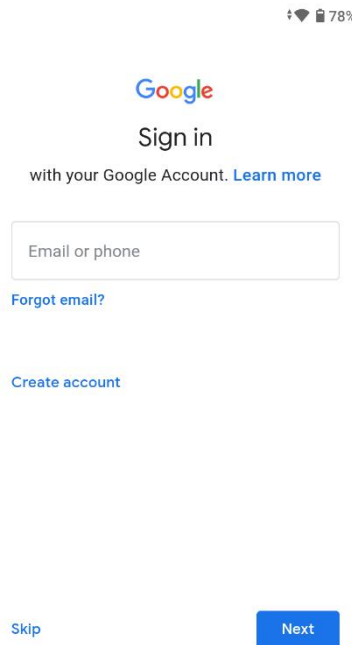

Figure 14 Setup wizard - Google account



Learning the basics

Home Screen

Home screen is a screen displayed after Setup wizard or pressing the Home button.

Figure 15 Home screen



















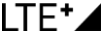











No	Item	Description
1	Status bar	Indicates device status and notification.
2	App	Tap to run the application Long-press to see the application's options
3	Google search	Search an item with Google
4	Favorites tray	Place the frequently used apps
5	App folder	Apps are organized in the folder. Tap to open the App folder

Learning the basics

Status bar













Time, status icons, and notification icons are on the Status bar.

Status icons

Icon	Description	Icon	Description
	LTE connected		Strong signal
	3G connected		Good signal
	EDGE connected		Weak signal
	LTE+ (LTE CA) connected		Connection issue
	VoLTE enabled		Data disabled
	Airplane mode		No data connection
	Data communication		Hotspot enabled
	Connected to a Wi-Fi network		Wi-Fi data communication
	Connected to a Bluetooth device		
	Battery is full		Battery is partially drained
	Battery is low		Battery is very low
	Battery is charging		
	Location service turned on		Vibrate mode
	Speakerphone turned on		Phone mic is mute
	Scanner turned on		Alarm is set

Learning the basics

Notification icons

Icon	Description	Icon	Description
	Missed call		New SMS or MMS message
	New Email		Connected to VPN network
	Upcoming event		Screenshot captured
	SD card removed unexpectedly		Other input method available
	File uploaded		File downloaded
	File copied		OTG device connected
	There are more notifications		

Notification panel

Notification panel displays a list of all notifications. Tap a notification to respond. To open the Notification panel, drag the Status bar down. To close the panel, swipe it up.

Figure 16 Notification panel

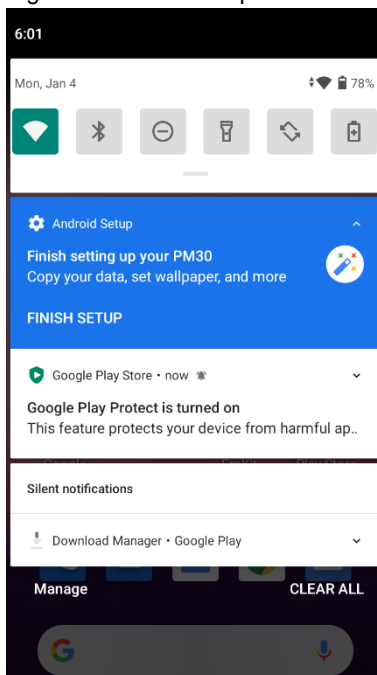

Learning the basics

Quick setting panel

Quick setting panel contains some frequently used settings such as Wi-Fi, Bluetooth, etc. To use the Quick setting panel,

1. Open the Notification panel.
2. Drag down the Notification panel.

Figure 17 Quick setting panel

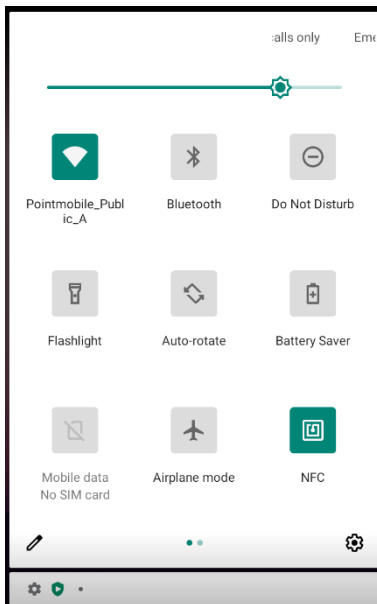

3. Tap a setting icon to enable / disable the setting or long-press an icon to see more detail.

To edit the configuration of Quick settings panel,

1. Tap  on the bottom of the panel.
2. By long-press and dragging the icon, customize the configuration of the panel.

Learning the basics

Apps & Widget

App folder

To create the app folder, long-press an app icon and drag it to another app icon.

Figure 18 Create app folder

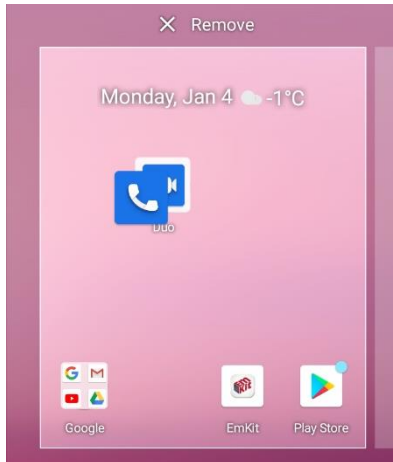

To change the folder name, tap the **Unnamed Folder** and input a new name.

Figure 19 Change app folder name

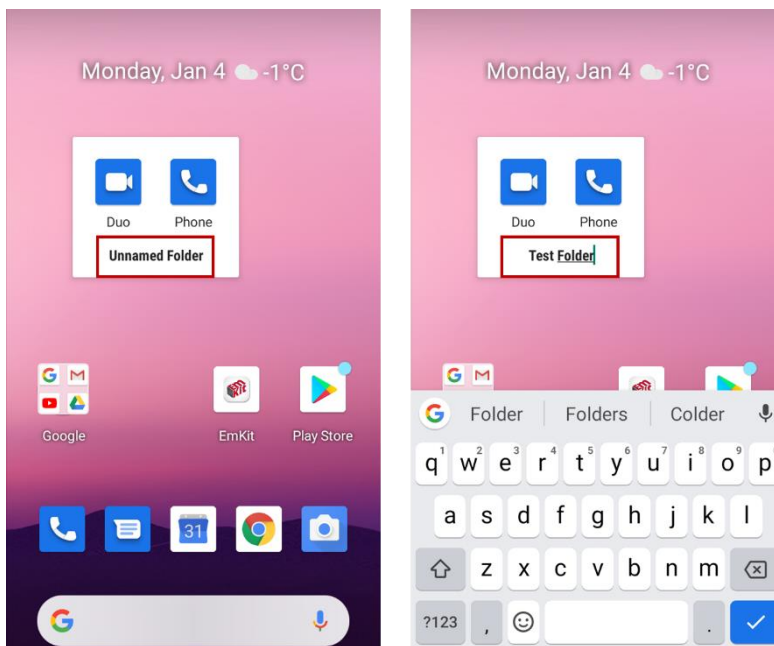

Learning the basics

App drawer

All installed apps are listed alphabetically in App drawer.

- To open the App drawer, swipe up the Home screen.
- To close the App drawer, swipe down the Home screen.

Figure 20 App drawer

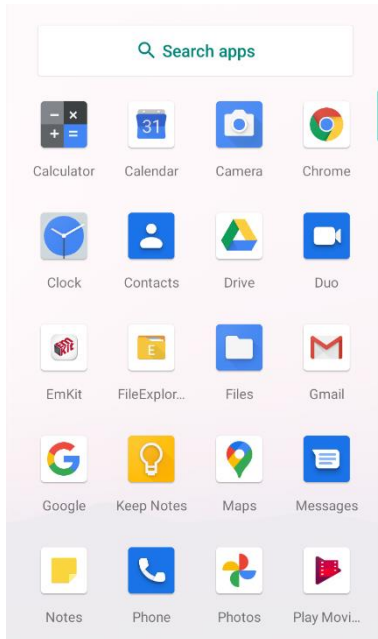

Favorites tray

To organize an app in the Favorites tray,

1. Long-press an app icon from the App drawer. Then, drag it slightly until the Home screen is shown.
2. Place the app icon in the Favorites tray.

Figure 21 Add an app to Favorites tray



Learning the basics

Organize app in Home screen

To organize an app in the Home screen,

1. Long-press an app icon from the App drawer. Then, drag it slightly until the Home screen is shown.
2. Place the app icon where you want.

(To cancel to place the app, drag it to **Cancel** area and release.)

Figure 22 Place app in Home screen

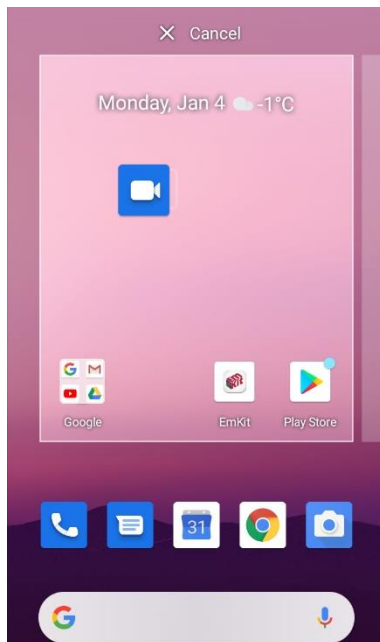

Widget

To add a widget in the Home screen,

1. Long-press the empty space of the Home screen.
2. In three menus, select **Widgets**.

Figure 23 Widget menus

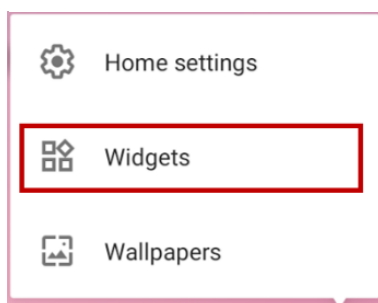

Learning the basics

3. Among the list, tap and hold a widget you want to add.

Figure 24 Widget list

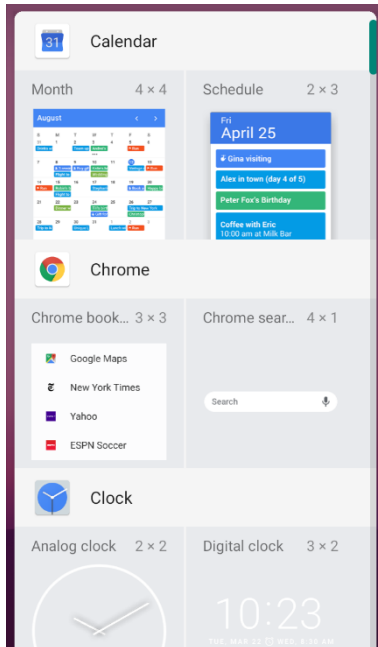

4. Place the widget to the Home screen by dragging.



Note: To remove an app or a widget from the Home screen, long-press and drag it to **Remove** area.

Figure 25 Remove from Home screen

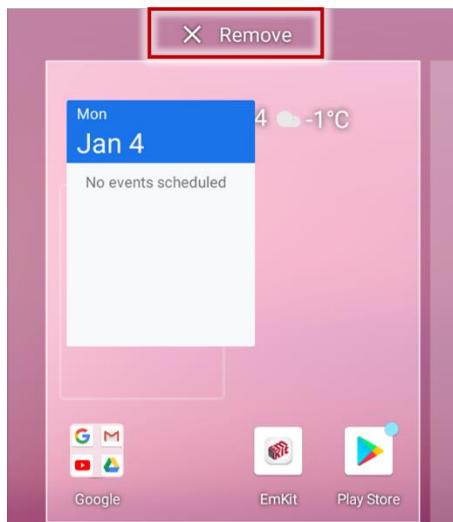

Learning the basics

Recently Used Apps

Touch Recent apps button to see recently used apps list.

Figure 26 Recent app button

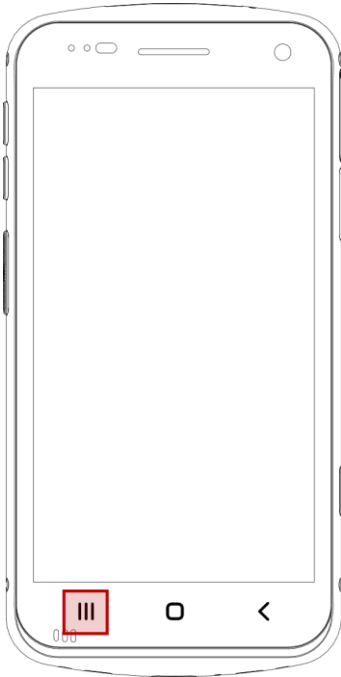

From the list, tap an app to open or completely close the app by swiping it up.

Figure 27 Recently used apps

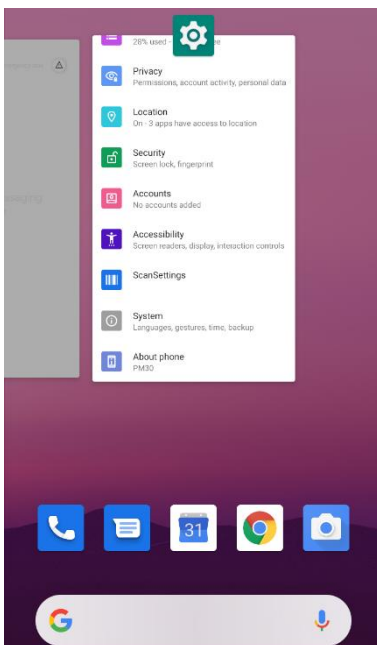

Learning the basics

Call

To make or receive a phone call, SIM card is required. Insert SIM card to PM30 first regarding [Install SIM & SD card](#).

Making a call





1. Tap **Phone**  from Home screen or App drawer.
2. Tap  to open a dialer.
3. Input a phone number.

Figure 28 Dialer





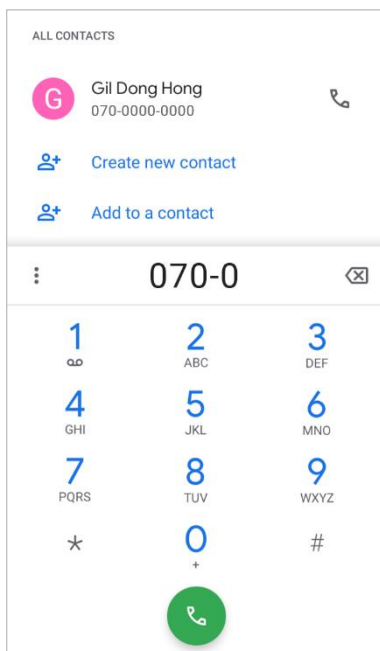

4. Tap  or  next to a searched number to make a call.

Learning the basics

5. Control the Tap  to hang up the phone.

Figure 29 Calling screen



Icon	Function Name	Description
	Mute	Mute microphone
	Keypad	Open the keypad
	Speaker	Speakerphone mode
	Add call	Add another call (Enable when receiver answer the phone)

Learning the basics

Answering a call

Check the caller's name and number and tap **ANSWER** button to answer the phone call. Or tap **DECLINE** button to decline the phone call.

Figure 30 Receiving call

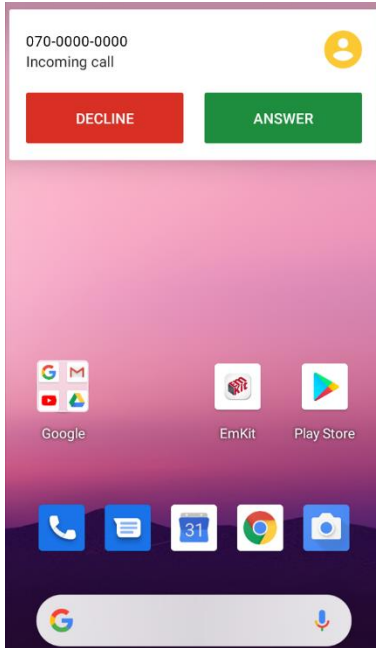

Learning the basics

Contacts

Add a contact

Add a contact via dialer

1. Navigate to dialer through Phone, and enter the number.
2. Tap **Create new contact** or **Add to a contact** to save the number.
3. Input additional information.
4. Tap **Save**.

Add a contact via contacts app

Navigate to Contacts  from App drawer and tap  to add a new contact.

Figure 31 Add new contact via Contacts

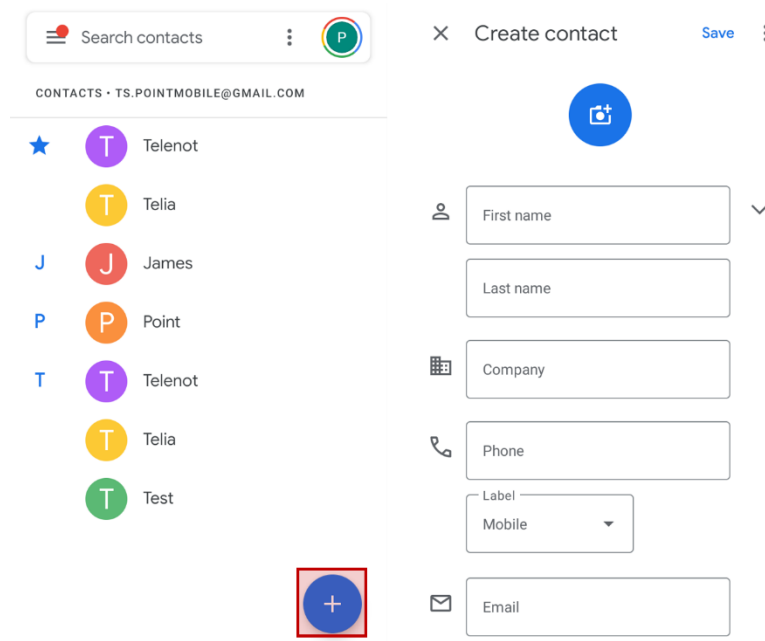

Enter the contact details and tap **Save**.

Learning the basics

Contact detail

Select a contact from the list to find more detail information.

Figure 32 Contact detail

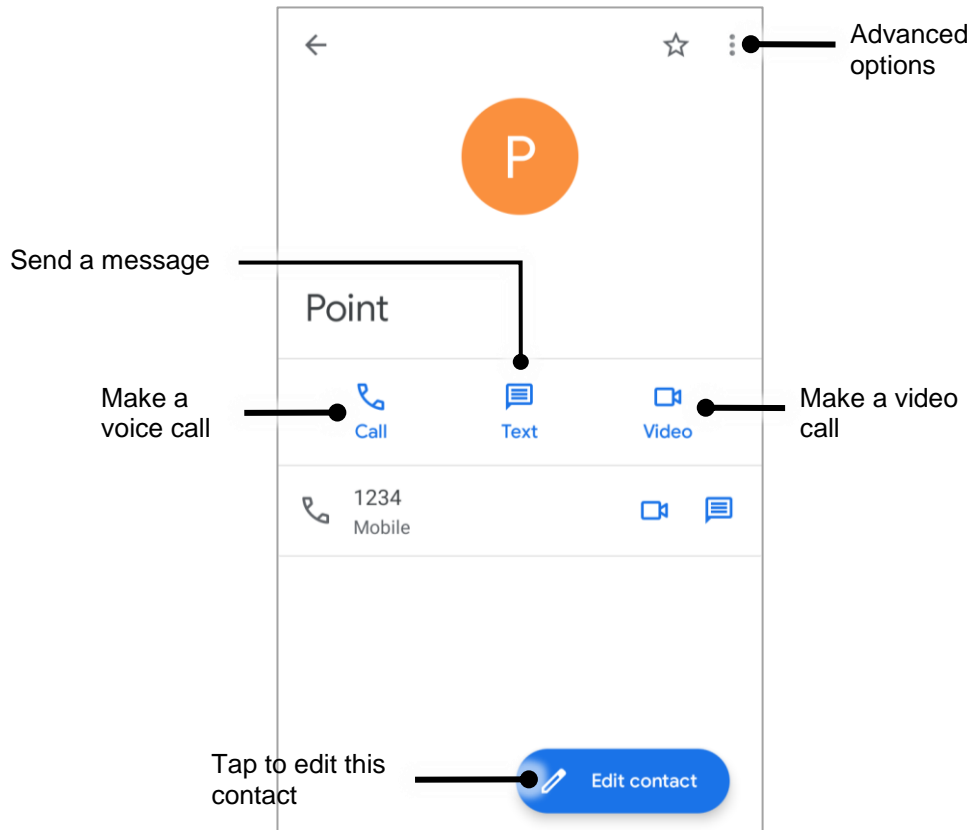



Tap  to open advanced options such as delete, share, block, etc.

Figure 33 Contact advanced options

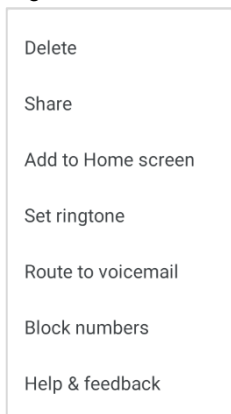

Learning the basics

Message

Send a message or find the received message through Message application .



1. Launch Message  from App drawer.
2. Tap **Start Chat** and type the receiver's name or phone number.

Figure 34 Message list

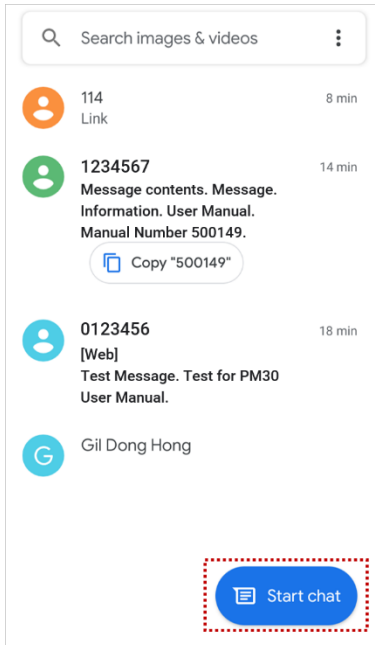

3. Input a message.
4. Tap  icon to send.

Learning the basics

MTP Connection with PC

To transfer the files with a PC, connect the device to the PC via USB cable first.

1. Drag down Status bar and tap **Android System** notification to change USB preference option

Figure 35 USB connection notification

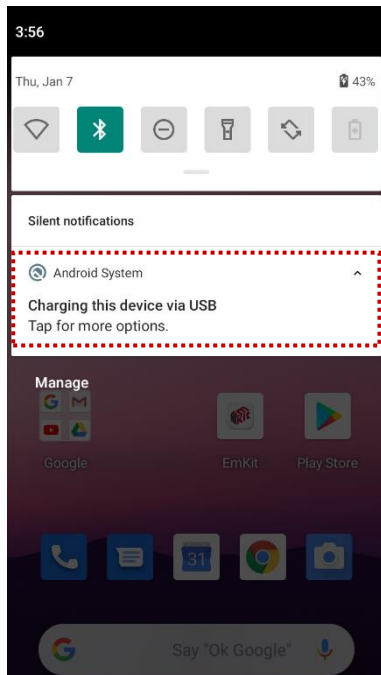

2. Change the option to **File Transfer** from **No data transfer**.

Figure 36 USB Preferences setting

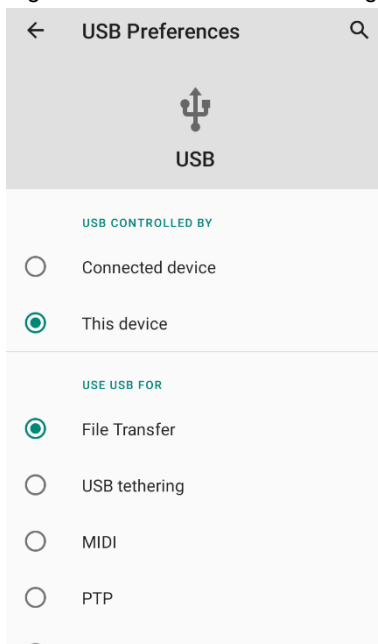

Learning the basics

3. Now PC can recognize the connected device. Find PM30 device from file explorer of the PC.

Figure 37 File explorer on PC



Manage the Files

Figure 38 FileExplorer main screen

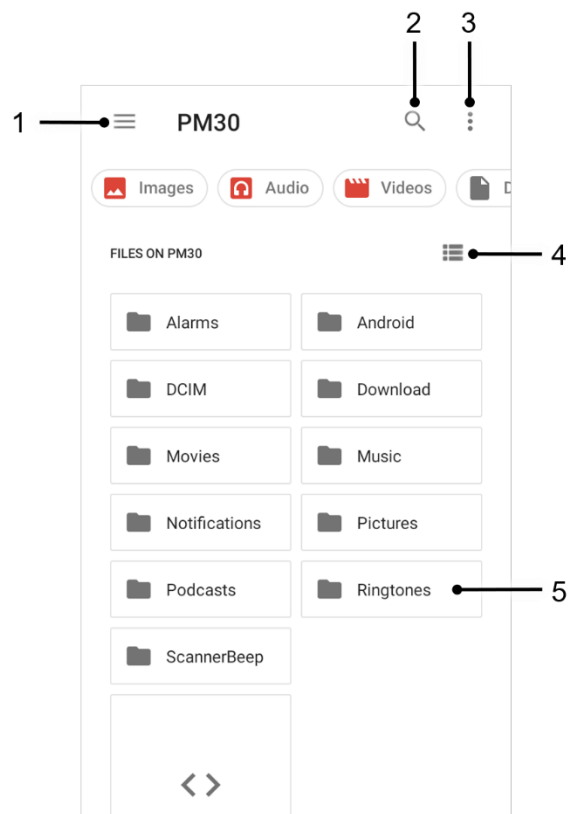

No	Description
1	Select media file type or storage
2	Search a file
3	Open the advanced option – Create a new window or folder, Select all files and folders, etc.
4	Change the view of file list
5	Tap a file or folder to open. Or long-press a file or folder to select

Learning the basics

Long-press a file (folder) or tap the icon which is located beside of file name to select the file (folder).

Figure 39 FileExplorer screen when file selected

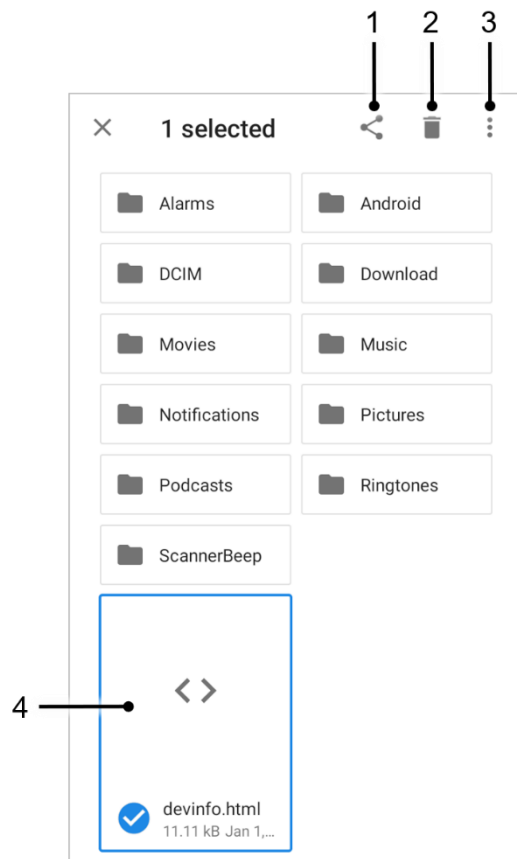

No	Description
1	Share the file via Bluetooth / Gmail / Google Drive, etc. Sharing is possible only with files
2	Delete the files or folders
3	Open the advanced option <ul style="list-style-type: none"> • Open with: Select which app to open the file • Sort by...: Sort the list by file name, size, type, etc. • Select all: Select all files and folders • Copy / Move to: Copy or move the file to a new location • Compress: Create Zip file with the selected files or folders • Rename: Rename the file or folder • Get info: Display the file information
4	Selected file or folder is highlighted

Learning the basics

Lock the Screen

Protect the device from unauthorized personnel by setting up the screen lock.



1. Navigate to **Settings**  > **Security** .
2. Tap **Screen lock**.

Figure 40 Screen lock



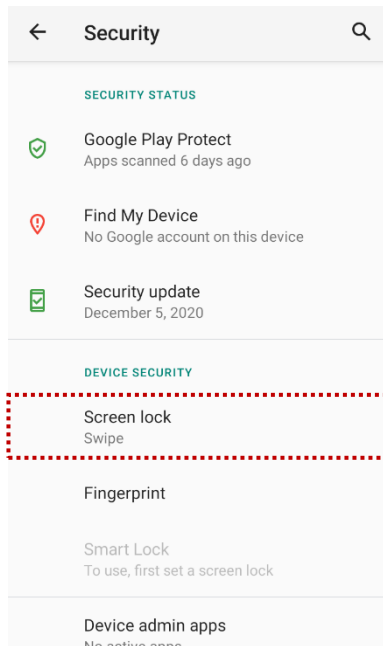

3. Choose a screen lock method.
 - None: Screen unlocks immediately
 - Swipe: Swipe the lock screen to unlock (Default)
 - Pattern: Draw a pattern to unlock
 - PIN: Input a PIN to unlock (At least 4 digits)
 - Password: Input a password to unlock (At least 4 characters)

Learning the basics

Fingerprint lock

PM30 supports fingerprint lock. Enroll the fingerprint comfortable to use for unlocking the screen.

1. Navigate to **Settings**  > **Security** .
2. Tap **Fingerprint**.



Note: Backup Screen Lock Method

Fingerprint lock cannot be used alone. A backup screen lock method is required. Choose a method between pattern, PIN, password. (Swipe method is not allowed.)

Figure 41 Backup screen lock

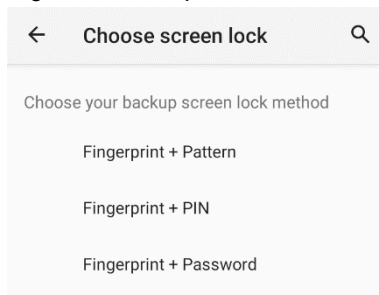

3. (After setting the backup screen lock method) tap **Next**.
4. To enroll the fingerprint, follow the instructions on the screen; touch and lift the finger on the fingerprint sensor several times.

Figure 42 Fingerprint sensor

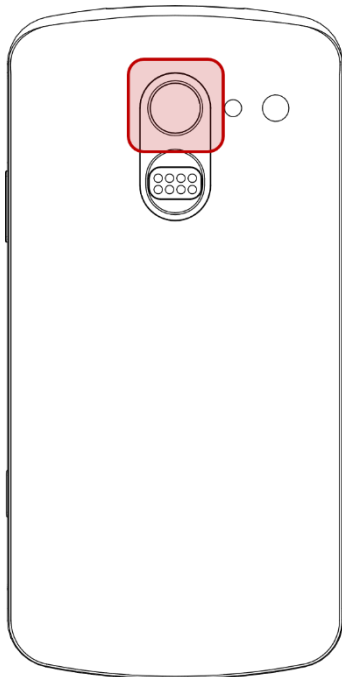
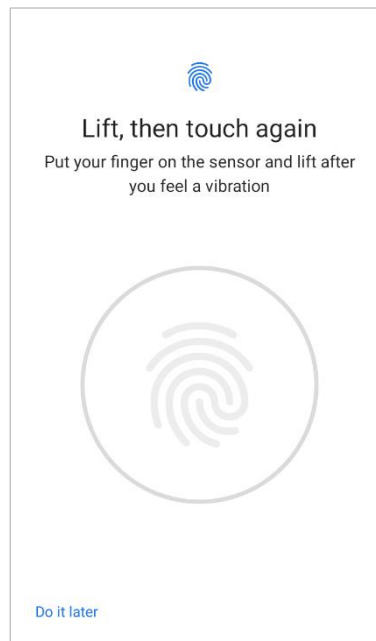

Figure 43 Enroll fingerprint



Learning the basics

5. When the fingerprint is enrolled properly, **Fingerprint added** screen is displayed.
6. Tap **Done** to finish adding fingerprint
or tap **Add another** to add another fingerprint (Up to 5 fingerprints can be added).

Figure 44 Fingerprint added screen

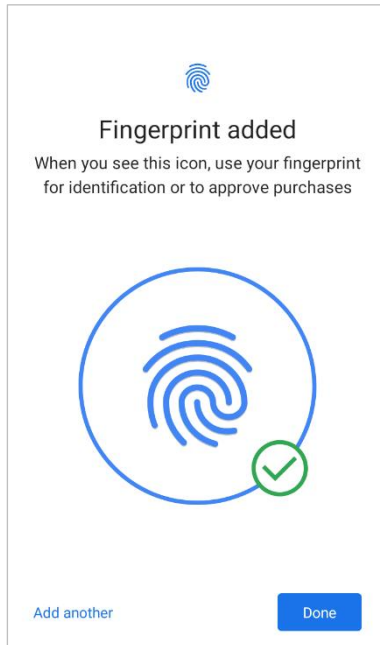

7. Find the list of added fingerprints.

Delete a fingerprint by tapping trash can icon  or rename by tapping the fingerprint name.

Figure 45 Fingerprint list

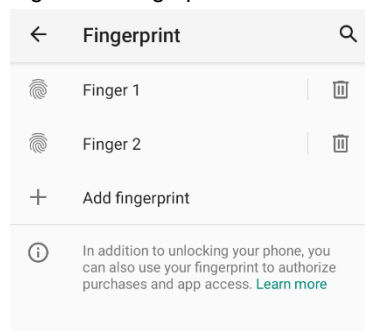

8. To unlock the screen, touch the fingerprint sensor with the finger enrolled.
(Fingerprint unlock works when the screen is turned off as well as the lock screen.)

Learning the basics

Use the Buttons

Screen capture

To take a screenshot, press and hold power button and volume down button simultaneously. The screenshot image will be saved to **Pictures > Screenshots** folder in the internal storage.

Program buttons

All buttons on the PM30 except power button can be optimized as you want. To map the button to other functions from default,

1. Navigate to **EmKit**  > **Program Buttons** 
2. Select a button from the list

Figure 46 Program buttons - button list

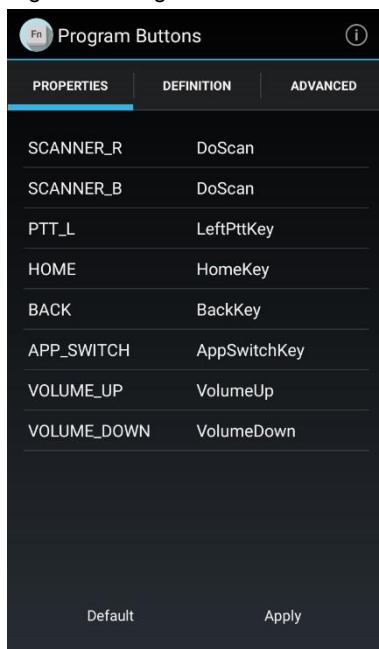

Refer to the figure indicating button code name in the next page.

Learning the basics

Figure 47 Program buttons - PM30 button code name

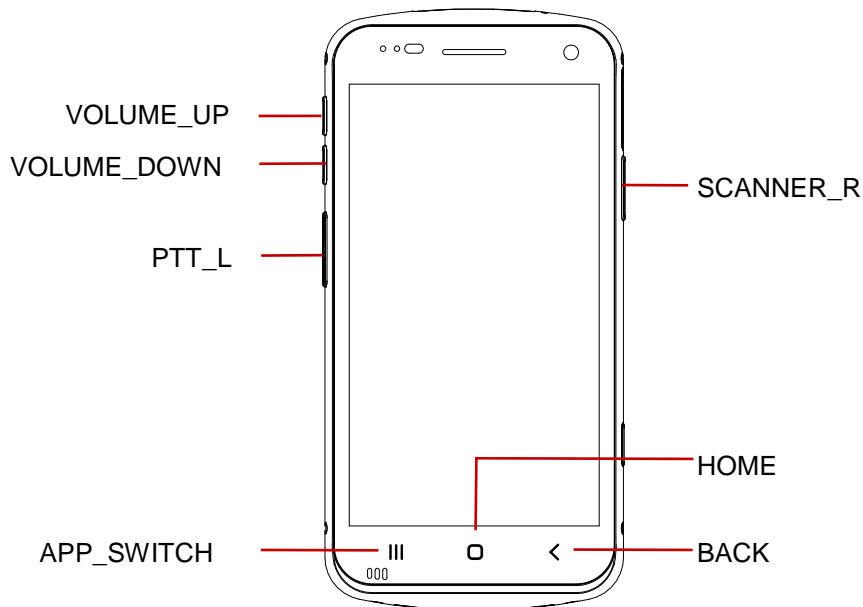

i **Note:** *SCANNER_B is the trigger button on the sled accessory (gun handle or RF300).*

3. Choose one function you want to remap

Figure 48 Program buttons - function list

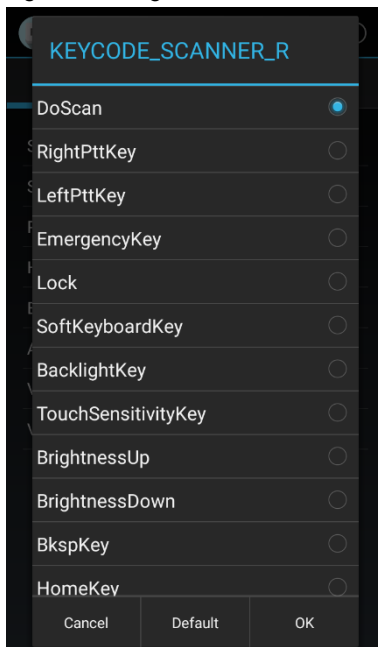



4. Tap **OK**

5. After changing all key mapping, tap **Apply** to save the changes

Learning the basics

Settings

There are two ways to go to **Settings**:

- Open the App drawer and tap **Settings** 
- Open the Quick setting panel and tap gear icon 

Adjust display brightness

To adjust the display brightness level,



- Open Quick setting panel and adjust display brightness bar
- Go to **Settings**  > **Display**  > **Brightness level**

Figure 49 Normal brightness level



Figure 50 High brightness level (higher than 80%)



Caution: Using high brightness levels for long periods may cause eye strain and increase battery consumption.

Adjust sound



To adjust sound volume, go to **Settings**  > **Sound**  and control the Media, Call, Ring, Alarm volume bars.

Figure 51 Volume bars



Caution: Using high volume levels for long periods may cause ear strain and increase battery consumption.

Learning the basics

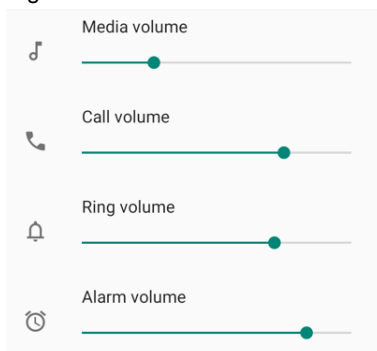
Adjust font size

If the font size of the screen is too small or too large, adjust the font size.



1. Go to **Settings**  > **Display** 
2. Tap **Advanced**
3. Tap **Font size**
4. Referring to the **Preview**, set the font size

Figure 52 Set font size



Camera

PM30 has 2 cameras on the front side and the rear side. To use the camera, open App drawer and tap Camera application .

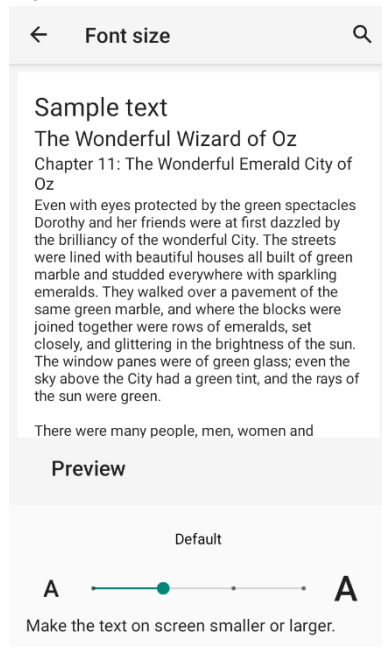
Figure 53 is a main screen of Camera application, and Figure 54 is a screen that is displayed when you swipe the screen to right.

Figure 53 Camera main screen

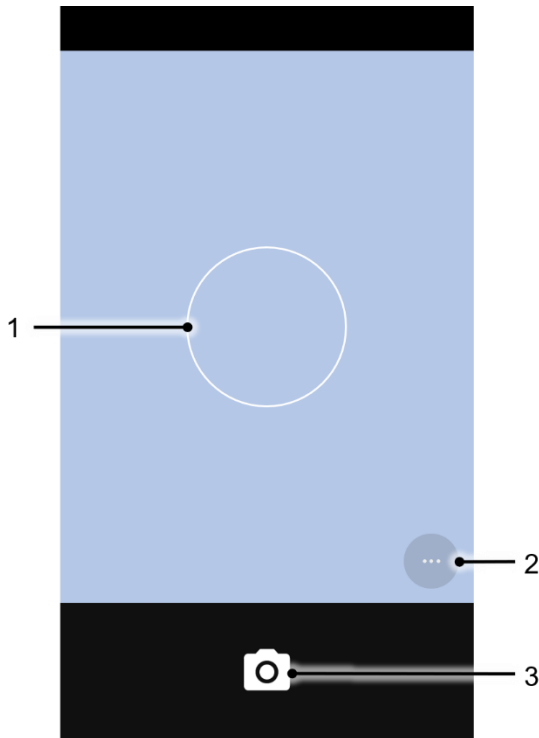
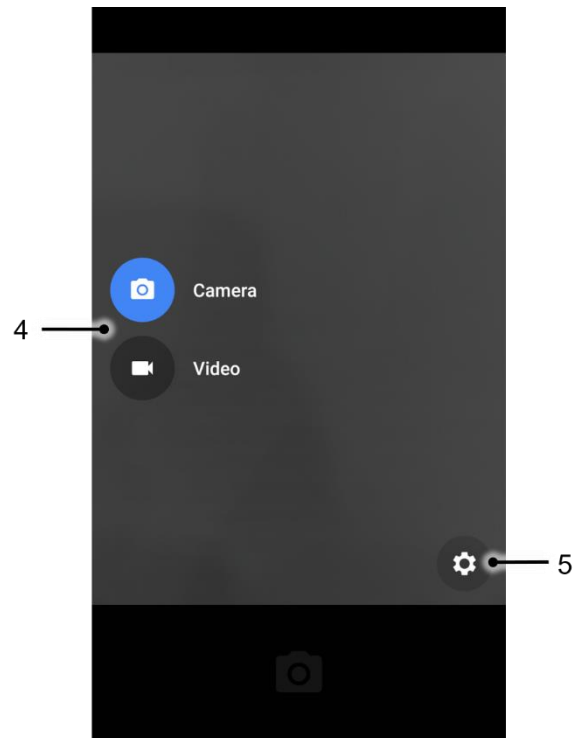





Figure 54 Camera mode change/setting screen



No	Name	Description
1	Focus zone	You can change the focusing area by touching the other area
2	Advanced camera option	 : Set timer  : Display the grid on the screen  : Activate or Deactivate HDR  : Set flash mode (Activate / Deactivate / Auto mode)
3	Shutter button	Take a picture or recode a video
4	Mode change button	Change the Camera or Video mode
5	Advanced camera setting	Set resolution & quality of picture Enable / Disable saving location and manual exposure

Scanner

Scanner is placed on the top of the PM30. Optimize the scanner settings for working environment and improve the efficiency.

Figure 55 PM30 scanner location

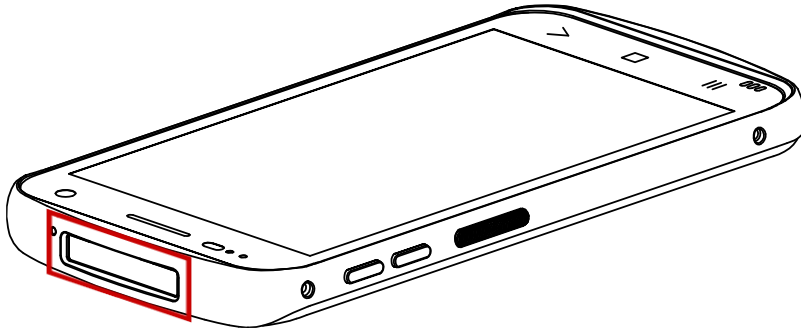

Turn on / off the Scanner

The scanner is turned off by default. To turn on the scanner, follow the steps.





1. Go to **EmKit**  or **Settings**  and tap **ScanSettings**.
2. Tap toggle button to turn on/off the barcode scanner.

Figure 56 Turn on scanner

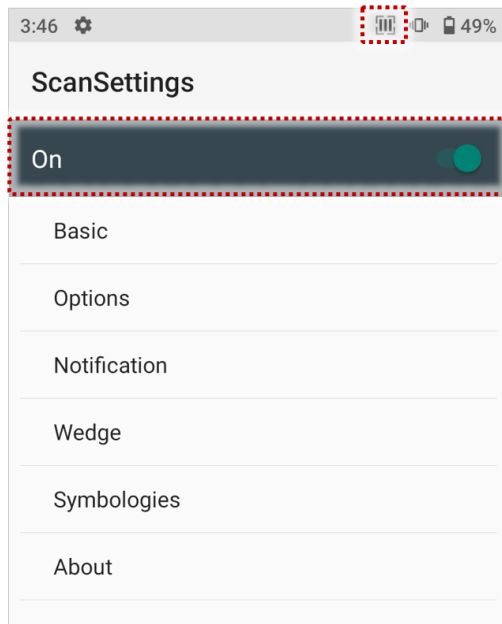

3. Check if the scanner icon () is placed on Status bar.

Scanner

ScanSettings

When the scanner is turned on, scanner setting menus will be displayed. **ScanSettings** consists of

- Basic
- Options
- Notification
- Wedge
- Symbologies
- About

Basic

Control the scanning options and wedge mode options.

1. Scanning

- Change the scanner's trigger timeout and set Auto scan & Continuous scan.
- Enable or disable the TouchScan, which is a software scanner button. Place a scan icon in any position and tap the icon to read a barcode.

Figure 57 ScanSettings - Basic

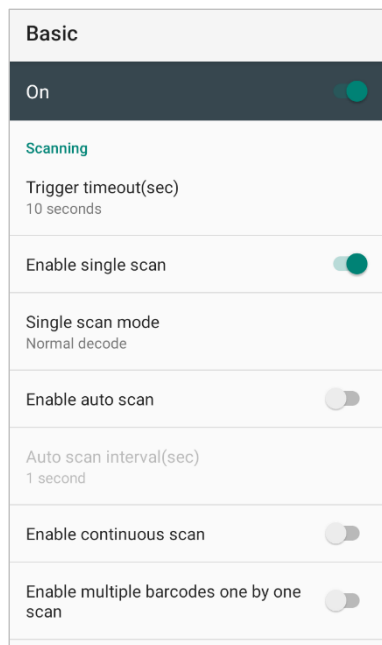
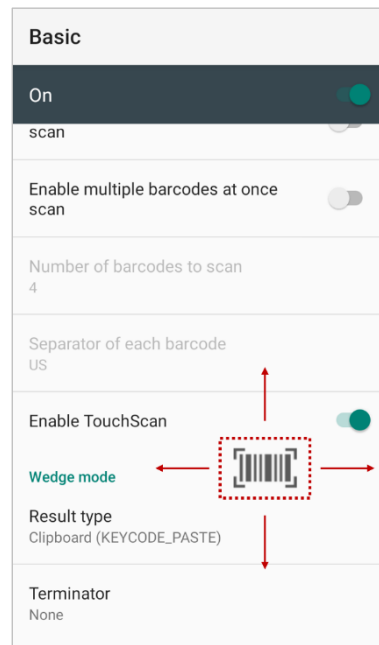

Figure 58 ScanSettings - TouchScan



Scanner

2. Wedge mode

- Change the result type of decoded data among the below list.
- User Message
- Keyboard Event
- Clipboard (KEYCODE_PASTE)
- Clipboard (Ctrl + V)
- Intent Broadcast
- Custom Intent
- Set Terminator as,
- None
- Space
- Tab
- LF
- Tap & LF

Options

- Enable / Disable the center window, Aimer, Illumination.
- Set Decode mode & Power save mode.

Figure 59 ScanSettings - Options

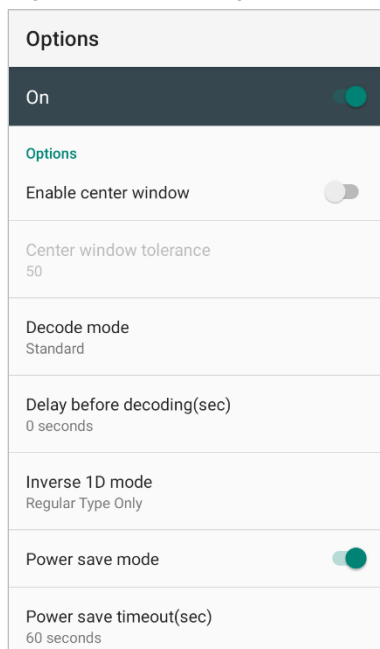

Scanner

Notification

Control the beep sound, LED and vibration option.

Figure 60 ScanSettings - Notification

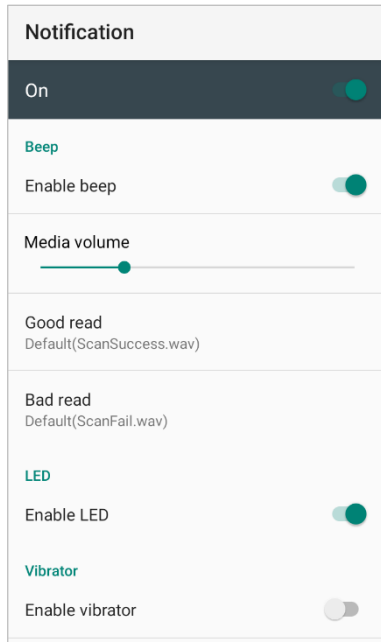

Scanner

Wedge

Set below items in Wedge settings

- Barcode ID
- Aim ID
- Group separator
- Prefix
- Suffix
- Character set
- Extended Wedge

Figure 61 ScanSettings - Wedge

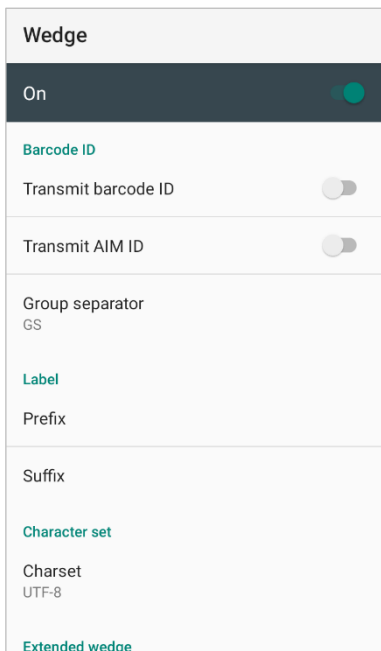

Scanner

Extended wedge

PM30 supports Extended wedge that allows to edit the decoded data. Tap **Enable extended wedge** toggle switch and then set a rule in **Configuration extended wedge**.

Figure 62 ScanSettings - Extended wedge

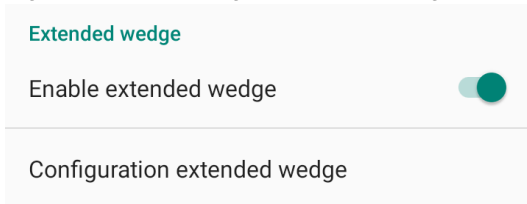

For example, make a rule that add a string “*Point Mobile*” at the start of decoded data whenever decoding CODE128.

1. Tap **Style** (1) and select **Condition** (2).

Figure 63 Extended wedge example_1

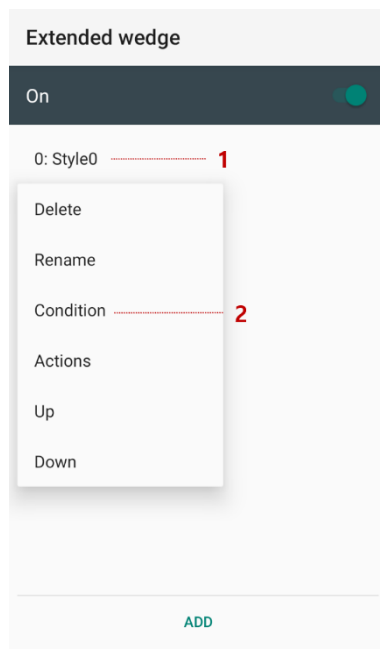

Scanner

2. Tap **Symbologies** and select **CODE128** among the symbologies.

Figure 64 Extended wedge example_2

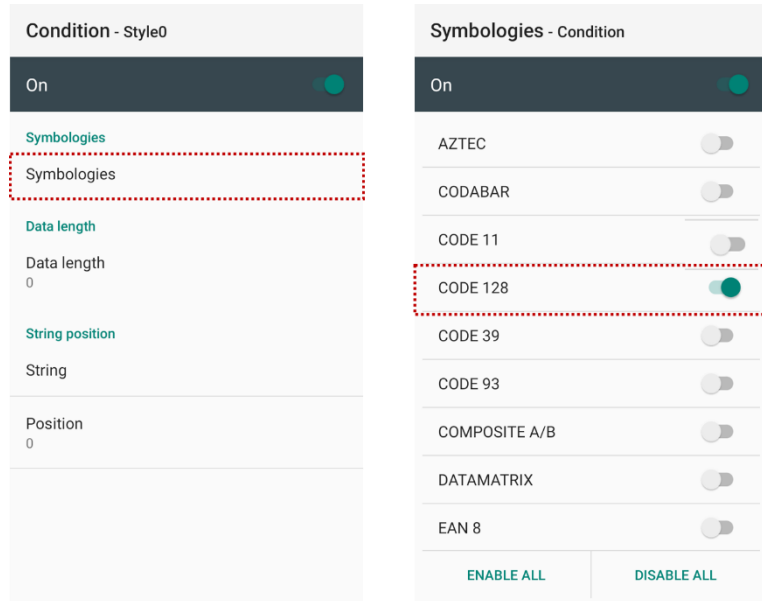

3. Tap **Style (1)** and select **Actions (2)**.

Figure 65 Extended wedge example_3

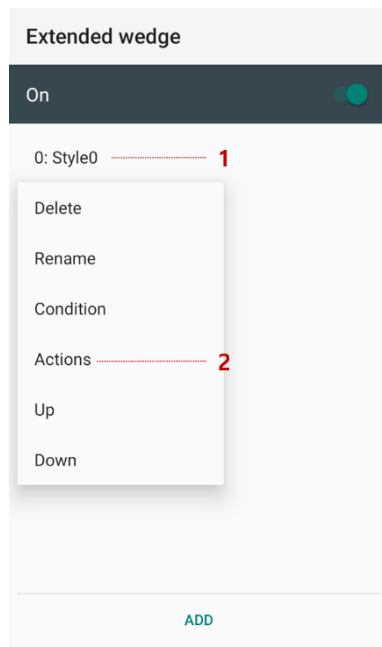

Scanner

4. Tap **ADD** and select **Move to start** to point the start of the decoded data.

Figure 66 Extended wedge example_4

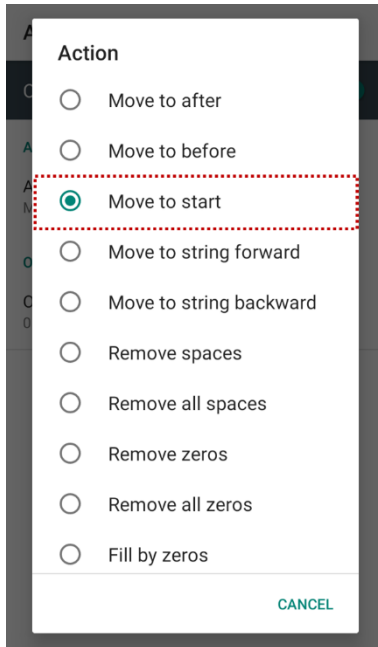

5. Add another action of which action type is Send string. Set value as "*Point Mobile*".

Figure 67 Extended wedge example_5

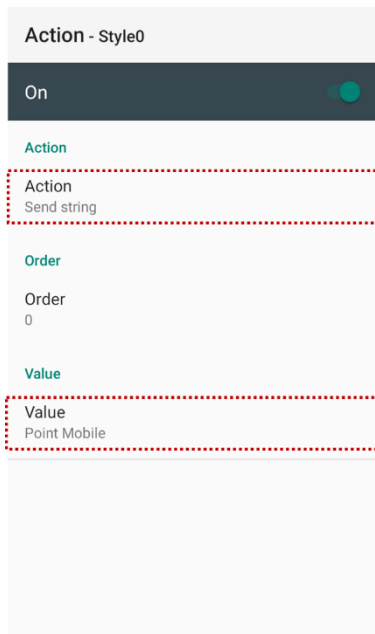

Scanner

6. "Point Mobile" string will be added to decoded CODE128 data.

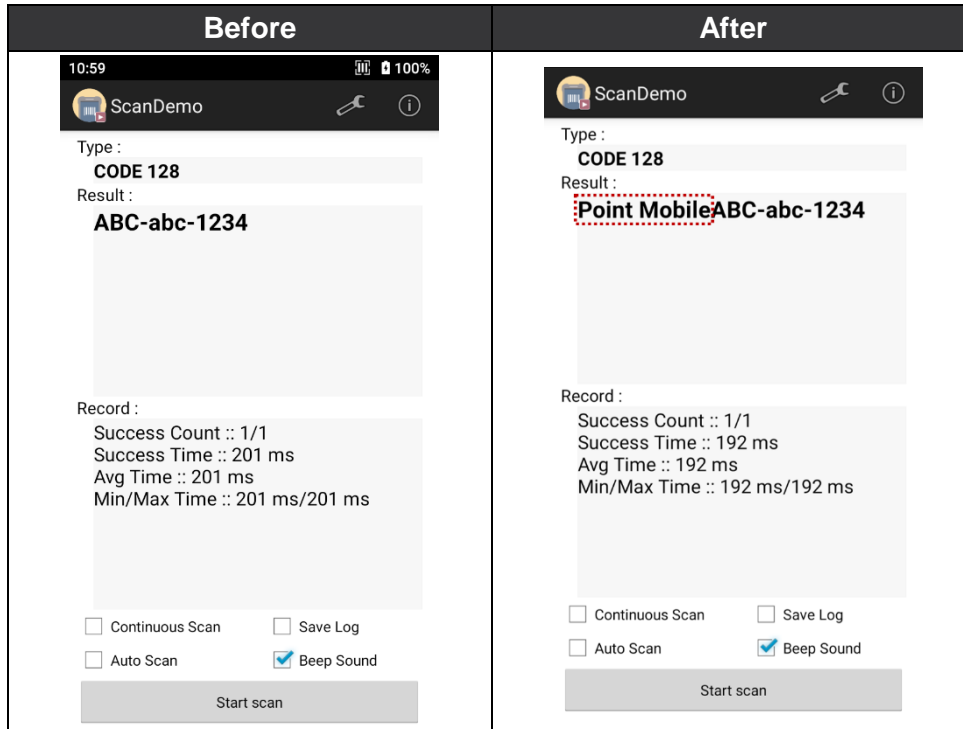

Scanner

Symbologies

Enable or disable the specific symbology or set detail options. By tapping each symbology name to access detail options.

Figure 68 ScanSettings - Symbologies

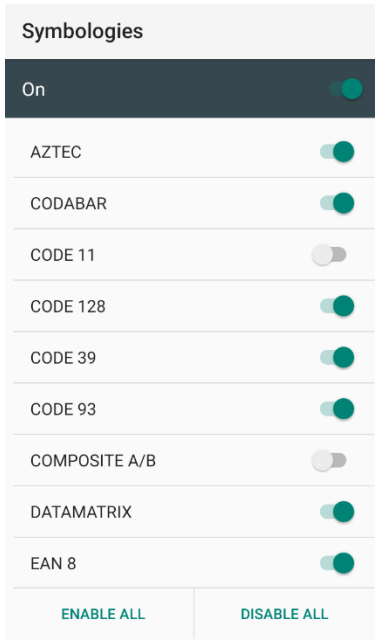

About

Find the scanner information or restore the scanner settings to default.

Figure 69 ScanSettings - About

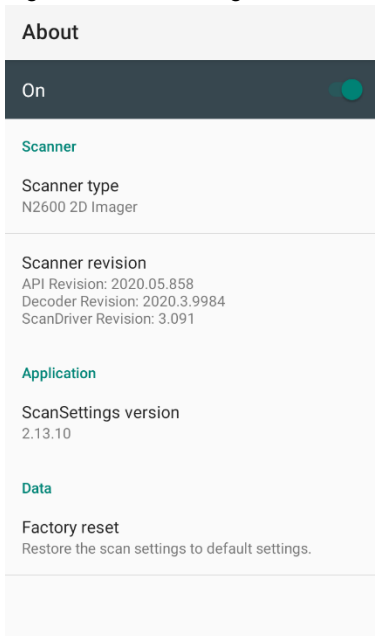

Scanner

Scan a Barcode

Keep the distance as aim the barcode while pressing the scan button on the left side of the PM30. If another button is set as scan trigger using Program buttons (Refer to [Use the Buttons – Program buttons](#)), it can trigger the scan action, too.

Figure 70 PM30 default scan button

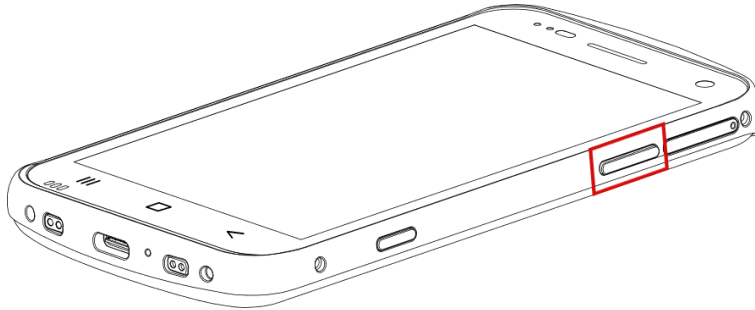

Ideal barcode reading



Place the barcode within the green dot aimer.



Even if the green dot aimer is covering only part of barcode, PM30 can read the barcode if it is aiming enough area.

Bad barcode reading



Keep the distance that the green dot aimer can cover the barcode enough.

Scanner

ScanDemo

Using Scan Demo app, demonstrate the scanning feature.



1. Execute **EmKit**  > **ScanDemo** .
2. Scan a barcode by pressing the scan button on the device or tapping **Start scan** button on the screen.
3. Find scan result

Figure 71 ScanDemo



Wireless

Mobile Network (LTE SKU Only)

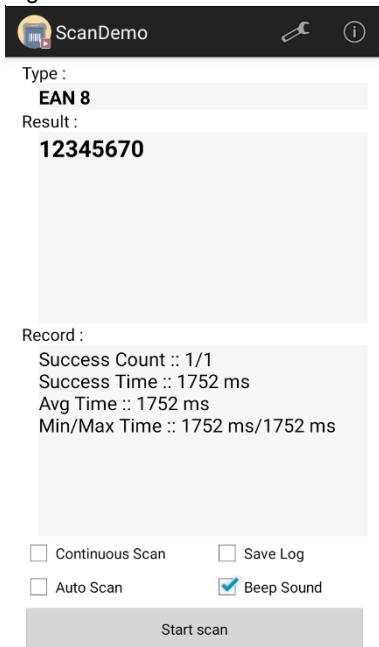
PM30 LTE SKU (PM30G6K03DHE0F) supports mobile network. To connect mobile network, SIM card is required. Insert SIM card into PM30 first referring [Install SIM & SD card](#).

After inserting the SIM card, reboot the device. When network is connected, a network icon will be appeared on the status bar.

Figure 72 Mobile network icon

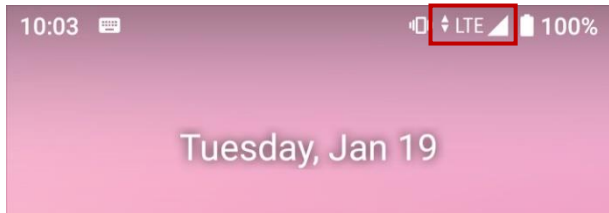



Find network information and adjust the network settings in **Settings**  > **Network & internet** . This setting menu can also be accessed by long-press the Mobile data icon in Quick setting panel.

Figure 73 Mobile network setting

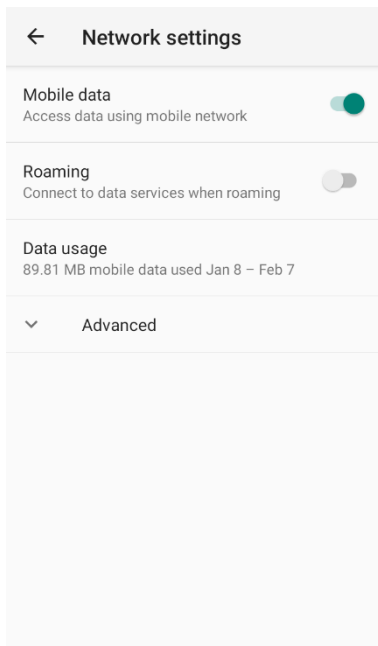
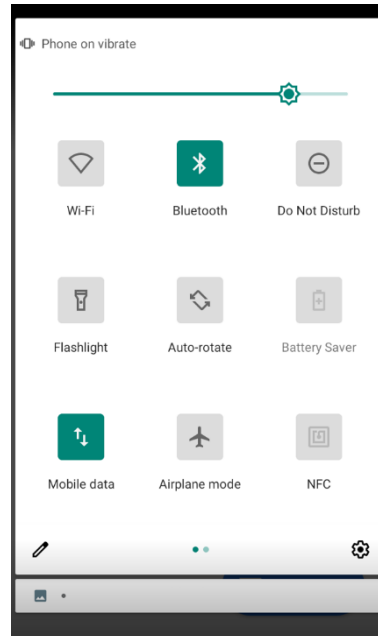

Figure 74 Quick setting panel - mobile network



Wireless

Wi-Fi

To turn on and connect a Wi-Fi,



1. Go to **Settings**  > **Network & internet**  > **Wi-Fi**.
2. Tap toggle button to enable Wi-Fi.
3. Device searches for nearby Wi-Fi signals and lists them in order of signal strength.
4. Select a Wi-Fi SSID to connect.
5. The message **Connected** under the SSID means the device complete to connect to the Wi-Fi.

Figure 75 Wi-Fi connected



Note: There are Open Wi-Fi network and Secured Wi-Fi network. You can tell those apart by lock icon (🔒) in the nearby Wi-Fi list.

To connect the secured Wi-Fi network, you need to enter the password.

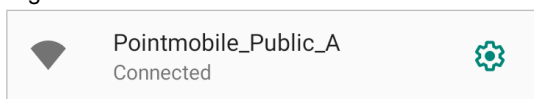
Figure 76 Open Wi-Fi Network

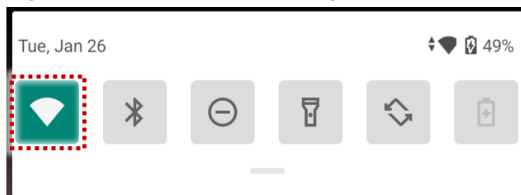

Figure 77 Secured Wi-Fi Network



If there is a saved Wi-Fi network, simply turn on the Wi-Fi through the Quick setting panel. The saved network will be connected automatically.

Figure 78 Wi-Fi in Quick setting panel



Wireless

Bluetooth

Turn on / off

Bluetooth is turned off as default. There are two ways to turn on the Bluetooth,

- Open quick setting panel and enable Bluetooth 

Figure 79 Bluetooth in Quick setting panel



- Go to **Settings**  > **Connected devices**  > **Pair new device**

Pair and Connect

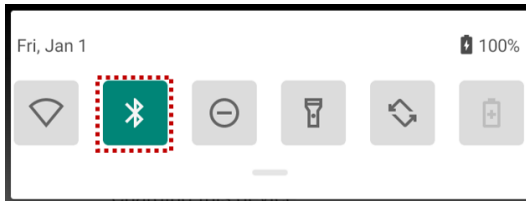
Bluetooth is turned off as default. To turn on the Bluetooth and connect with a new device,



1. Go to **Settings**  > **Connected devices** .
2. Tap **Pair new device**.
(Bluetooth will be turned on automatically)
3. Select the device you want to pair among **Available devices** list.

Figure 80 Bluetooth available devices



4. Follow instructions on the screen (Pairing code or pairing confirmation dialog) and tap **PAIR**.

Wireless

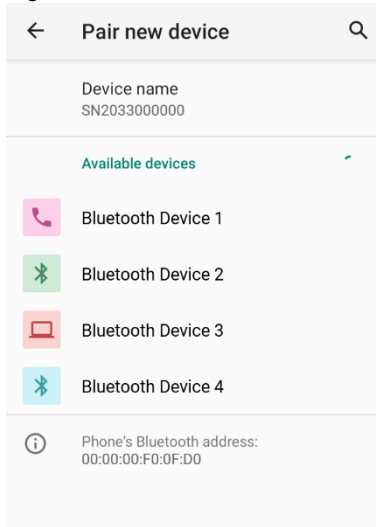
5. When the connection is succeeded, the connected device name is listed in **CURRENTLY CONNECTED**

Figure 81 Bluetooth currently connected

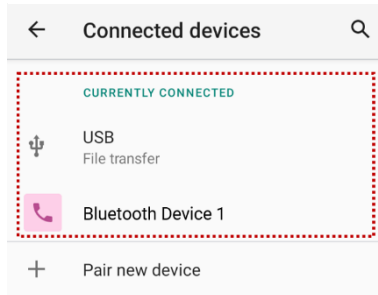

To connect a device previously connected, select the device name from the **PREVIOUSLY CONNECTED DEVICES** list.

Figure 82 Previously connected devices

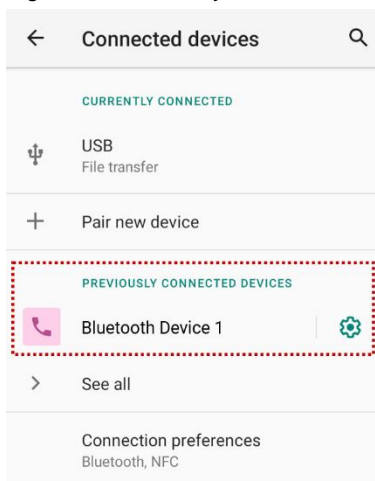

Unpair and Disconnect

To unpair the device, select the name of the device you want to unpair from **CURRENTLY CONNECTED** list and tap **FORGET** .

Or tap **DISCONNECT**  to disconnect only and not unpair.

Figure 83 Forget device

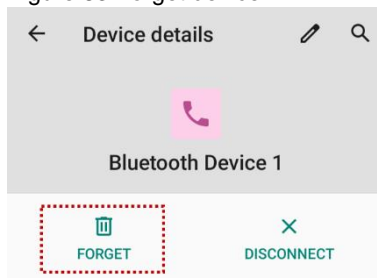

Wireless

Change the Bluetooth device details

Select a device name from **CURRENTLY CONNECTED** or tap  icon next to the device name from **PREVIOUSLY CONNECTED DEVICES** list.

If no devices are listed under the **PREVIOUSLY CONNECTED DEVICES**, tap **See all**.

Figure 84 Bluetooth device detail

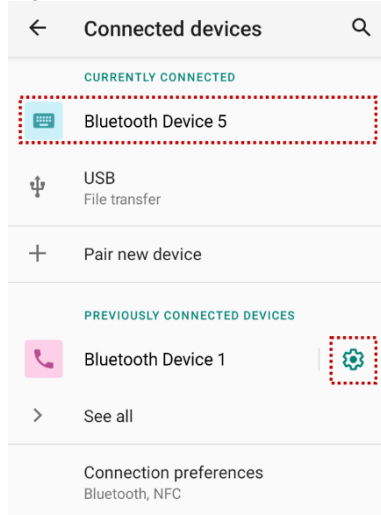

- To change the device's name, tap  on the top of the screen
- Turn other settings on or off (Available on some devices)

Wireless

NFC (Near Field Communication)

NFC is enabled by default. But if NFC does not work, make sure the NFC  is enabled from the Quick setting panel.

Figure 85 NFC in Quick setting panel



PM30 has an NFC antenna on the rear side. Check NFC antenna location and bring close the NFC tag to antenna as below.

Figure 86 NFC antenna location

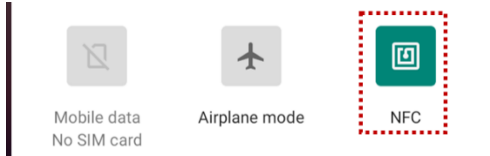
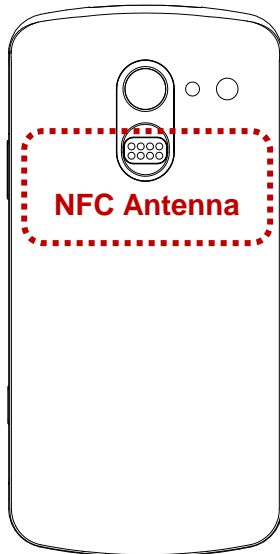
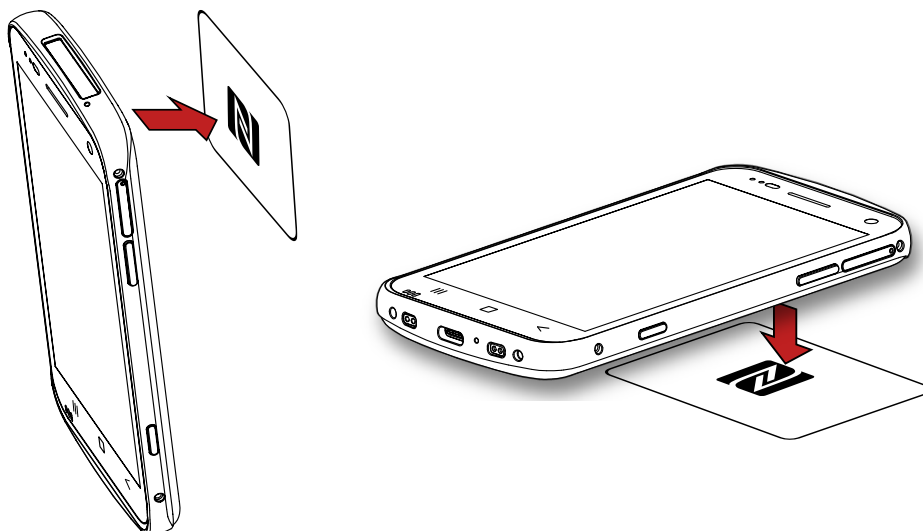

Figure 87 NFC tagging



Wireless

RFID

Connect PM30 to RFID reader, RF300 (sold separately). Devices can be connected with each other through a wired connection or Bluetooth connection. For both connect methods, RFID Control application is required. Download RFID Control from [Service Portal](#) and install the app on the PM30.

i **Note:** Find more detail in *RF300 User manual* and *RFID Control User guide*.

To attach the PM30 to RF300,

1. Insert the PM30 into the retention fixture of the RF300 from the top

Figure 88 Installing PM30 to RF300_1

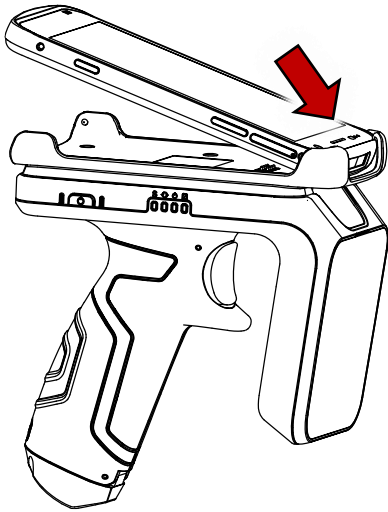

2. Push the bottom side of the PM30 down

Figure 89 Installing PM30 to RF300_2

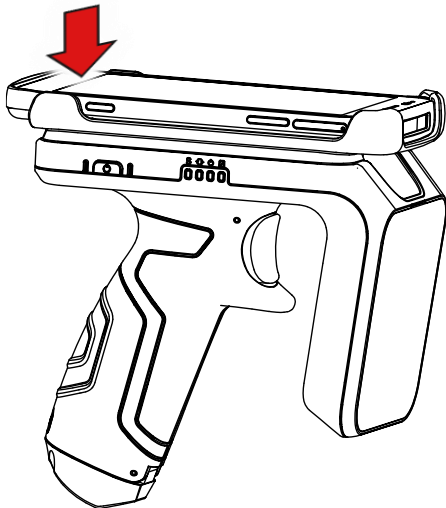

System Maintenance

System Information

There are two ways for checking system information, on settings and on EmKit.

On Settings

Go to **Settings**  > **About phone** . Following information can be found.

- Device name
- Phone number
- Emergency information
- Legal information & Certificates
- Model & SIM status
- Hostname
- Android version
- IMEI
- IP address
- Wi-Fi MAC address
- Bluetooth address
- Build number

On EmKit

Go to **EmKit**  > **System Information** . Following information can be found.

- Processor information
- Version information (Android version, OS image version, SDK version, etc.)
- Manufacturer information (Serial number, Part number, etc.)
- Device information (Scanner, Camera, Audio, Display, etc.)
- Battery information (Battery charging status, etc.)
- App version information (Version of EmKit apps)

System Maintenance

OS Update

Periodic update improves the performance of the device. Point Mobile provides up-to-date OS version via Service Portal and FOTA. Update the device via storage, OTG port, and FOTA server. Depending on the workspace environment, choose more suitable method.

i **Note:** Please backup your data before starting the update process.

OS update via storage

To update the OS using storage,



1. Download an OS image file into the root folder of microSD card or device internal storage
2. (In case of using SD card) Insert SD card to the device and then turn the device on
3. Go to **Settings**  > **System**  > **Advanced** > **System Update**
4. Check if the OS image file shows up under **AVAILABLE VERSIONS**

Figure 90 OS update via storage



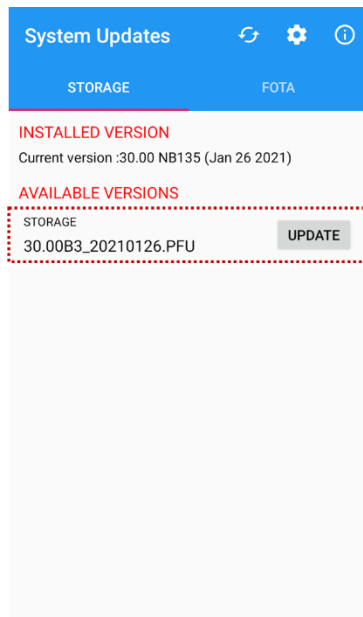

5. Tap **UPDATE** to start the update process

i **Note:** If the OS image file doesn't show up in **AVAILABLE VERSIONS**, check the file is placed in the root folder of storage. System only can recognize the file in the root folder.

System Maintenance

OS update via OTG port

PM30 supports the USB OTG feature.

1. Prepare a formatted USB flash drive for OS update
2. Copy an OS image file to the root folder of the flash drive
3. Connect the flash driver to the PM30
4. Go to **Settings**  > **System**  > **Advanced** > **System Update**
5. Check if the OS image file shows up under **AVAILABLE VERSIONS**
6. Tap **UPDATE** to start the update process

OS update via FOTA

If PM30 can connect to a network, use the FOTA server for the update.



1. Connect the device with a network
2. Go to **Settings**  > **System**  > **Advanced** > **System Update**
3. Tap **FOTA** tab or Swipe left to move to **FOTA** tab
4. If there is an OS version newer than device's one, the server shows the new OS information

Figure 91 OS update via FOTA



System Maintenance

5. Tap **Download**
6. Tap **OK** on the **OS Update** dialog to start to download the OS image file
7. To complete the update, rebooting is required. Tap **OK** on the **Restart required** dialog to restart the device

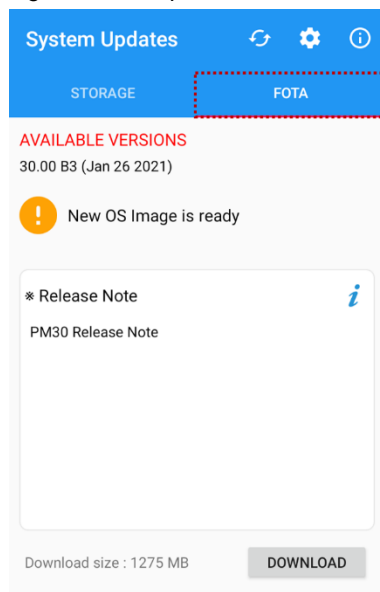
i **Note:** Basically, OS update via FOTA works over Wi-Fi or Ethernet only. To enable the OS update over Mobile Network too, uncheck the setting value in FOTA Settings. Downloading over the Mobile network may result in additional charges.

Figure 92 FOTA Settings

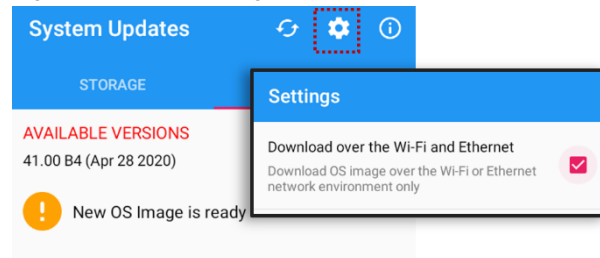

System Maintenance

Factory Data Reset

When PM30 work abnormal or there is a need to reset the device, follow the steps below to perform a factory data reset.



Caution: *Factory data reset will erase all personalized settings and data saved in the device, such as Google account, apps, user data, etc. And factory data reset cannot undo.*

Factory data reset via Settings app

If the device can be turned on and access **Settings**,



1. Navigate to **Settings**  > **System**  > **Advanced** > **Reset options**
2. Tap **Erase all data (factory reset)**
3. After being aware that factory reset will erase all data from the internal storage, tap **Erase all data**

Figure 93 Factory data reset



4. Tap **Erase all data** again to start the factory reset process

System Maintenance

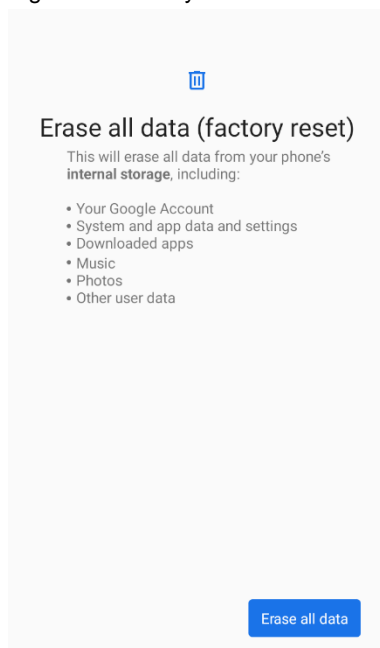
Factory data reset via recovery mode

If device works abnormal so does not turn on, try to perform factory data reset through Android recovery mode.

1. Press and hold **power button** and **volume up** buttons simultaneously when PM30 turned off

Figure 94 Recovery mode button combination

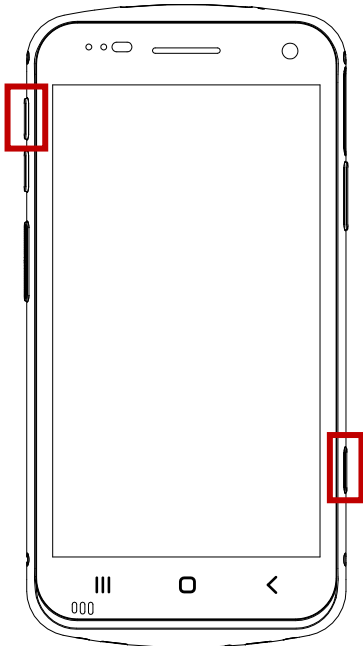

2. After short vibration, release the power button
3. Using the keys below, select **Wipe data/factory reset**
 - **Move down / up** – Press volume down / up button
 - **Select the menu** – Press power button
4. After wiping the data, select **Reboot system now**

Figure 95 Factory reset via recovery mode

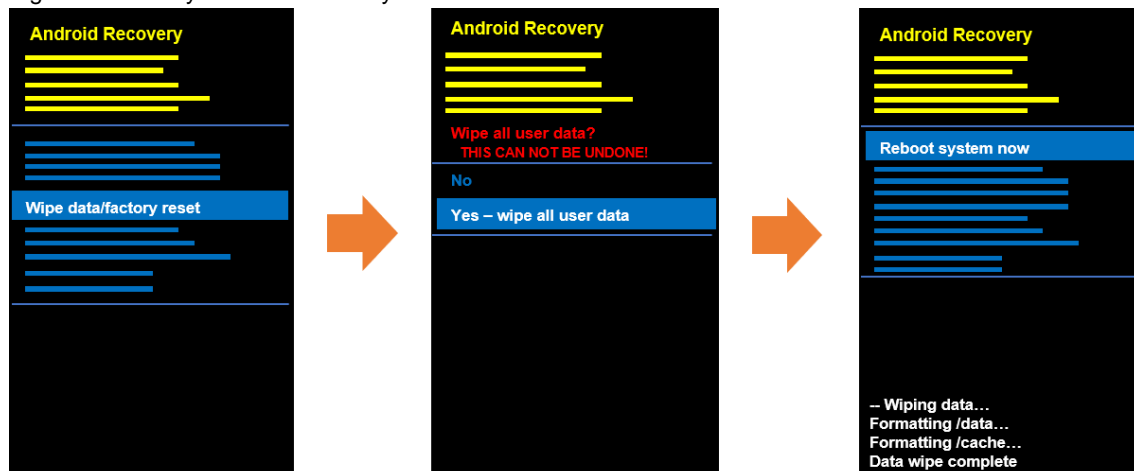

Accessories

PM30 supports below optional accessories.

Category	Accessory Name	Usage
Sled type	Gun handle	Provide additional scan trigger button (Programmable)
	RF300	Reading UHF RFID tags
Charging cradle	SSC (Single Slot Cradle)	Charge PM30 with sled accessory
	2SC (2 Slot Cradle)	Charge PM30 and PM30 with PMBooster or protection case
Wireless charging	Wireless charging pad	Charge PM30 wirelessly
Extended battery case	PMBooster	Provide extended battery capacity to PM30
Protective case	Protective case	Protect PM30 from physical damage

Gun Handle

Attach a gun handle to PM30 and use additional programmable button. The button is used for triggering scanner usually.

Figure 96 PM30 with gun handle

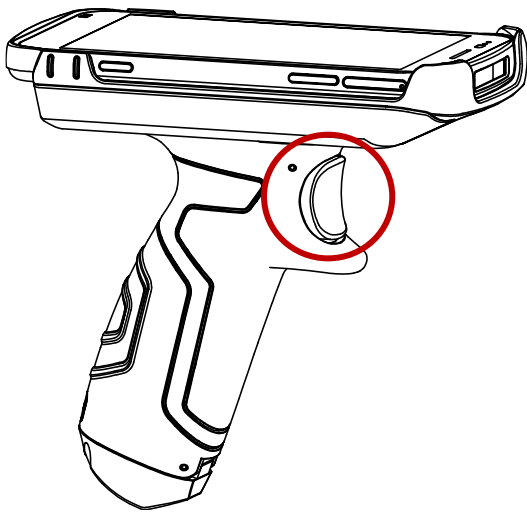

RF300 (UHF RFID Reader)

RF300 is mounted on the PM30 and used to read RFID tags. To connect the devices, RFID Control application is required. For more detail, see [RFID](#) chapter or RF300 User Manual.

Accessories

Single Slot Cradle (SSC)

SSC is a charging cradle for a PM30 with sled type accessory mounted. SSC can charge,

- PM30 with RF300 mounted
- PM30 with gun handle mounted

PM30 and RF300 will be charged simultaneously when using SSC.

For more detail, find [Charge the device – Charging with Cradle](#) chapter or SSC Quick start guide.

2 Slot Cradle (2SC)

2SC is a charging cradle which can charge 2 unit of PM30 simultaneously. 2SC can charge,

- PM30 alone
- PM30 with PMBooster
- PM30 with protective case

If a PM30 with PMBooster mounted is installed into 2SC, PM30 is charged first and after fully charging the PM30, PMBooster will be charged.

For more detail, find [Charge the device – Charging with Cradle](#) chapter or 2SC Quick start guide.

Wireless Charging Pad

PM30 supports wireless charging. Wireless charging pad can charge,

- PM30 alone
- PM30 with protective case

Refer to [Charge the device – Wireless charging](#) chapter to find out how to charge PM30 by wireless charging pad.

Accessories

PMBooster

PMBooster is an extended battery case for PM30. PMBooster includes a rechargeable 3250mAh Li-ion battery so it can charge the PM30 through USB Type C connector.

To use PMBooster, slide the PM30 into PMBooster top to bottom as below figure. Before installing the PM30, remove all mounted accessories from PM30.

Figure 97 Insert PM30 to PMBooster

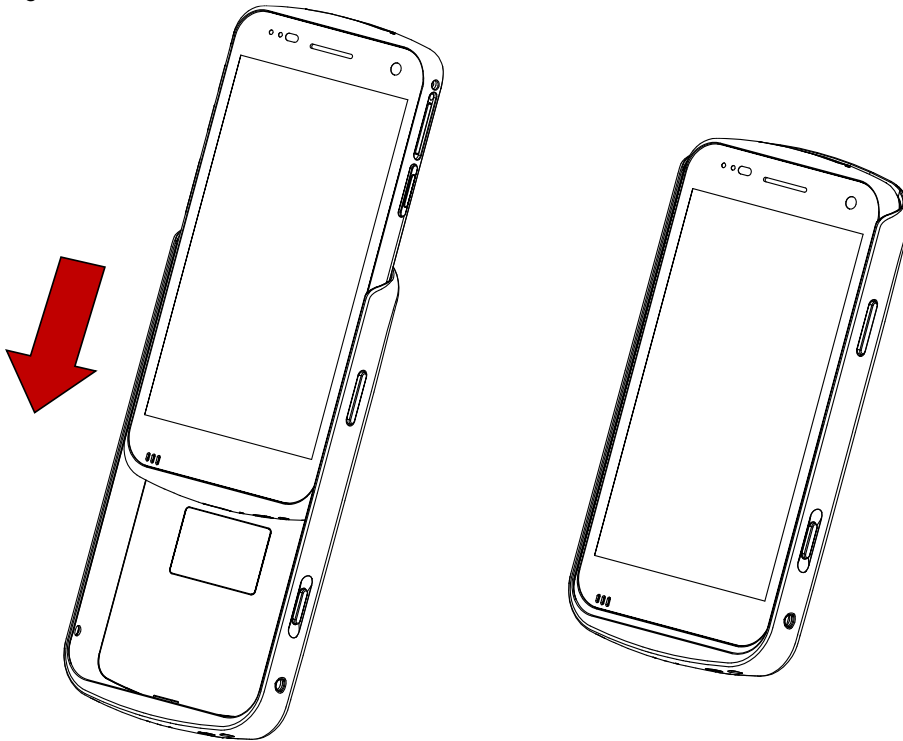

PM30 with PMBooster mounted can be charged using USB Type C cable or 2SC.

For more detail, find PMBooster Quick start guide.

Safety Information

Battery Safety Information

Follow battery safety guidelines in this manual for safe usage and disposal of Li-ion batteries. Improper battery usage may result in an explosion, fire, or other critical hazards.

Battery Usage & Disposal Guidelines

1. Use only Point Mobile approved batteries and charging accessories. Other batteries and charger may damage the device.
2. Do not disassemble or modify the battery. Do not bend, shred, deform the battery.
3. Do not expose the battery to excessive heat or cold. Do not place the battery into a microwave oven or dryer.
4. Do not short-circuit the battery or allow a foreign object to battery contacts.
5. Do not burn, expose to water, or other liquids the battery.
6. If battery leakage is observed, avoid any contact with the skin or eyes. If contact has been made, wash the affected area with water for 15 minutes, and seek medical attention.
7. Follow the local regulations for the disposal of used batteries.
8. Do not store or charge the battery in direct sunlight or in areas prone to get hot such as in a parked vehicle, near a heat duct, or close to other heat sources.

Battery Charging Guidelines

1. Do not charge the battery in or near areas with materials that could obstruct charging or cause a short-circuit.
2. Do not charge the battery in the excessive hot or cold area.
3. Separate the charger from the battery as soon as possible when the battery is fully charged.
4. Charge it at least once every six months to prevent full discharge and keep the performance, when you are not using the battery for a long period.



Notice: *The battery is consumable goods. Point Mobile provides warranty for battery in 6 months after purchase. If you suspect the battery swelling, change the battery and contact Point Mobile to use safely.*



Point Mobile. Co., Ltd.

Offline

Tel: +82-2-3397-7870~1

ARS: +82-1800-3010

Fax: +82-2-3397-7872

Address: 9F Kabul Great Valley, 32, Digital-ro 9-gil,
Geumcheon-gu, Seoul, Korea 08512

Online

Website: <https://www.pointmobile.com>

E-mail: pm_support@pointmobile.com