



For Android™ 8.1.0

Enterprise Mobility

PM85

User Manual

User Manual

Please note your phone is battery-embedded design with removable battery and battery cover. Unauthorized personnel are strictly prohibited from disassembling the phone. Make sure to use only the power adapter (5V 2A Output AC/DC) that came with PM85.

In case your phone does not work as expected, you are strongly recommended to restart it by pressing and holding the power button for at least 8 seconds until the startup screen appears. If your phone has encountered a serious error and cannot be recovered, you should reset your phone to factory settings by using the menu, either “Backup & Reset”, or “Factory Reset”. For more details, please refer to “Factory data reset” section on page 91

Note: Please be cautious while performing the factory data reset. Because this will erase personalized settings and data saved in your phone, such as SMS, Contacts, Music, etc.

Screenshots in this manual may different compare with latest Android App version

Rev 03

Table of Contents

User Manual	1
Table of Contents	2
Getting Started	4
Major Parts	4
Setup PM85	6
Turn On/Off PM85.....	8
Hot swap the Battery.....	9
Charge PM85.....	11
Learning the basics	14
Use a keypad.....	14
Use a touch screen.....	16
Setup Wizard	18
Home Screen, Apps and Widget.....	26
Status & Notifications Icons.....	37
Set a Lock screen	39
Manage a display.....	41
Make a call.....	46
Add to a contact.....	48
Send a message.....	52
Change a SIM card settings.....	55
Connect to your Wi-Fi network.....	58
Make a Wi-Fi hotspot.....	60
Connect with Bluetooth device.....	62
Use a Camera.....	65
Manage files and folders.....	67
MTP connection with PC.....	74
Scanner Settings	77
Use a Scanner	77
Scan a Barcode	84
OS Update.....	86
OS Image update from a Storage	86
OS Image update from the FOTA.....	89
Factory data reset.....	91

Factory data reset from Settings 91

Force Factory data reset 94

EmKit..... 98

 EmKit Secure 99

 EmKit Remote 103

 EmKit Tools 111

 EmKit Demos 123

Safety and Legal Info..... 127

Major Parts

Getting Started

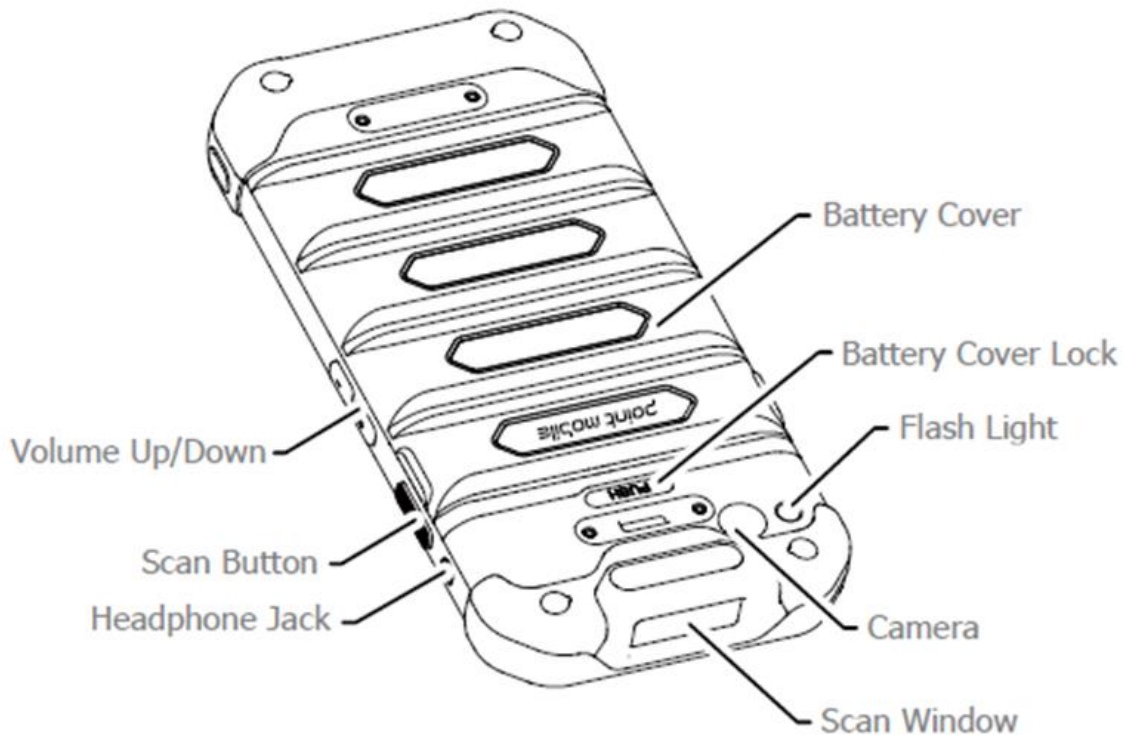
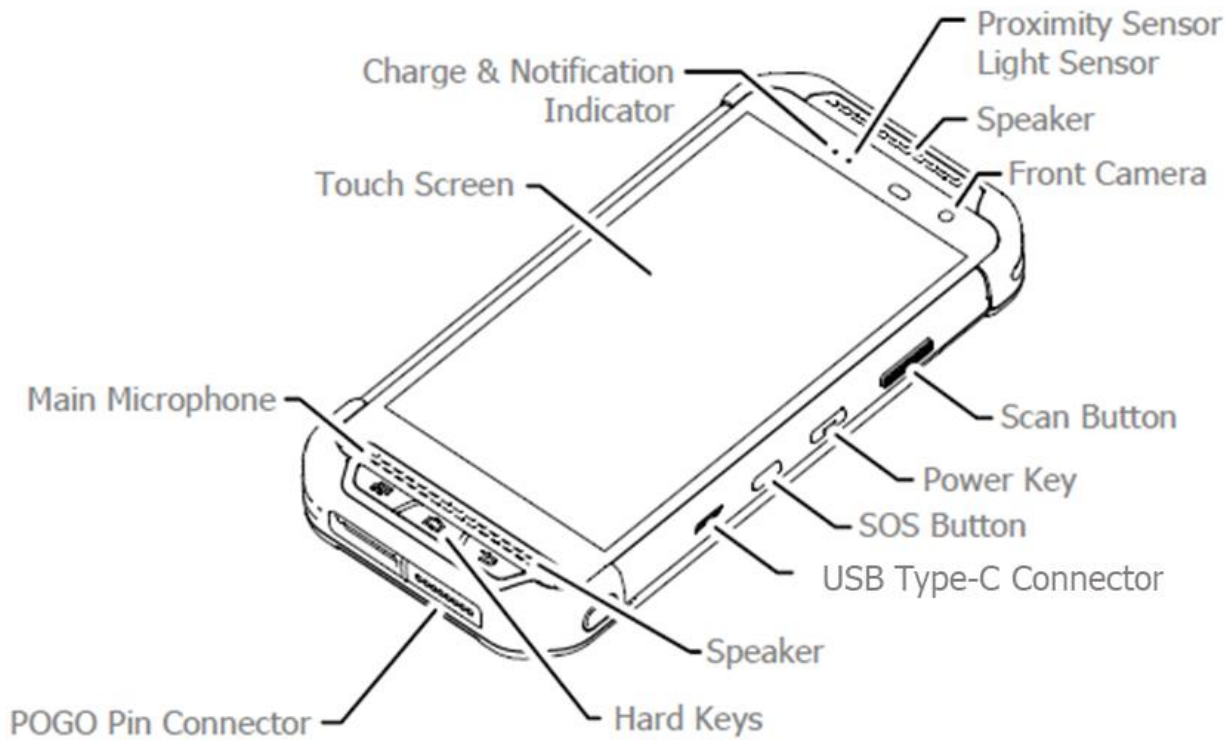

Major Parts

Getting Started

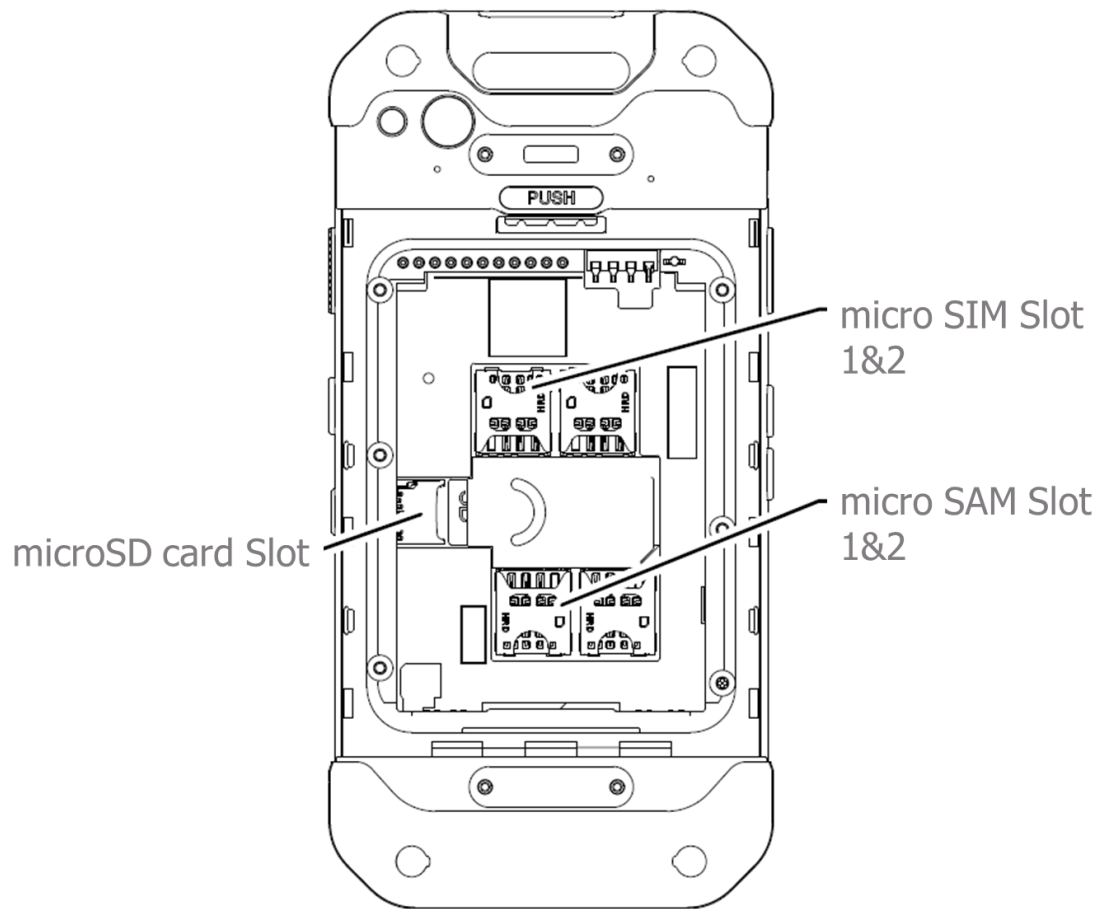

Note 1: PM85 only supports the micro SIM cards. Do not insert a size modified card with SIM adapter. Size modified card is thicker than the standard Nano SIM card and may damage the card slot

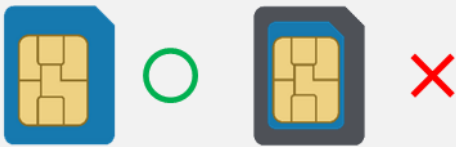

Note 2: PM90 supports up to 32GB microSD card

Setup PM85

Getting Started

Remove the Battery Cover

1. Push down the Battery Cover Lock

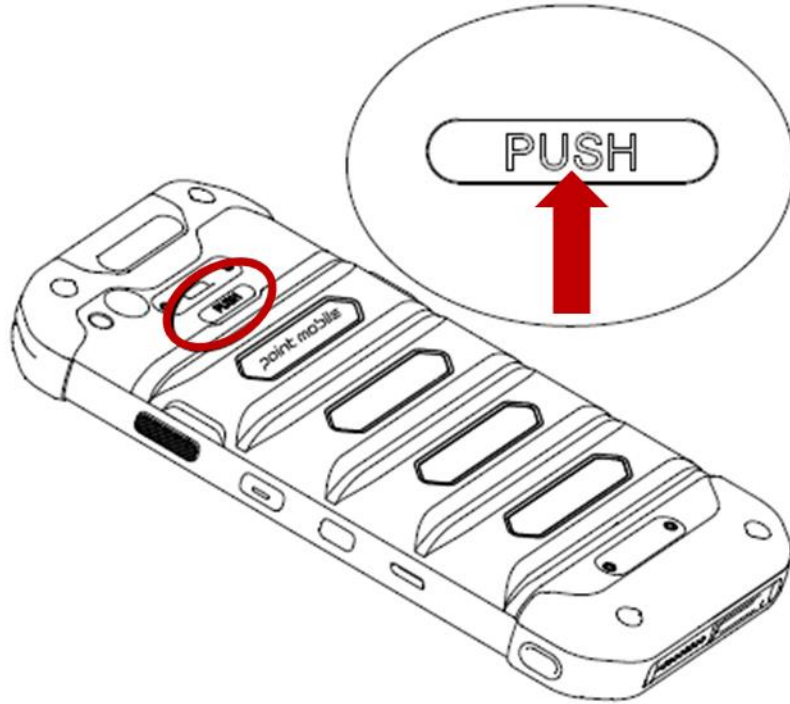

2. Lift up the Battery Cover and open

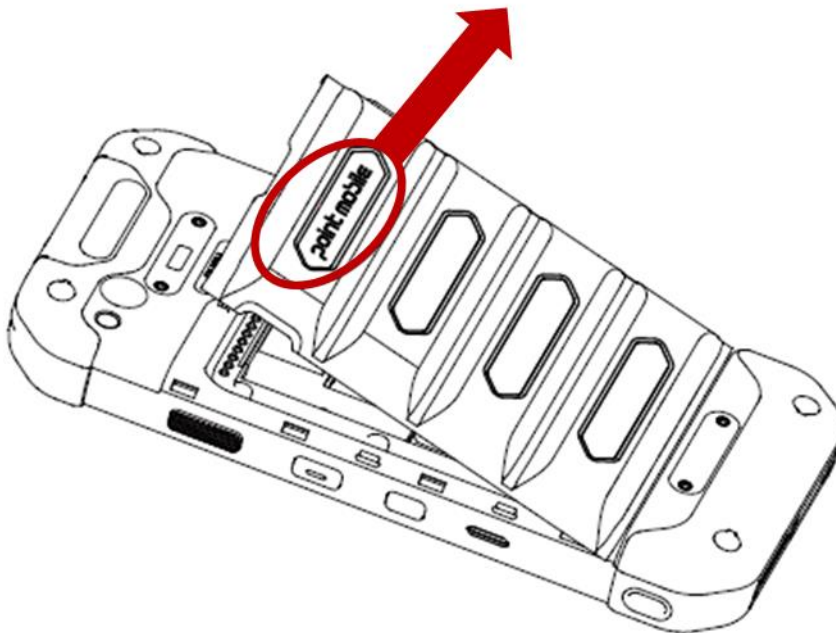

Setup PM85

Getting Started

Insert the Battery

1. Insert Battery from the top first, and then put in the bottom

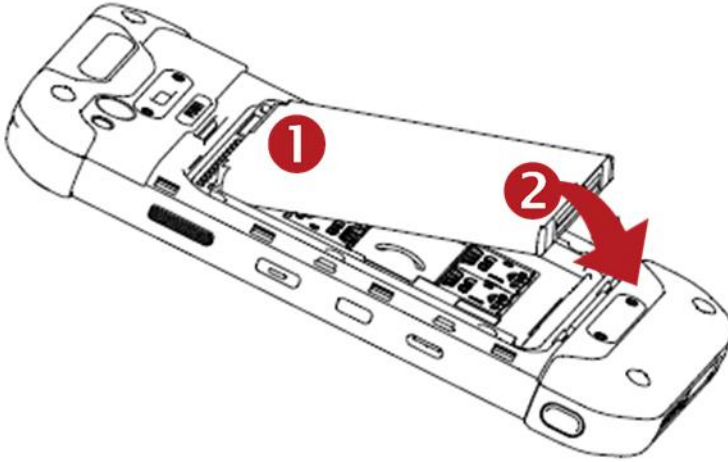

2. Insert the Battery Cover from the bottom first

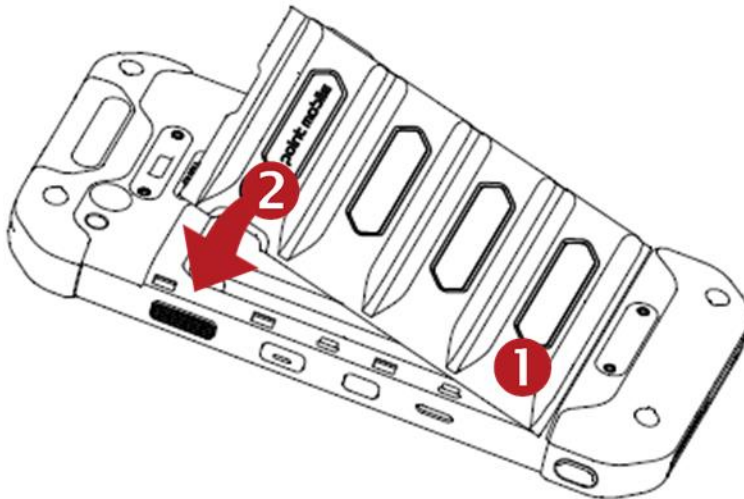

Turn On/Off PM85

Getting Started

Turn On

1. Press and hold the “Power Key” for a few seconds.
2. When PM85 enter to the boot mode, it will display “SMART BEYOND RUGGED” logo
3. Release the “Power Key” and wait until PM85 finish booting

Note: If you cannot turn on your PM85, try below steps

- To turn on PM85, battery needs to be charged certain level. Please charge first
- Press and hold the “Power key” for over 8 seconds to force reboot

Turn Off

1. Press and hold the “Power Key” until you see the power menu

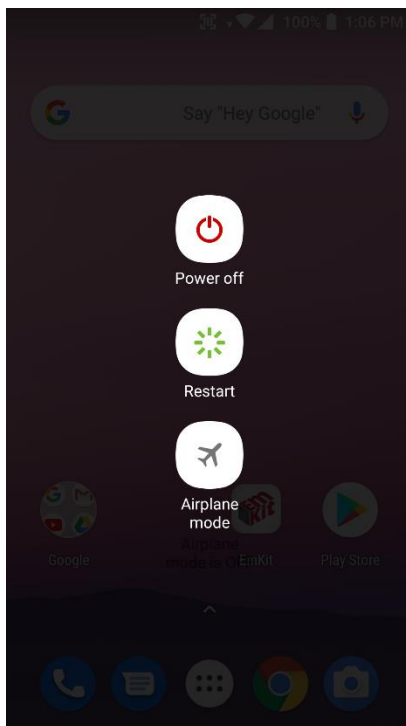

2. Touch “Power Off”

Hot swap the Battery

Getting Started

When Battery level is low, you can replace the battery without turning off and on the PM85

1. Remove Battery Cover

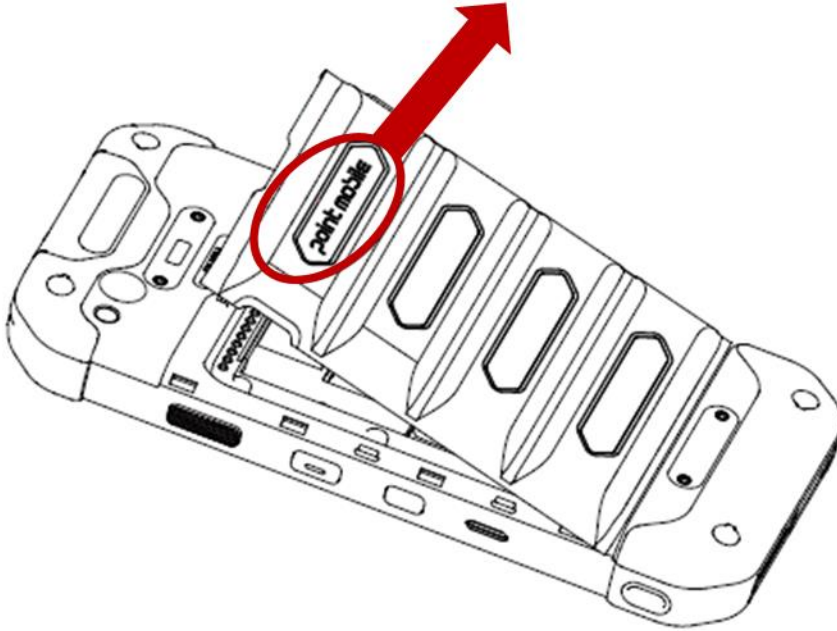

2. Replace the Battery

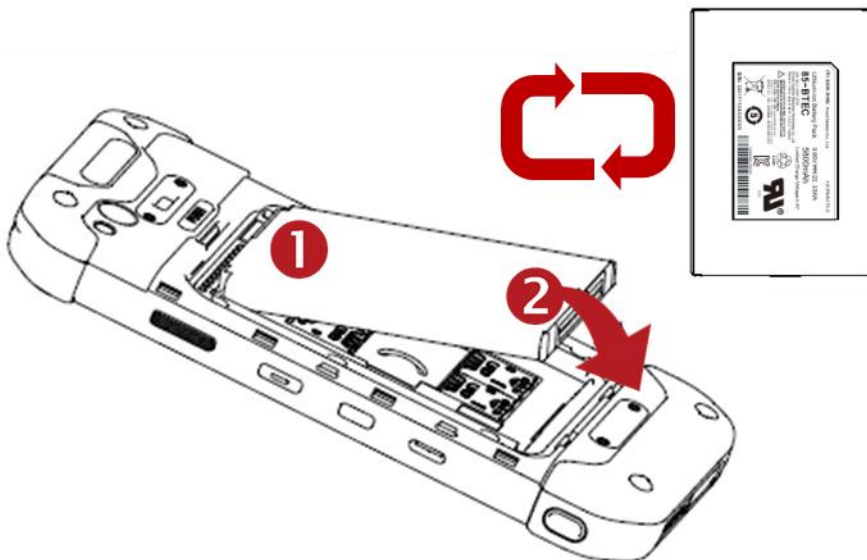

Hot swap the Battery

Getting Started

3. Close the Battery Cover firmly

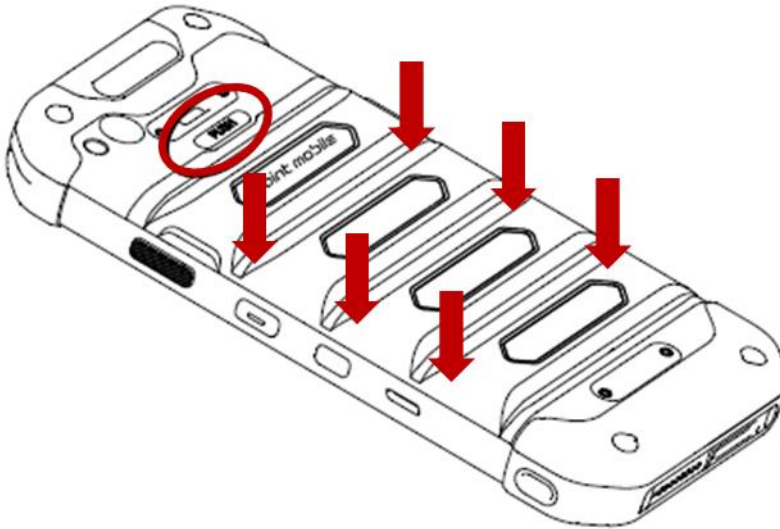

Charge PM85

Getting Started

1. Assemble the country code and AC adapter first. Connect USB cable to assembled AC adapter
2. Connect another side, USB type C connector to the PM85 and apply the power from wall socket

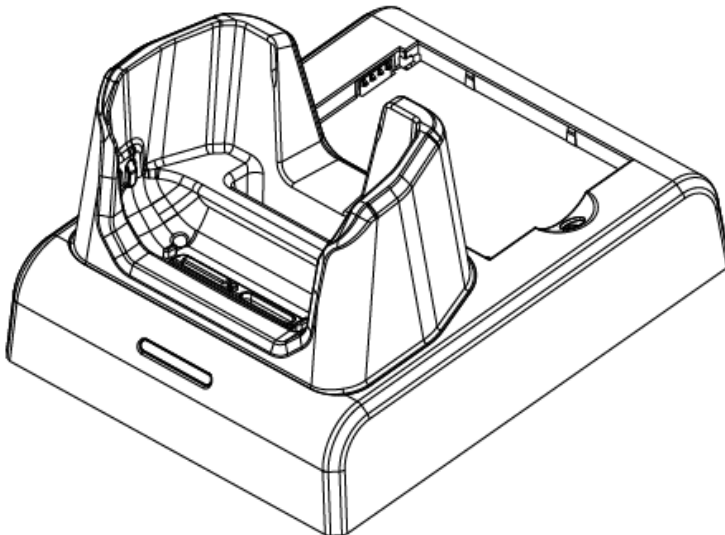
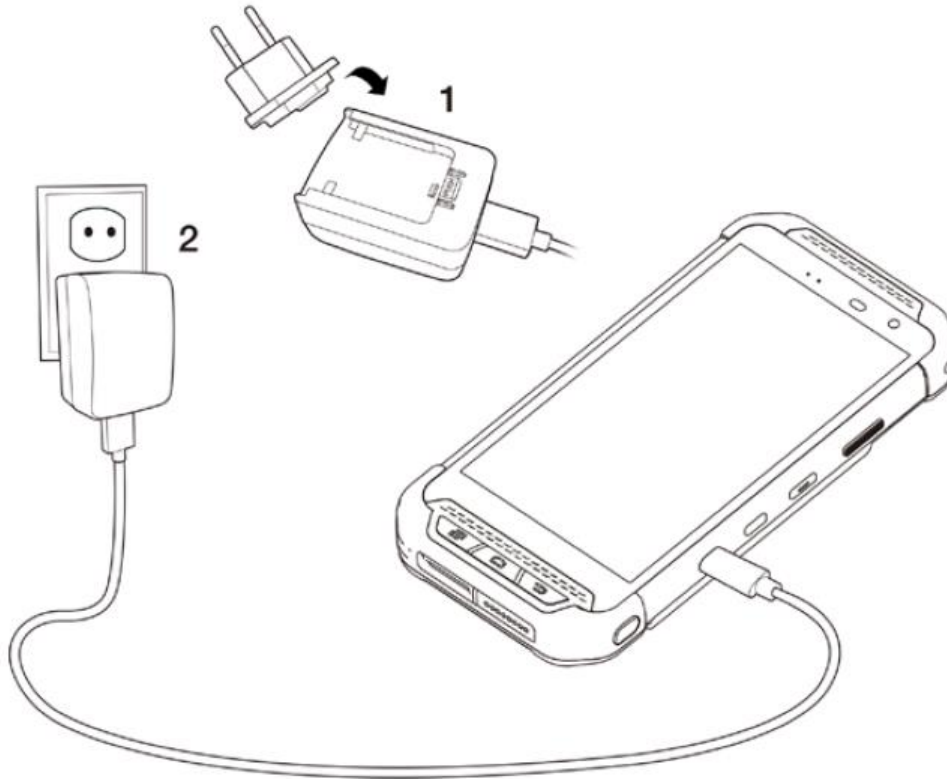

You can also charge the PM80 with cradle (optional accessory)

Charge PM85

Getting Started

- LED indicator will display charging status.

Steady Red	Battery is charging or Battery level is low
Blinking Red	Battery level is critical low
Steady Green	Battery is fully charged

Standard Battery	2,900mAh 3.85V
Extended Battery	5,800mAh 3.85V
Charging time	Standard Battery : About 3 hours Extend Battery : About 5 hours

Note: Always use an original charger and cable from the Point Mobile. Other chargers and cables may damage PM85. In addition, make sure connector, charger, cables are not wet.

Charge PM85

Getting Started

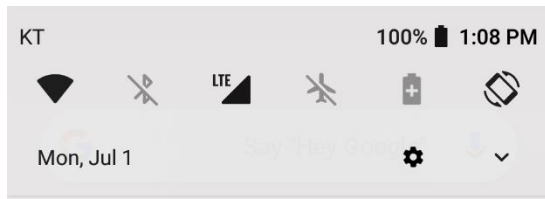

Android System ^

Check USB port

Water is detected in the USB port. Please check your device to make sure it is completely dry before charging. It may take a little while to dry out completely.

Note : You may see this warning message, when the USB cable is connected to the device only. Please connect USB cable into AC adapter or PC first.

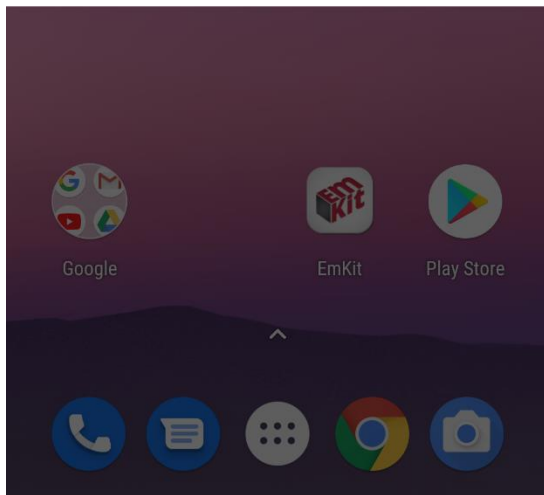

When you have **Check USB port** notification

1. Remove moisture in the USB port first and then connect with USB type C cable
2. If #1 doesn't work, please wait until moisture dry out
3. Please check PM85 connect with USB type C cable only. This case, please connect USB cable in to AC adapter or PC side as well.

Use a keypad

Learning the basics

Power key



Press

- Lock the screen / Light up the screen.

Press and hold

- Display the power menu “Power Off / Restart / Screenshot”

Press and hold over 12 seconds

- Force rebooting

Press and hold the **Power key** and **Volume Down key** together

- Screen capture

Volume keys



In general

- Adjusts the media and ringtone volume
- **Mute** the ringtone during an incoming call (Volume Up / Down key)



In voice call

- Adjusts the volume (Speaker or Headphone)

In camera preview

- Take a photo (Volume Up / Down key)

Scan Button



When **Scan Wedge** mode is activated

- By pressing, PM90 scan the barcode

SOS Button



Press to launch assigned app in emergency situation

You can set **EmKit - Program Buttons**

Use a keypad

Learning the basics

Front Keys

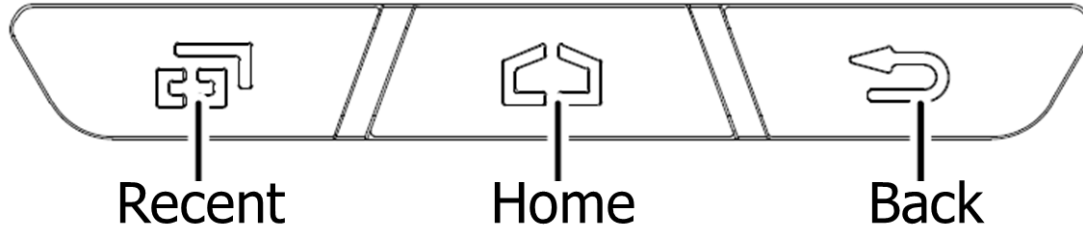

Recent App Press to see recently used apps

Home From any apps or screens, press to return to the Home screen

Back Press to go back to the previous screen, or to close a dialog box, options menu, notification panel, etc

Use a touch screen

Learning the basics

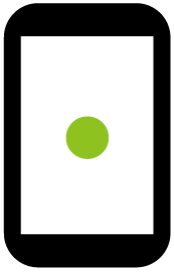

Touch

One-finger press

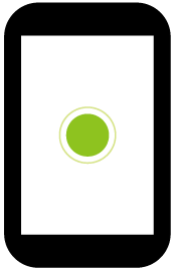

Double touch

One-finger press, lift, one-finger press, lift for “Zoom in”



Long press

One-finger press, wait, lift for “Select an item”

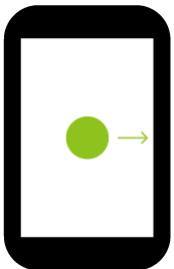

Drag, Swipe, or Fling

One-finger press, move, lift for “Scroll” or “Tilt”

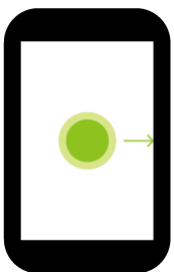

Long-press drag

One-finger press, wait, move, lift for “Pick up and move” or “select multiple items”

Use a touch screen

Learning the basics

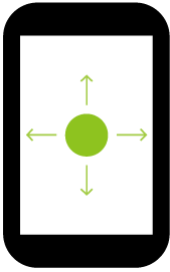

Scroll

Vertical or horizontal swipe in a single direction

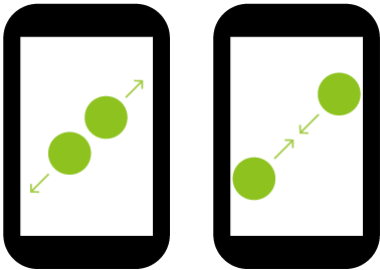

Pinch Open & Close

Two-finger press, move outwards and inwards, lift for “Zoom in and out”



Rotate

When PM85 is turning sideways, screen orientation is changing

Setup Wizard

Learning the basics

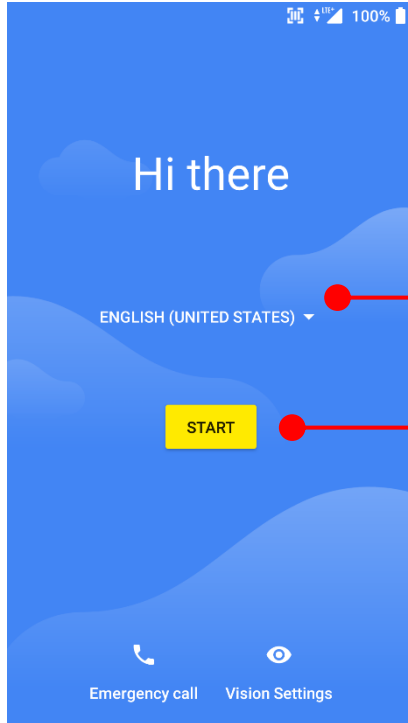

When you power on your device very first time or boot after factory reset, you need to setup your device first

Language Selection

- Choose your language during setup process.

Touch here to start setup your device

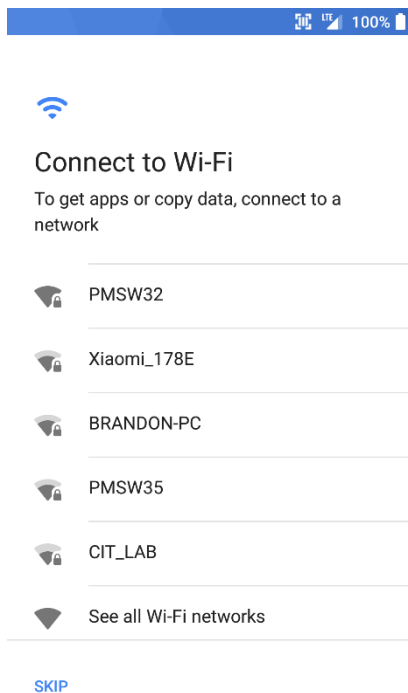

To setup your device, Android requires internet connection. Please connect to your Wi-Fi network or use mobile network in this step



Icon means: Open Wi-Fi network. You don't need to enter the password



Icon means: Secured Wi-Fi network. To connect this Wi-Fi, you need to enter the password

Setup Wizard

Learning the basics

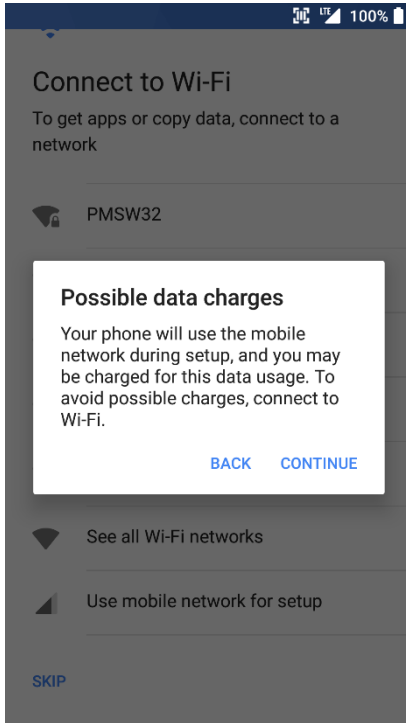

Note: If you choose **Use mobile network for setup** option, you may be charged for mobile data usage.

Setup Wizard

Learning the basics

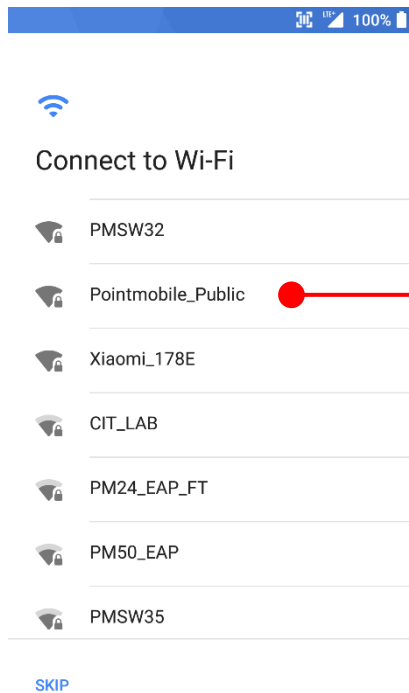

Please select Wi-Fi network and input the password (If required)



Icon means: Open Wi-Fi network. You don't need to enter the password



Icon means: Secured Wi-Fi network. To connect this Wi-Fi, you need to enter the password

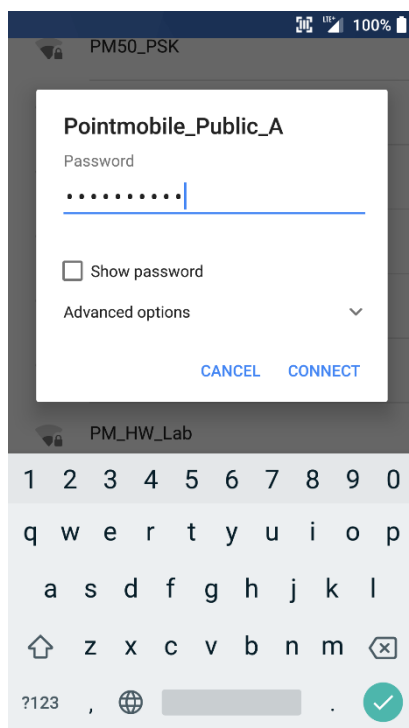

Setup Wizard

Learning the basics



Copy apps & data

Transfer apps, photos, music, and more.
Choose what to copy later.



Copy your data

From an Android or iPhone® device, or the cloud



Set up as new

Get a fresh start

After internet connection, Android will ask set PM85 as new device or copy apps & data from other google account

Copy your data

- You can copy your settings from other Android phone or Google account or iPhone

Set up as new

- Set your PM85 as your new device



Bring your data from...



A backup from an Android phone

Use your old phone to copy data wirelessly



A backup from the cloud

Sign in with your username & password



An iPhone® device

Copy your data options

DON'T COPY

Setup Wizard

Learning the basics



Copy apps & data

Transfer apps, photos, music, and more.
Choose what to copy later.



Copy your data

From an Android or iPhone® device, or the cloud



Set up as new

Get a fresh start

Setup as new setup process

- Touch here to set your PM85 as your new device



Sign in

with your Google Account. [Learn more](#)

Please sign in with Google Account

[Forgot email?](#)

[Create account](#)

[Skip](#)

Next

You can skip this Google Account sign in process and set later.

Navigate to **Settings** → **Users & accounts** → **Add account** → **Google**

Setup Wizard

Learning the basics



Name

Adding your name allows your phone to personalize some apps.

Name

e.g. Joe Smith

After your Google account sign in, you can set PM85's name. Touch here to set a name

NEXT



Protect your phone

Prevent others from using this phone without your permission by activating device protection features. Choose the screen lock you want to use.

Pattern

PIN

Password

Not now

Choose security option for lock screen. You set specific pattern or PIN or password here. You may skip this process and set later. Navigate to **Settings → Security & location → Screen lock**

Setup Wizard

Learning the basics



Google Services

Tap to learn more about each service, such as how to turn it on or off later. Data will be used according to Google's [Privacy Policy](#) (including [collection, storage and usage of personal information](#)) and the [Location Terms of Service](#).

Location

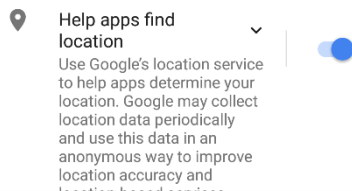

MORE

To review the Google services option, please touch **MORE** button. You can turn On/Off specific service



and other improvements. Some aggregate data will also help Google apps and partners, such as Android developers. If your additional Web & App Activity setting is turned on, this data may be saved to your Google Account.

Install updates & apps

By continuing, you agree that this device may also automatically download and install updates and apps from Google, your carrier, and your device's manufacturer, possibly using cellular data. Some of these apps may offer in-app purchases. You also hereby consent and grant preloaded Google apps permission to access information and functions on your device. See [this page](#) for more information on usage of these permissions.

By tapping "Accept," you agree to the [Google Terms of Service](#). You also confirm your selection of these Google services settings. Note: The [Google Privacy Policy](#) describes how data is handled when using Google services.

ACCEPT

Choose security option for lock screen. You set specific pattern or PIN or password here. You may skip this process and set later

After your reviewing and set Google services option, touch **ACCEPT** button for next step

Setup Wizard

Learning the basics



Anything else?

Here's one more thing to set up on your PM85. You can also find it later in Settings.



Add another email account



Touch to setup another e-mail account

[NO THANKS](#)

Home Screen, Apps and Widget

Learning the basics

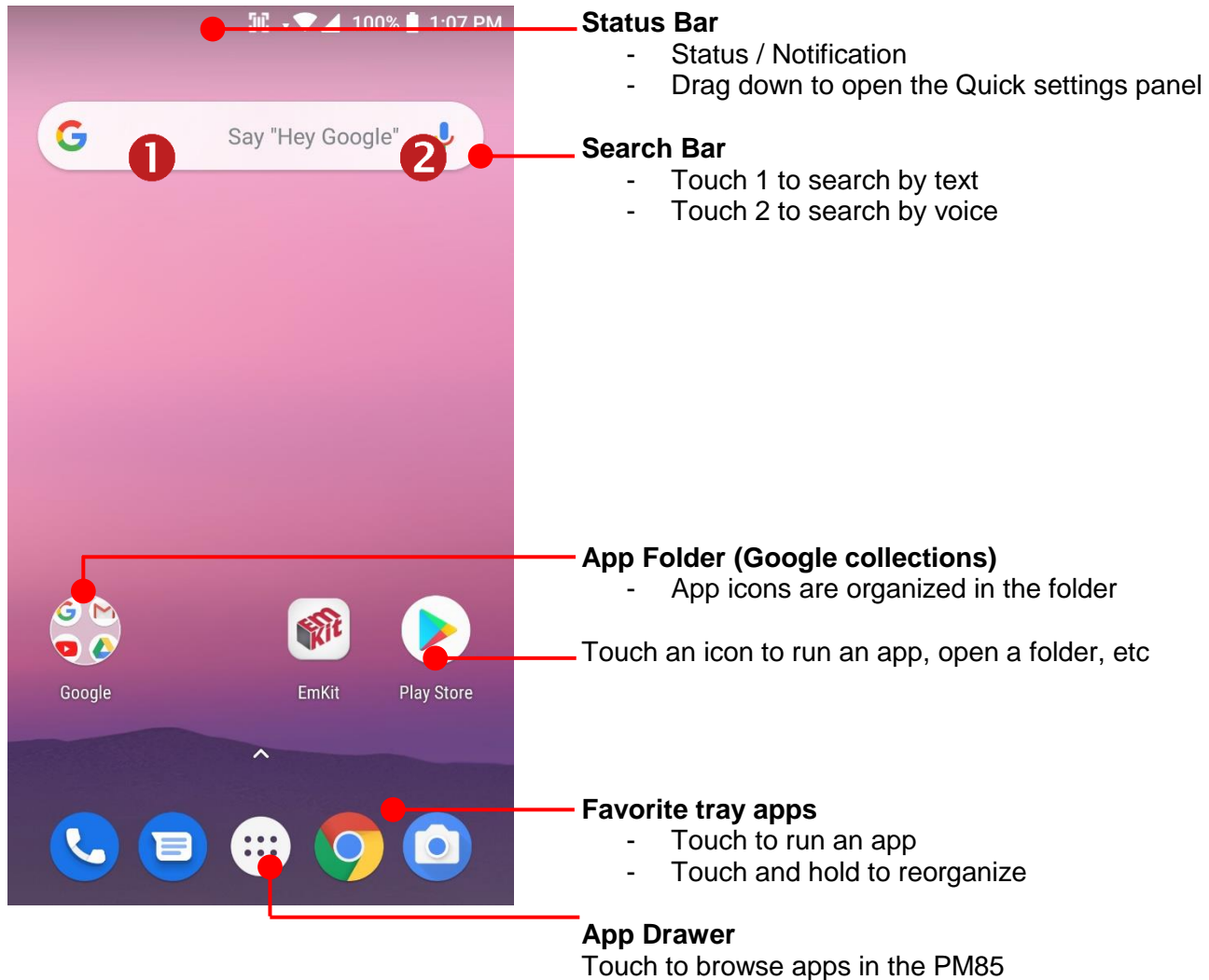

Home Screen, Apps and Widget

Learning the basics

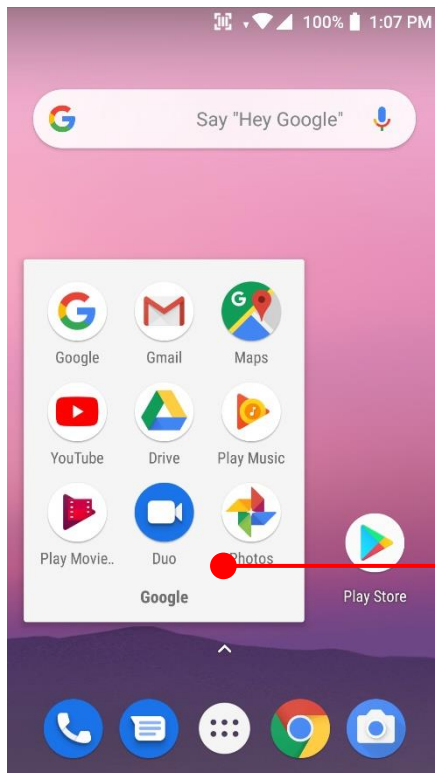

To access app folder (Google collections)

- Touch the app folder then you will see apps in the folder.
- To change app folder's name, touch the bottom area of the folder.

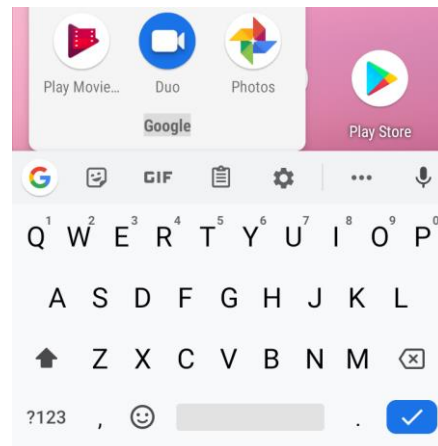

To see App's option for quick access

- Long press the app icon. Then you will see options from the app. Here option may different by app

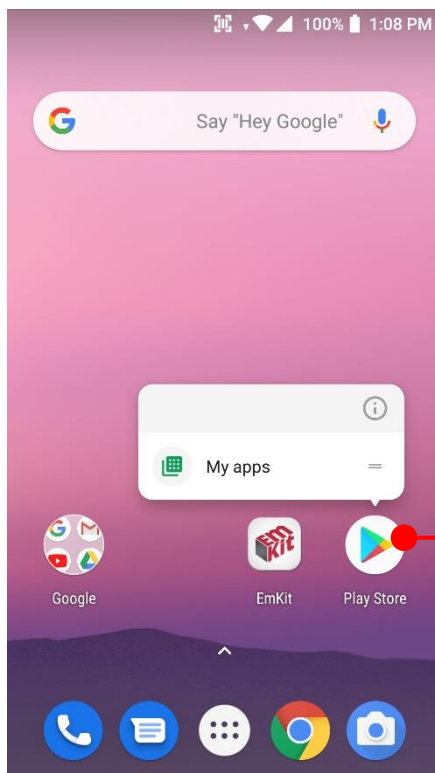

Home Screen, Apps and Widget

Learning the basics

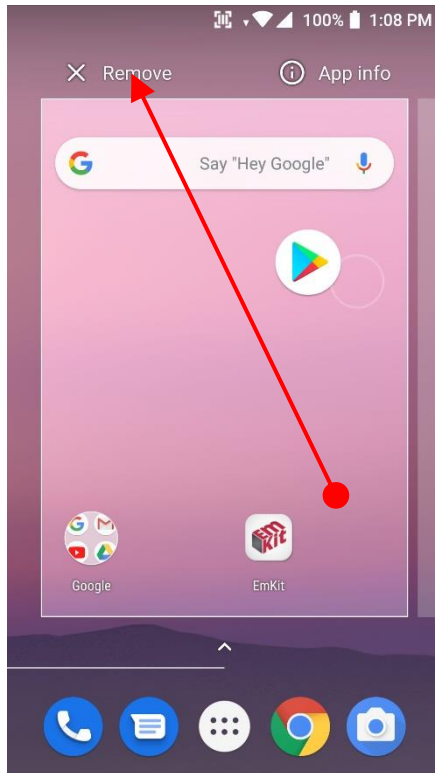

Organize the app icon in the home screen

- Long-press drag the app icon and place where you want. You may place app icon to next panel
- If you want to remove the app icon, drag it to **Remove** area and release

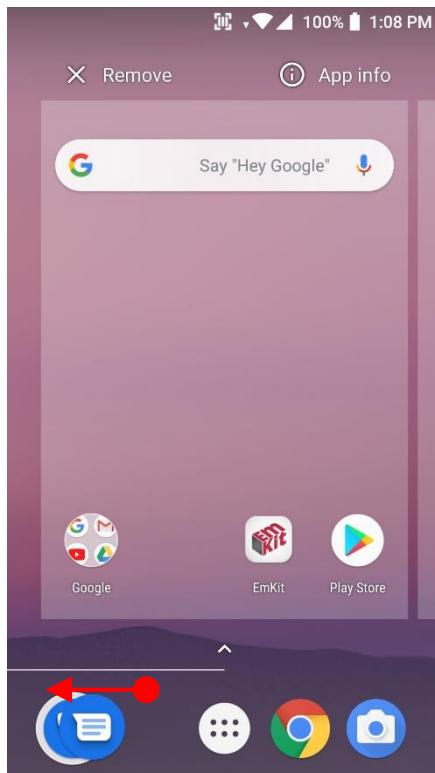

Create "App Folder"

- Long press the app icon to another app icon. This will create the **App Folder**
- To set the folder name, touch the **Unnamed Folder** and rename it

Home Screen, Apps and Widget

Learning the basics

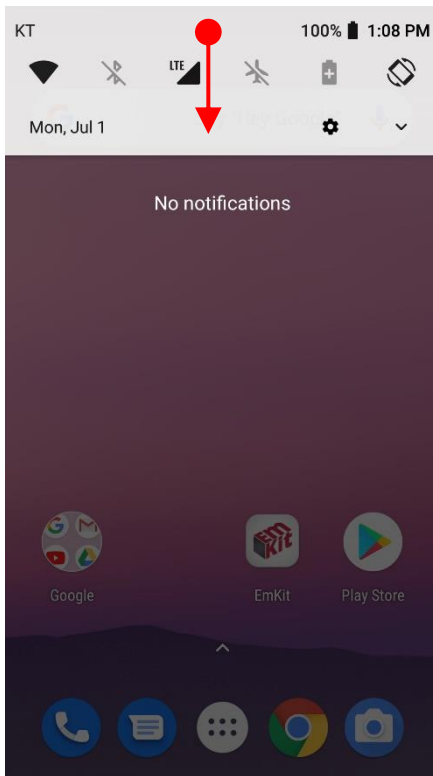

Notification panel

When there is notification from the Android (system) or the App, you can check details by drag down the **Status Bar**.

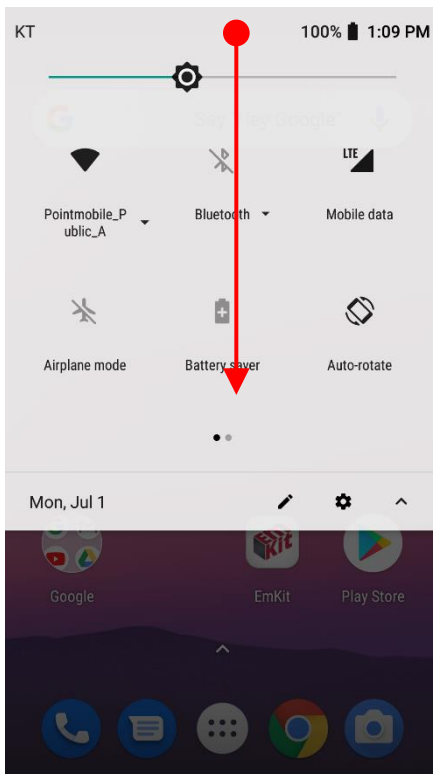

Quick setting panel

You can access **Quick setting panel** by drag down the **Notification panel**. You can enable / disable system settings or change modes easily.

Home Screen, Apps and Widget

Learning the basics

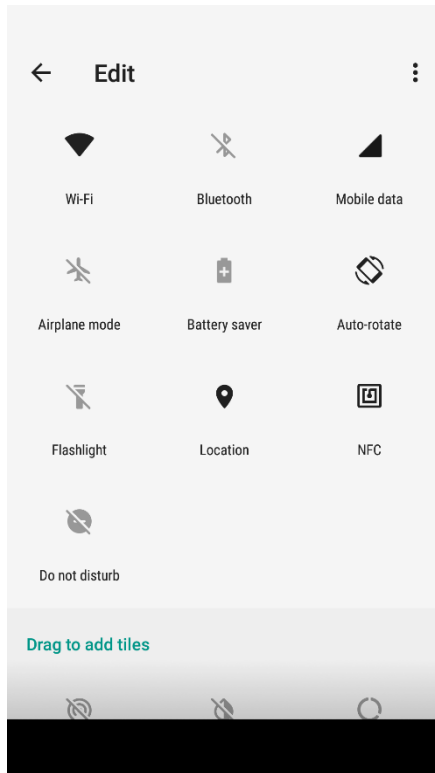

Edit Quick settings panel

To change the order of icons in the **Quick settings panel** or add more icons, touch the  **Edit icon**

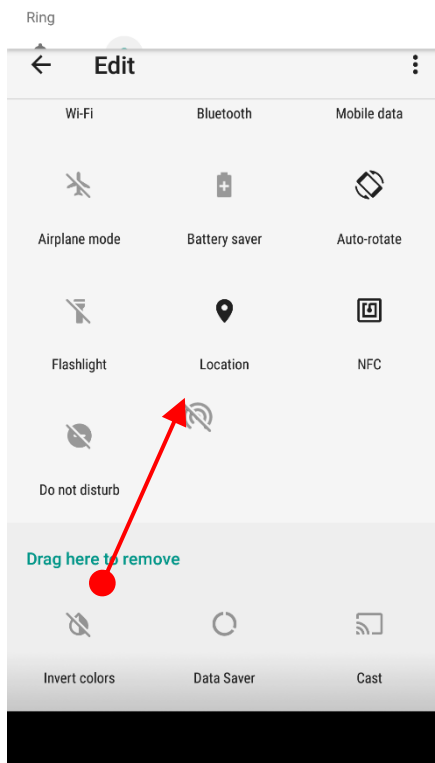

By dragging the icon, you can customize the **Quick settings panel**

Home Screen, Apps and Widget

Learning the basics

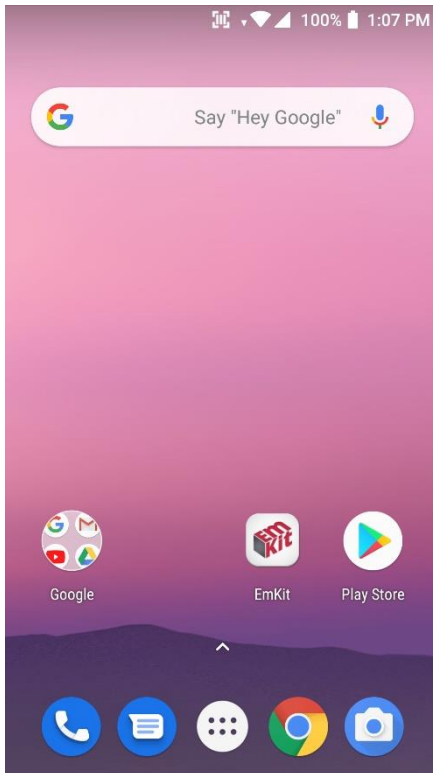

Touch the  App drawer icon, to see apps in your PM85

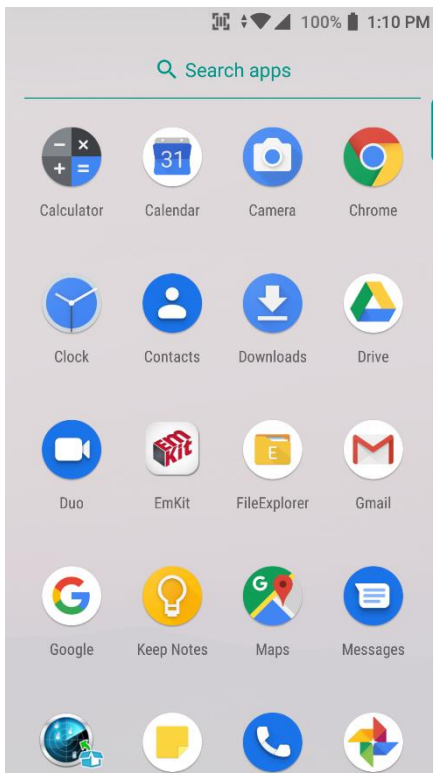

All installed apps are listed alphabetically

- Tap an app icon to run.
- Long press, specific app icon to place to the **Home Screen**.

Home Screen, Apps and Widget

Learning the basics

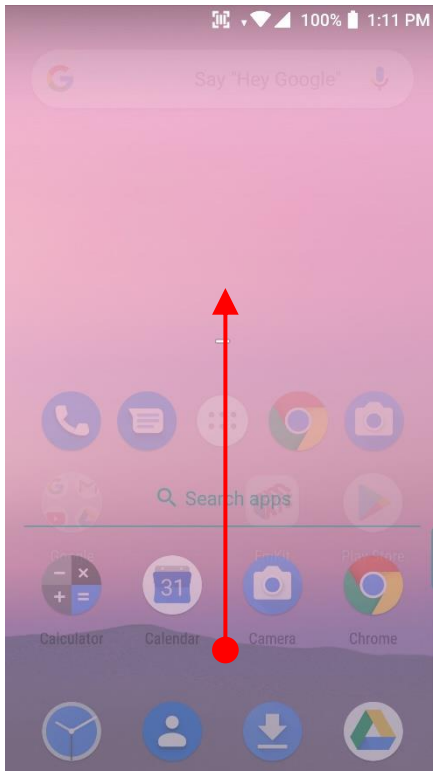

By **drag up** the Favorite tray apps area, you can also access to app list in your PM85

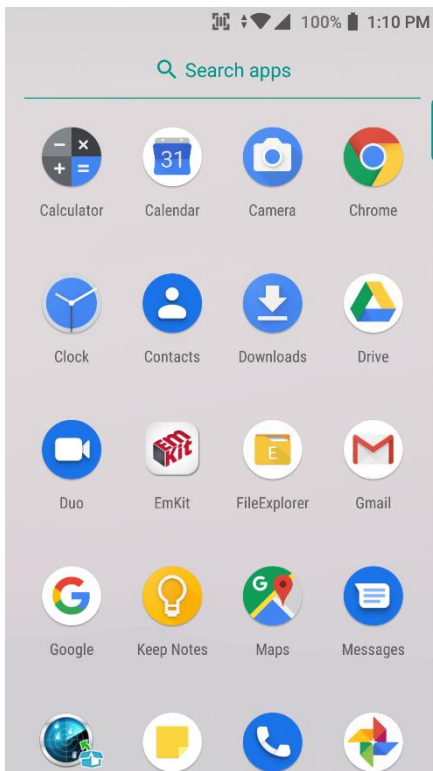

Home Screen, Apps and Widget

Learning the basics

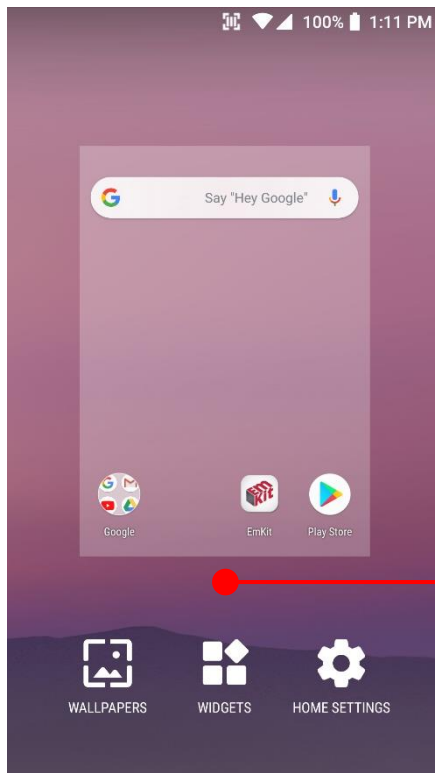

To add a Widget in the Home screen, long press the empty space. Then you will see **WALL PAPERS, WIDGETS, SETTINGS** menu. Touch **WIDGETS**

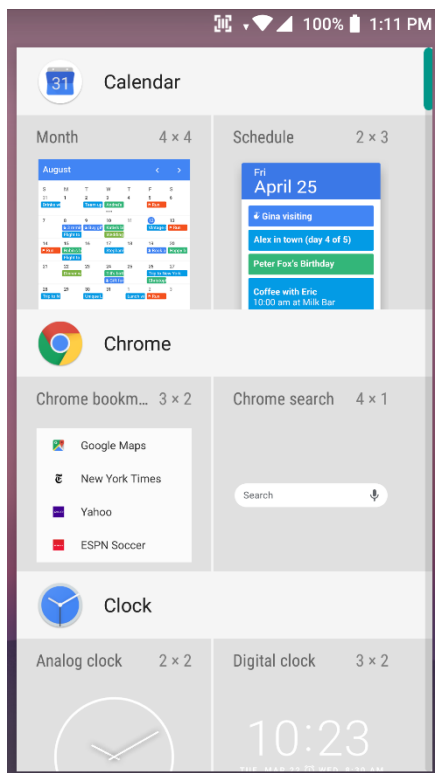

Available widgets are listed. Among the list select the widget which you want to add and place it to the Home screen by drag and drop

Home Screen, Apps and Widget

Learning the basics

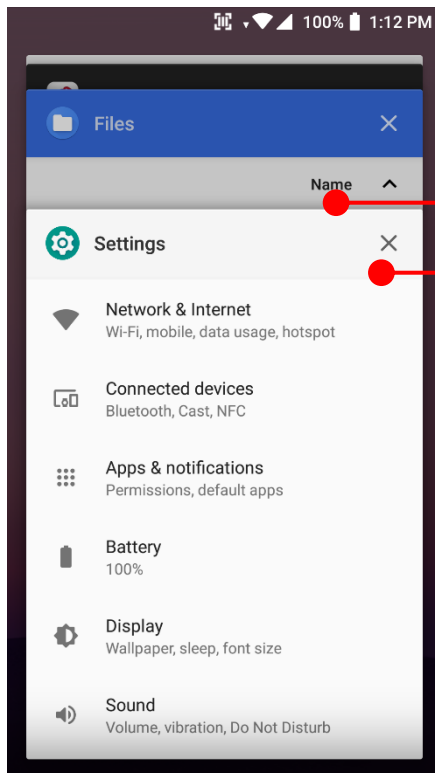

By pressing the  **Recent button** in the keypad, you can see app lists which you have been access

Touch the app, if you want to access again.

If you want to close individual app, long press the app first and then **touch**  icon or **Swipe** the app

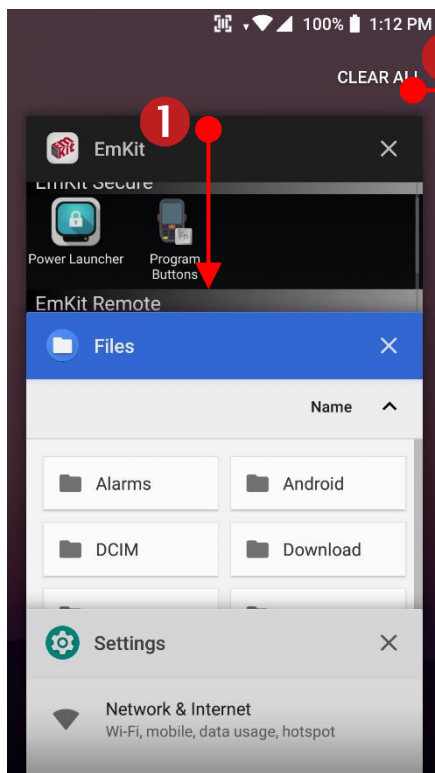

If you close all of the apps,

1. Swipe down the recent app list
2. And then touch **CLEAR ALL**

Home Screen, Apps and Widget

Learning the basics

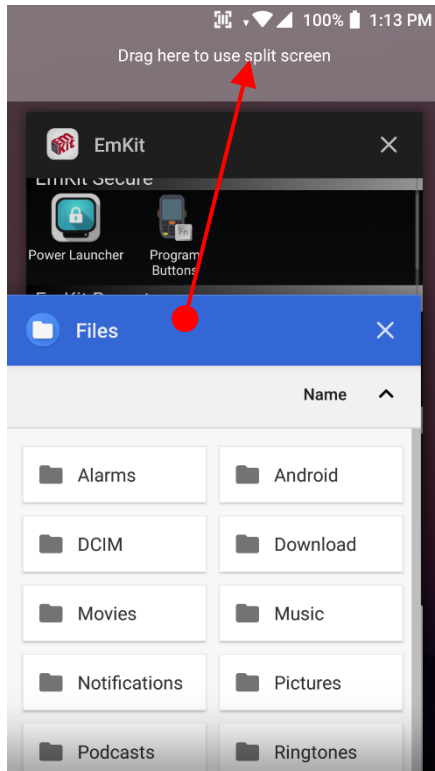

To see the two apps in the screen, please try **Split screen** function.

In the recent app list, long press - drag and drop the one of the app to the top area

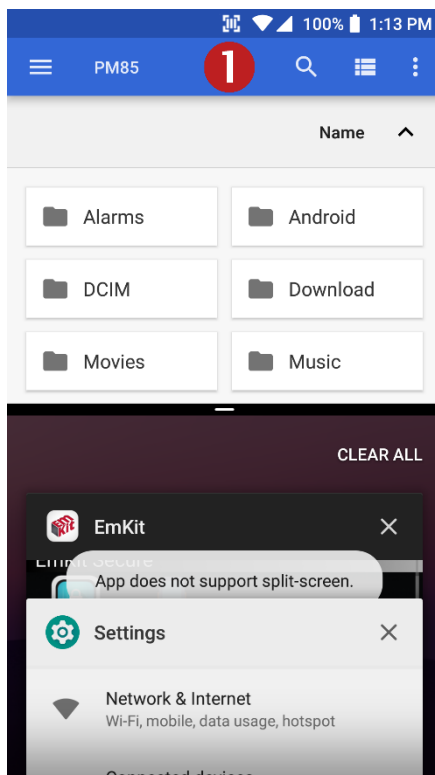

Now primary app is selected. Touch another app to see in the screen.

Home Screen, Apps and Widget

Learning the basics

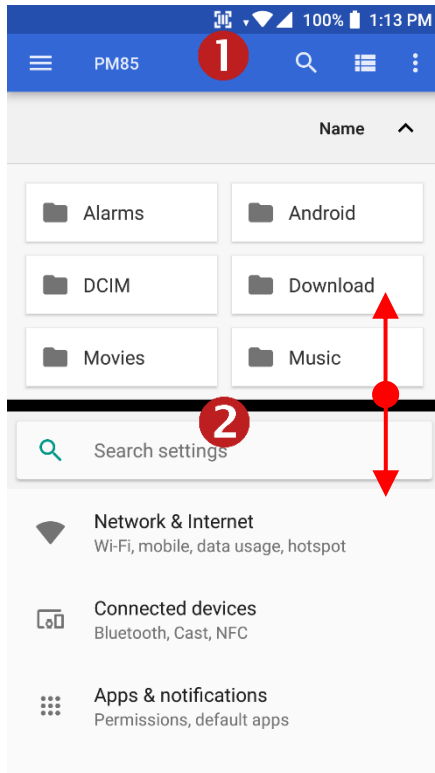

By selecting another app, you can see two apps in the screen





























Note: Some of the app may not support split screen function

By **scroll up or down** the **black bar** in the middle, you can exit split screen mode.

Status & Notifications Icons

Learning the basics



















Status icons

	EDGE connected		Strong signal
	GPRS connected		Good signal
	3G connected		Weak signal
	LTE connected		Connection issue
	No SIM card installed		No data connection
	Airplane mode		Hotspot enabled
	Data communication		
	Wi-Fi turned on		Connected to a Wi-Fi network
	Bluetooth turned on		Connected to a Bluetooth device
	Battery is full		Battery is partially drained
	Battery is low		Battery is very low
	Battery is charging		
	Location service turned on		Using location service
	Speaker phone tuned on		Headset with MIC connected
	Vibrate mode		Phone mic is mute

Status & Notifications Icons

Learning the basics



Notification icons

	Missed call		New SMS or MMS message
	New Email		Connected to VPN network
	Upcoming event		Alarm is set
	App update available		App updated
	Screenshot captured		
	Preparing SD card		SD card removed, unexpectedly
	OTG device connected		
	File uploaded		File downloaded
	File copied		
	Scanner turned on		USB connect mode selection
	There are more notifications		Other input method available

Set a Lock screen

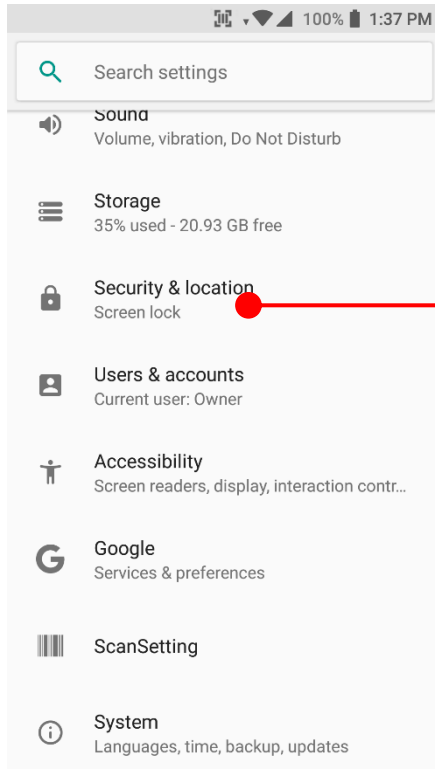
Learning the basics



Touch  **App drawer icon** →  **Settings** and then **Security & location**

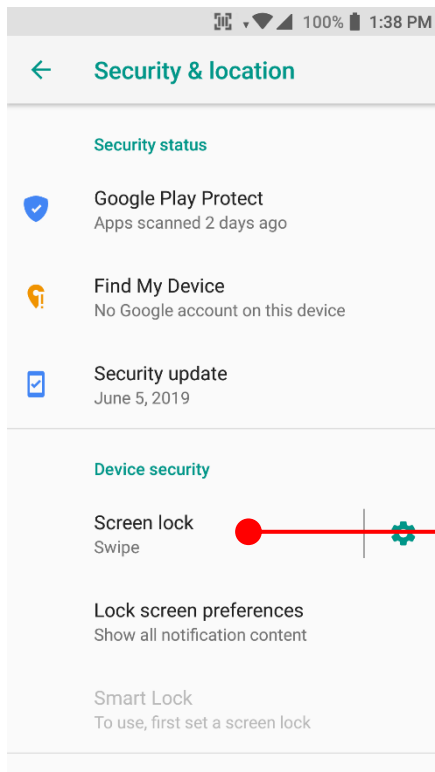

Touch **Screen lock**

You can see Screen lock type which is currently set. To change the screen lock, please touch the menu.

Set a Lock screen

Learning the basics

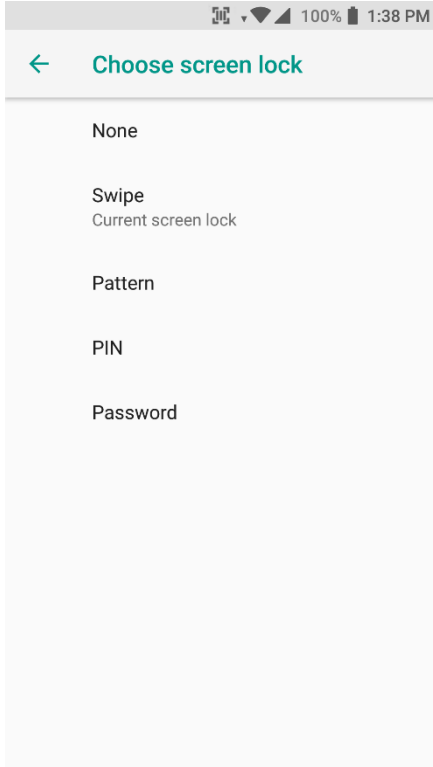

- None : PM90 screen unlock immediately
- Swipe : To unlock the screen, user should swipe the screen
- Pattern : To unlock the screen, user draw the pattern
- PIN : To unlock the screen, user should input the pin
(Numbers. At least 4 digits)
- Password : To unlock the screen, user should input the password
(Numbers & Alphabet combination. At least 4 characters)



Secure start-up

You can further protect this device by requiring your pattern before it starts up. Until the device starts up, it can't receive calls, messages, or notifications, including alarms.

This helps protect data on lost or stolen devices. Require pattern to start your device?

When you choose the Pattern, PIN or Password option, you can set **Secure start-up** option. This function enables user's unlock the PM85 before starts up

NO

YES

If you don't want Secure start-up option, please touch **NO**

Manage a display

Learning the basics

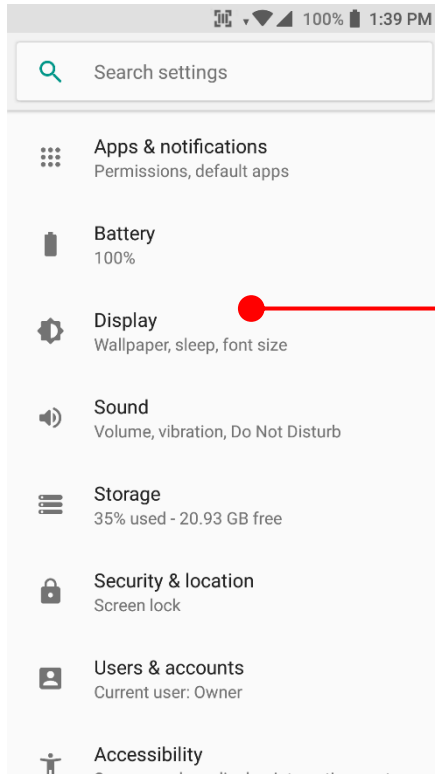

Touch **Display**



App drawer icon →



Settings and then

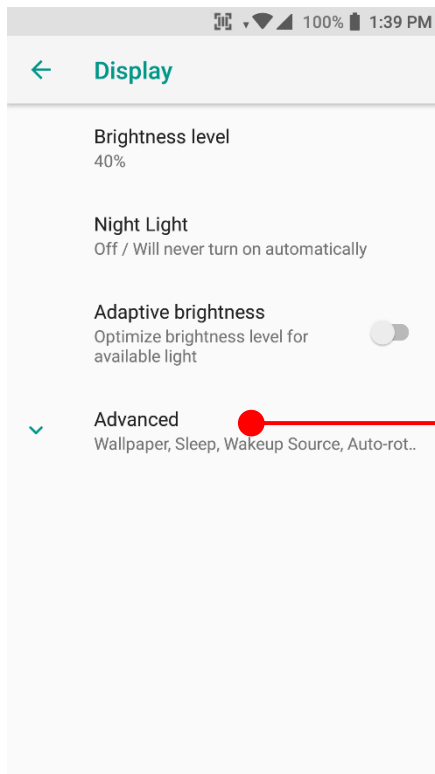

Touch **Advanced**

Brightness level : This setting changes the screen brightness level

Night Light : Set amber screen of PM85

Adaptive brightness : By enable this option, PM85 adjust the screen brightness

Manage a display

Learning the basics

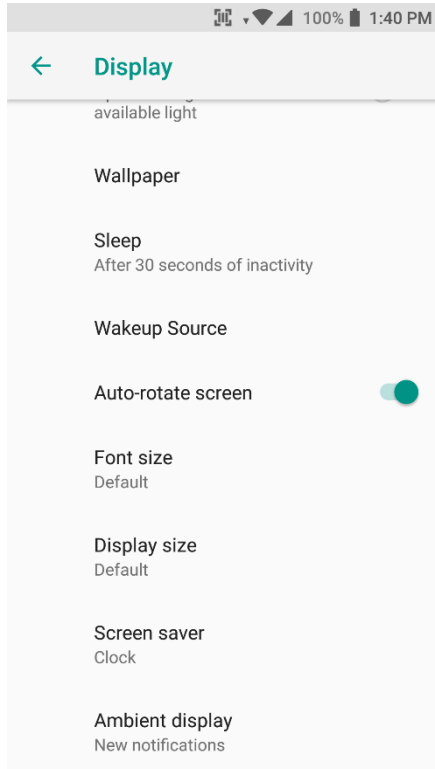

Brightness Level

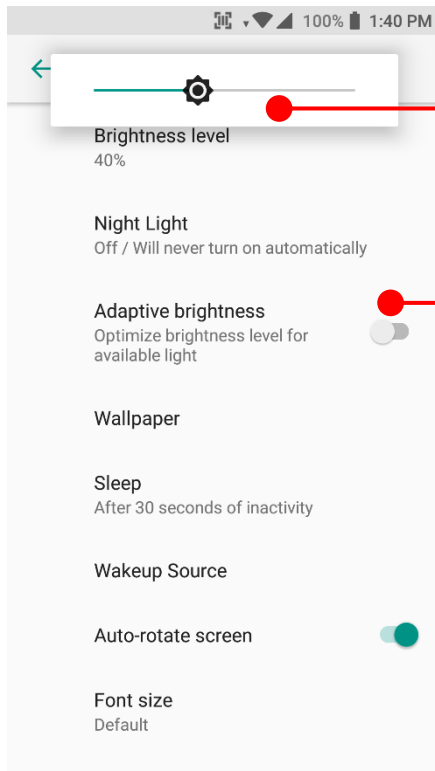

To change the brightness level, please adjust the slider

If you let PM85 auto adjust the brightness level, please touch "Auto" or enable "Adaptive brightness" option

Manage a display

Learning the basics

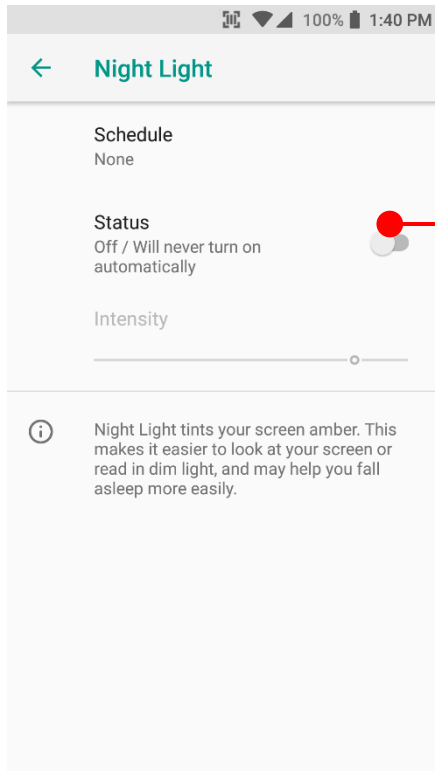

Night Light

To apply amber light, touch here to enable the option

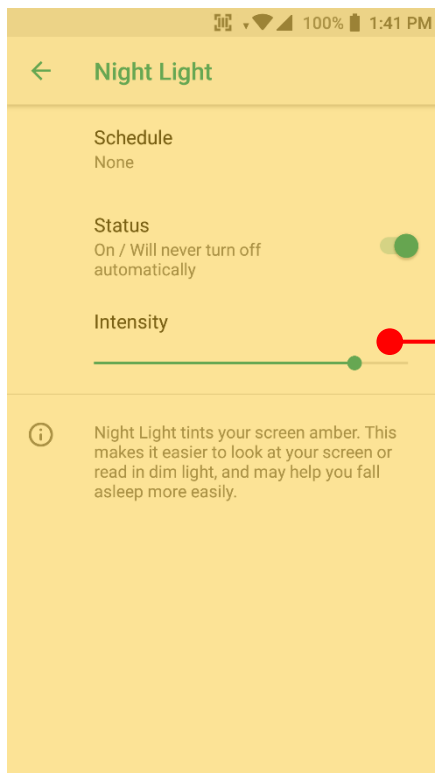

To change the amber level, please adjust the slider

Manage a display

Learning the basics



Font size

Change the overall font size of PM85. Please adjust the slider

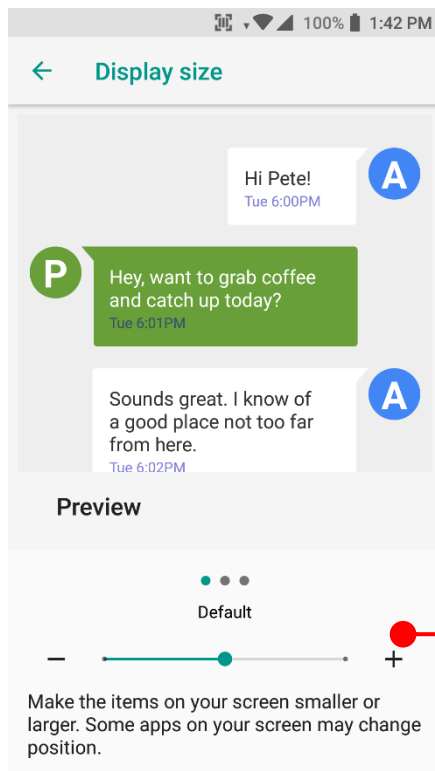

Display size

Change the amount of the display item of PM85. Please adjust the slider

Manage a display

Learning the basics

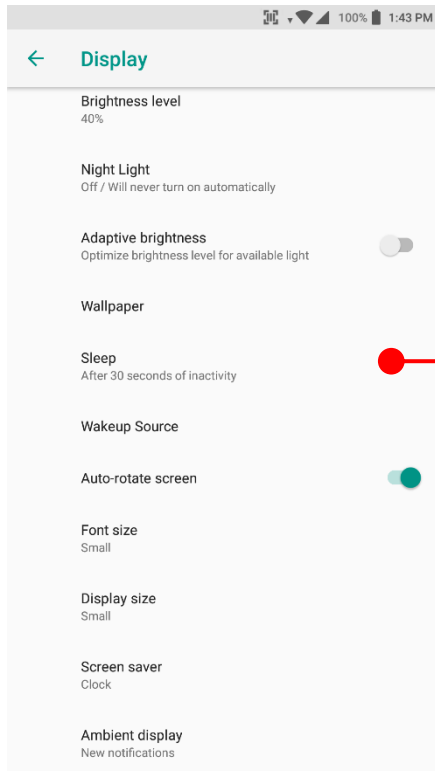

Touch to change PM85's display sleep time

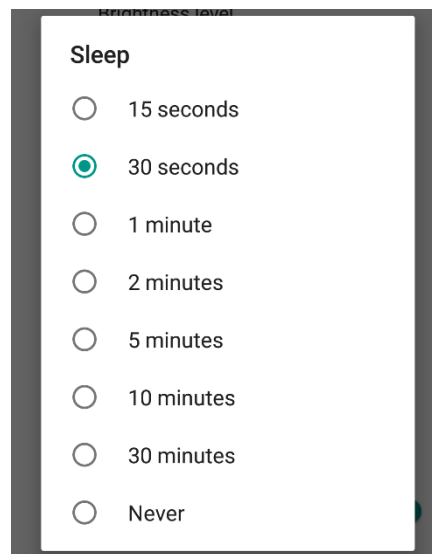

Make a call

Learning the basics

The screenshot shows the Phone app interface. At the top, there is a search bar for contacts and places. Below it are three tabs: Favorites, Recents, and Contacts. The Contacts tab is selected. Underneath, there is a list of contacts, with the first one being 'Point Mobile' with the number '02-3397-7870'. Below the contact list is a numeric keypad with letters associated with each number. At the bottom, there is a green call button.

Touch drawer **App drawer** icon and then icon in the app drawer

You haven't added any favorites yet

[Add a favorite](#)

Touch to use a dialer

Touch to access the Favorites, Recents and Contacts.

- To make a call from recent call list or missed call, select **Recents** tab
- To make a call from your contact list, select **Contacts**

Suggested phone number(s)

CONTACTS save options

Touch to place a call

Make a call

Learning the basics

The image shows two parts of an Android phone's calling interface. The top part is a 'Calling...' screen for the number 070-7090-2689 from South Korea. It features a yellow profile icon, the number, and the country. Below this are three control buttons: 'Mute' (microphone icon), 'Keypad' (dial pad icon), and 'Speaker' (speaker icon). A red line points from the 'Calling information' label to the number and country. Another red line points from the 'Speaker' button to a list of instructions. Below these buttons is an 'Add call' button with a plus sign icon. A red circle with a white telephone handset icon is shown with a red line pointing to the text 'Touch to end a call'. The bottom part of the image shows an incoming call notification for the same number. It has a 'Phone' dropdown menu, the number, and the text 'Incoming call'. Below the notification are two buttons: 'DECLINE' (red text) and 'ANSWER' (green text). A red line points from the 'Caller information' label to the number and country. Another red line points from the 'Answer' button to a list of instructions. At the bottom of the phone screen, there are icons for Google, EmKit, and Play Store, and a dock with icons for Phone, Messages, App Drawer, Chrome, and Camera.

Calling information

- Mute : Touch to mute the mic
- Keypad : Touch to input keypad during a call
- Speaker : Touch to make a speakerphone call

Touch to end a call

Caller information

- Decline : Touch to refuse a call
- Answer : Touch to answer a call

Tip: To mute the ringtone volume of an incoming call, press the Volume down or Volume up key

Add to a contact

Learning the basics

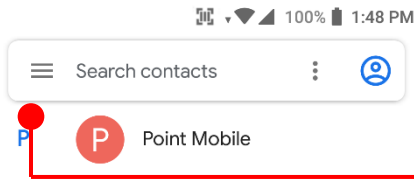

Touch  icon in the Favorite tray apps

Touch to see Contacts options



Touch to add a new contact

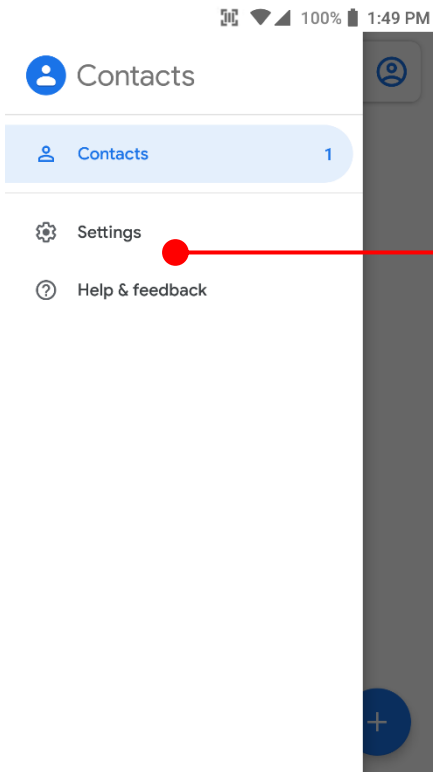

Touch to set more detail settings

Add to a contact

Learning the basics

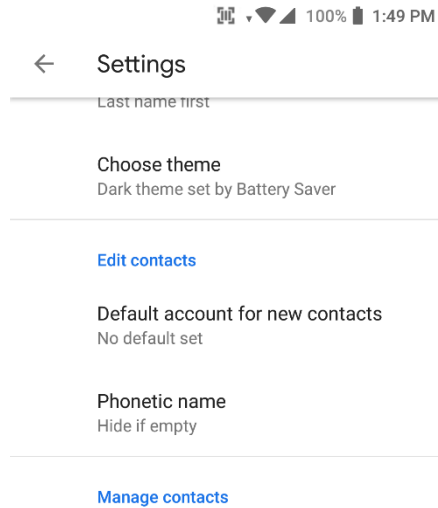

Touch to import contact information in your SIM card

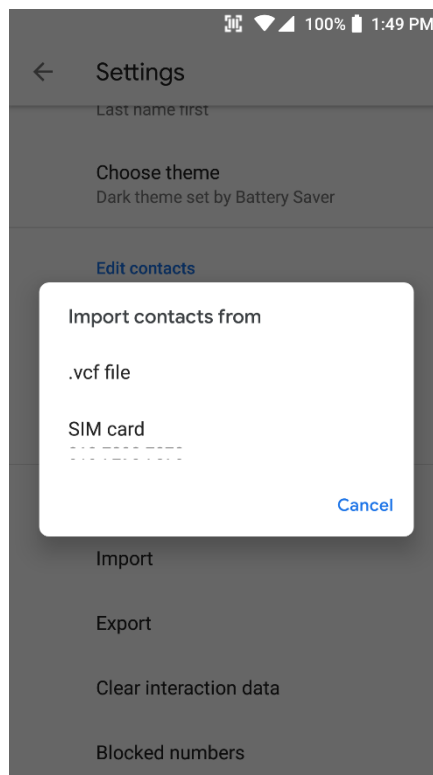

Add to a contact

Learning the basics

Touch to save the contact

Input Contact name, phone numbers and other information in the form

Touch to see advanced options

Touch to edit contact information

Add to a contact

Learning the basics

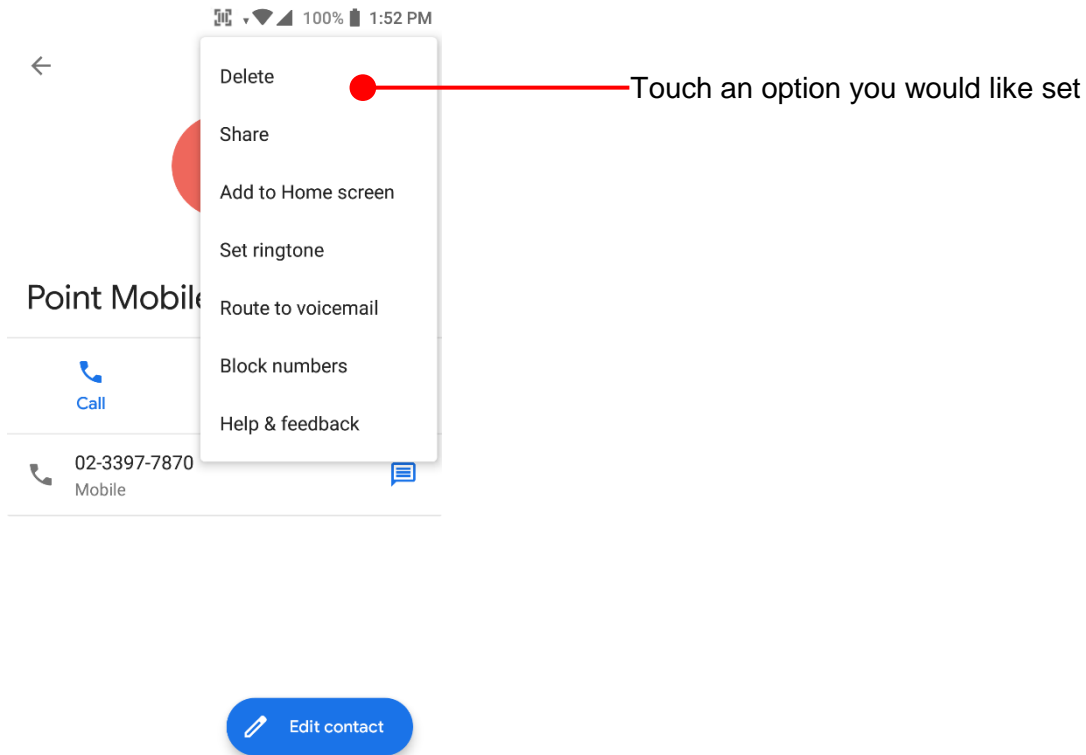

Send a message

Learning the basics

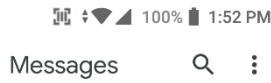

Touch  icon in the Favorite tray apps



Once you start a new conversation, you'll see it listed here

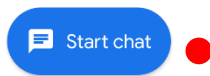

Touch to start a new message

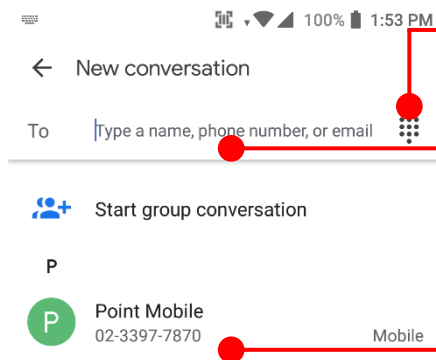

Touch to use a dialer

Touch to type a name, phone number or email

Saved contact lists in the PM85

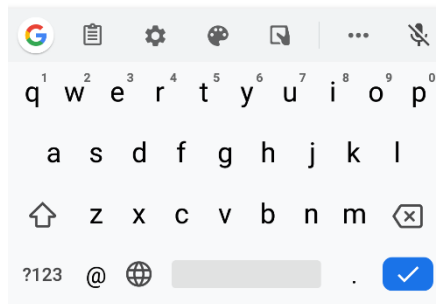

Send a message

Learning the basics

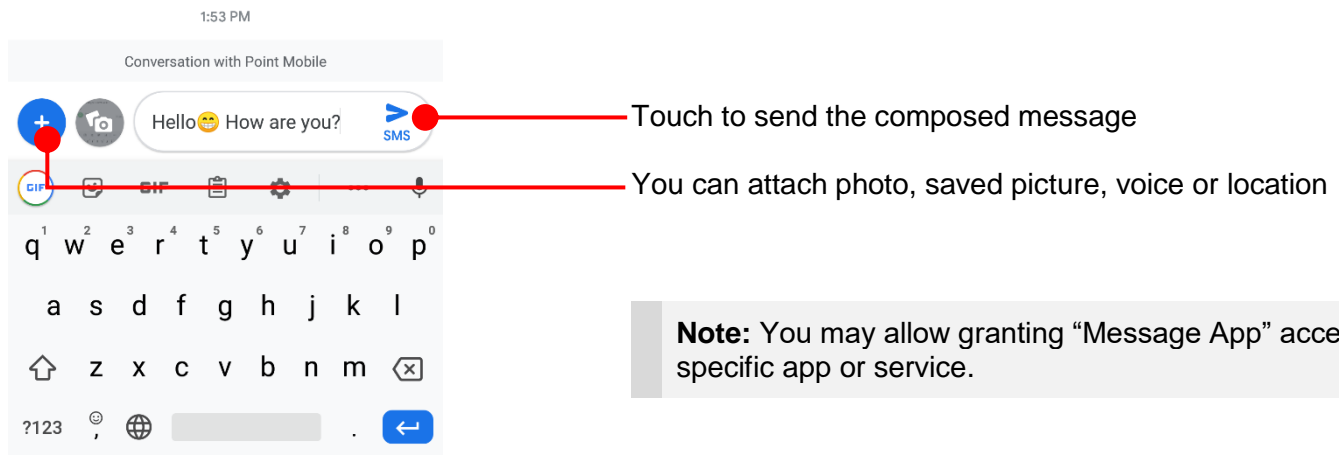
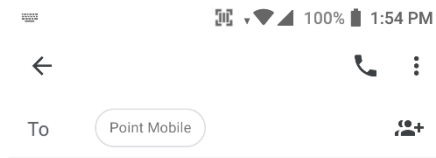
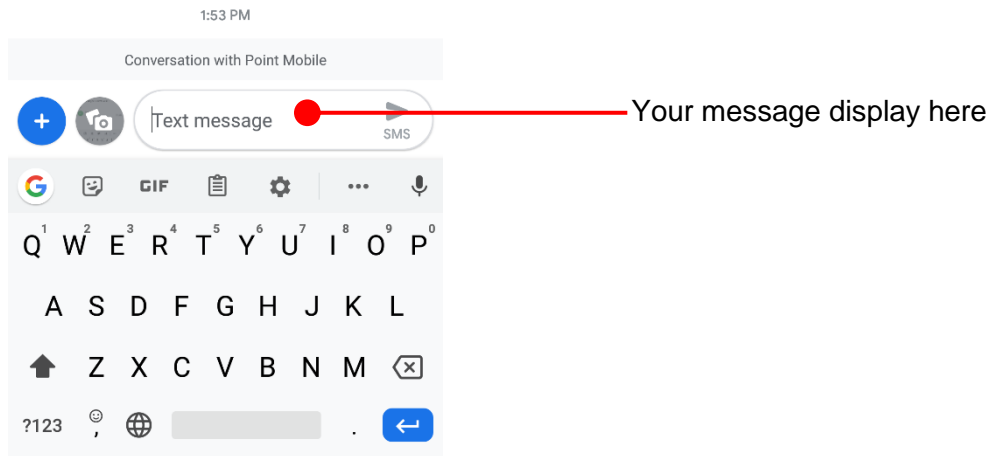
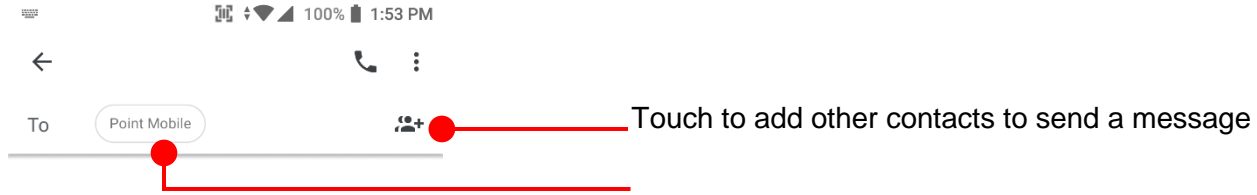

Note: You may allow granting “Message App” access specific app or service.

Send a message

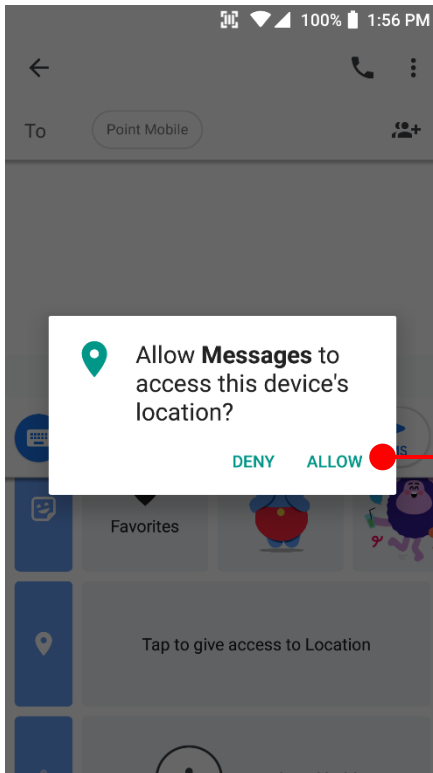

Learning the basics

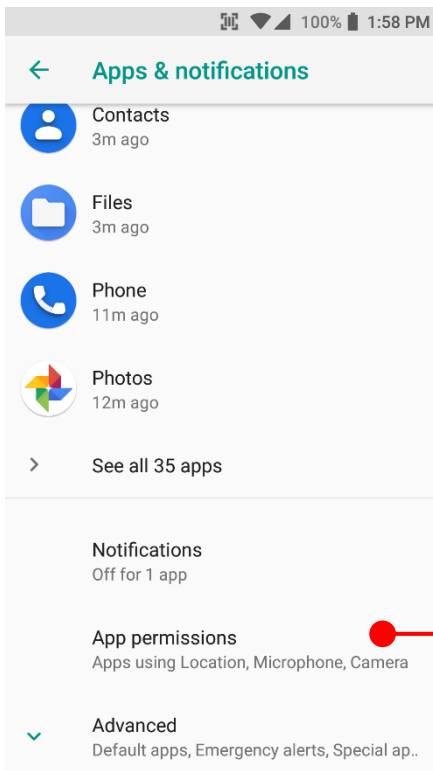

Android ask a grant app's specific permission access for first time use. To send a photo or a saved media file or a voice recode file or a location, please touch **ALLOW**



Note: You can review granted permission info at

Touch  **App drawer icon** →  **Settings** and then **Apps & notifications**

Change a SIM card settings

Learning the basics

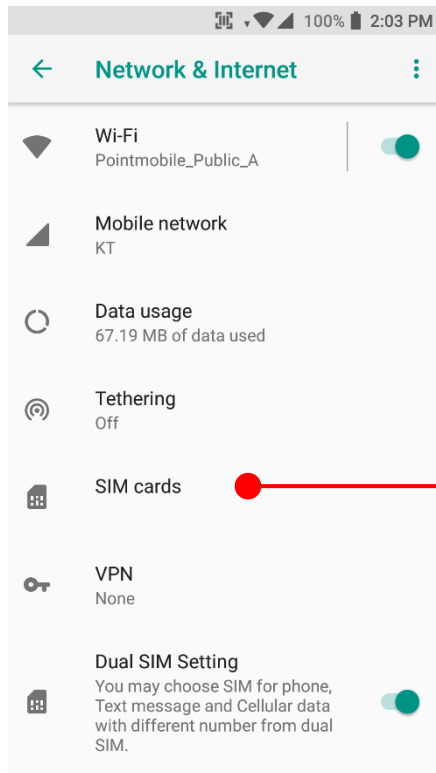

Touch  **App drawer icon** →  **Settings** → **Network & Internet** and then **SIM card**

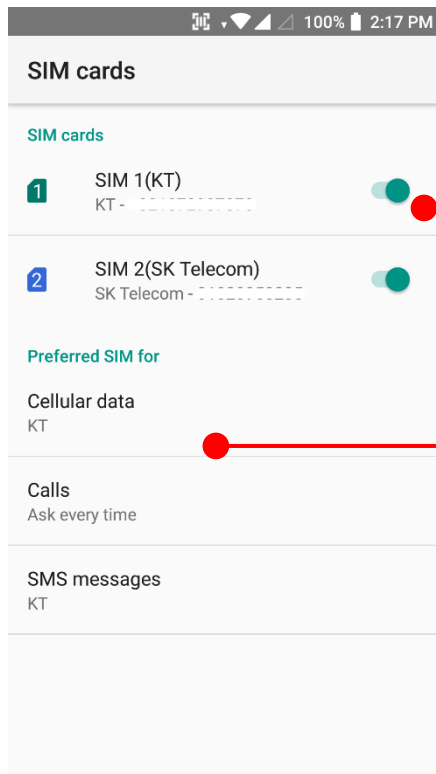

Touch to enable/disable the SIM card

Currently set option for data, call and message
Touch to change each option

Note: PM85 is Dual SIM Dual Standby model. Both of SIM make a call, use a data and send a message. But one SIM is on a call, incoming calls on another SIM will go to voicemail.

Change a SIM card settings

Learning the basics

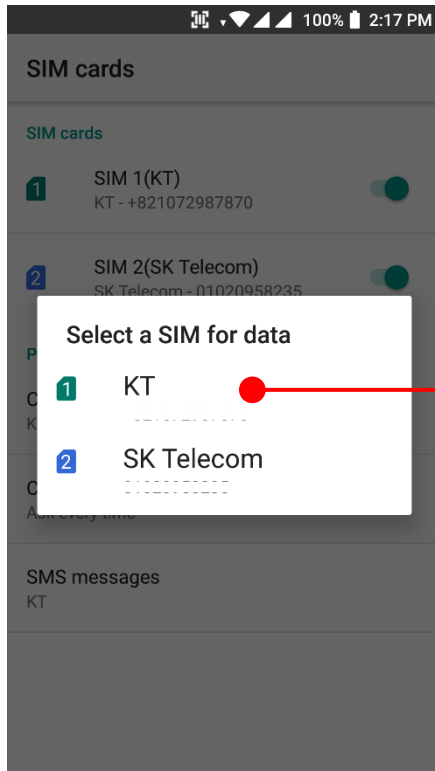

Select SIM card for mobile data
Both SIM card make a data connection. This option sets primary SIM card

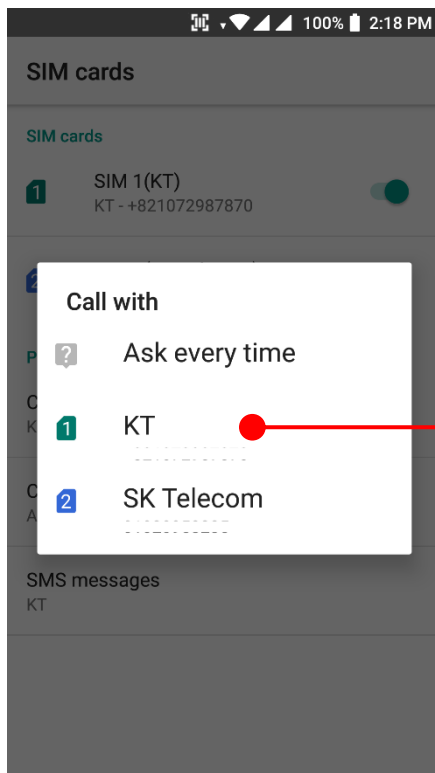

Select primary SIM card for calling.
Both SIM cards make a call. This option sets primary SIM for phone call

Change a SIM card settings

Learning the basics

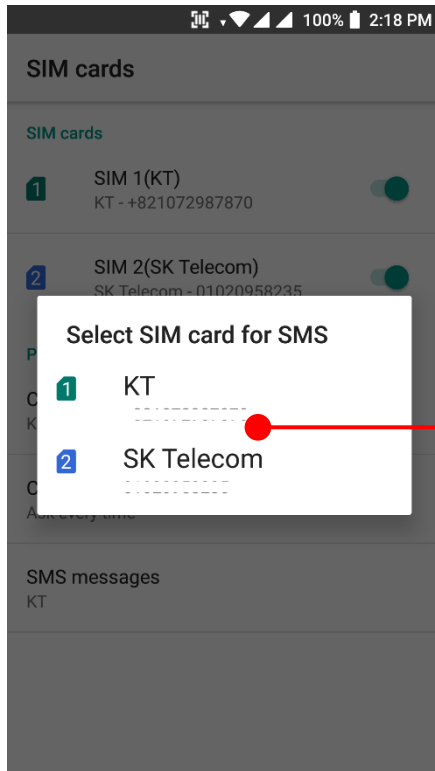

Select primary SIM card for messaging.
Both SIM cards send and receive a message. This option sets primary SIM for message

Connect to your Wi-Fi network

Learning the basics

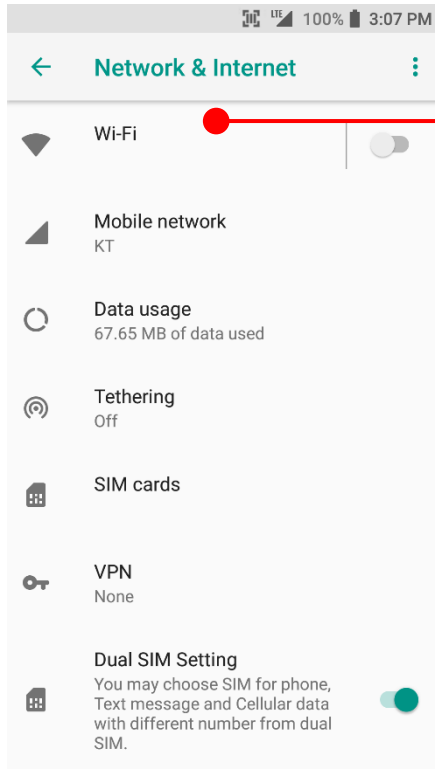

Touch  **App drawer icon** →  **Settings** → **Network & Internet** and then **Wi-Fi**

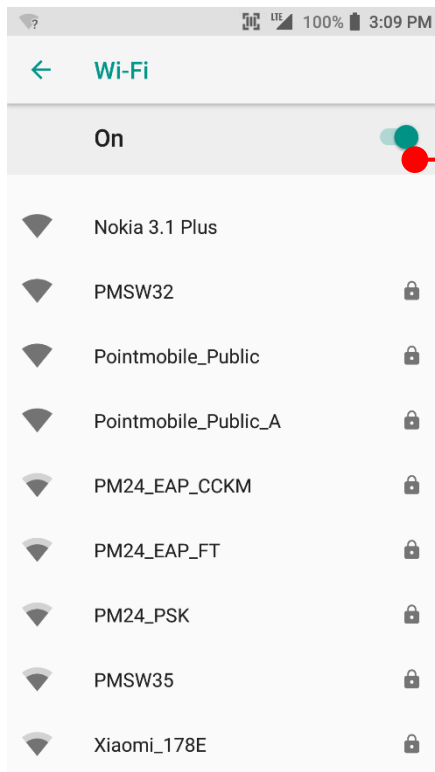

Touch to turn On/Off the W-Fi

You can see nearby Wi-Fi network. Each AP's SSID information listed by signal strength

 Icon means: Secured Wi-Fi network. To connect this Wi-Fi, you need to enter the password

Connect to your Wi-Fi network

Learning the basics

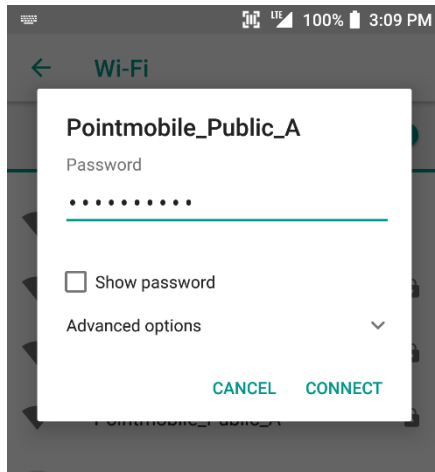

Touch SSID, which you want to connect.
To connect to the secured Wi-Fi network, enter the password

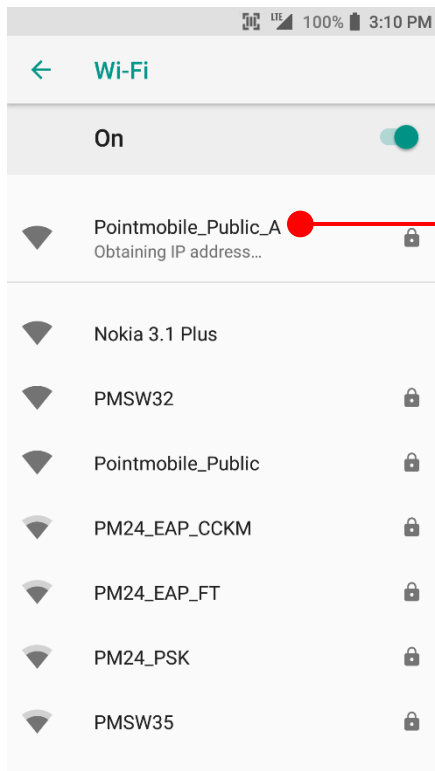
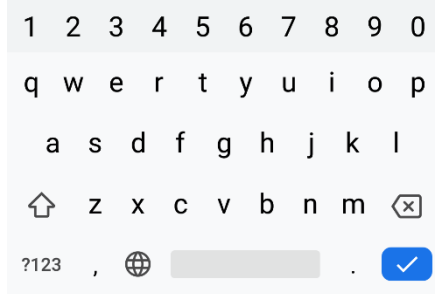

PM85 is obtaining the IP address from the selected AP

Make a Wi-Fi hotspot

Learning the basics

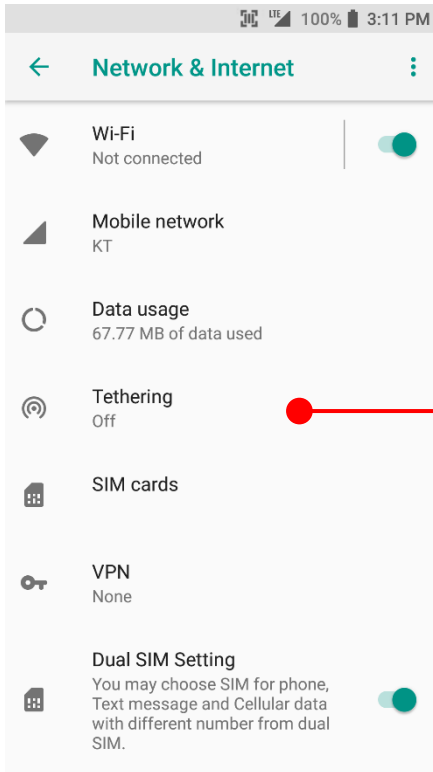

Touch  **App drawer icon** →  **Settings** → **Network & Internet** and then **Tethering**

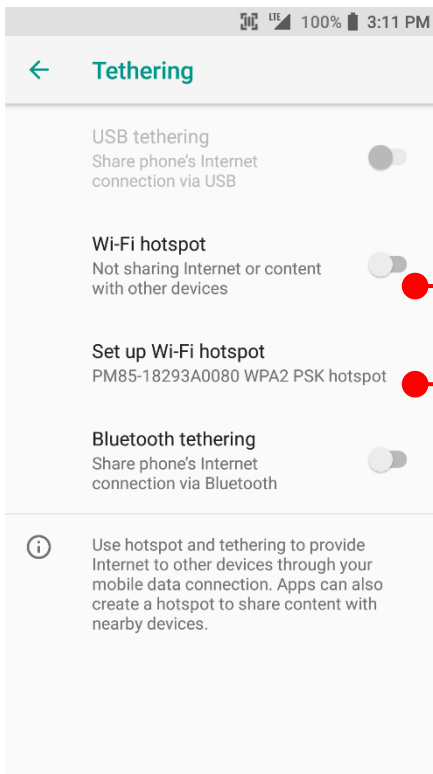

Touch to turn On/Off the W-Fi hotspot

Touch to set Wi-Fi hotspot setting

Make a Wi-Fi hotspot

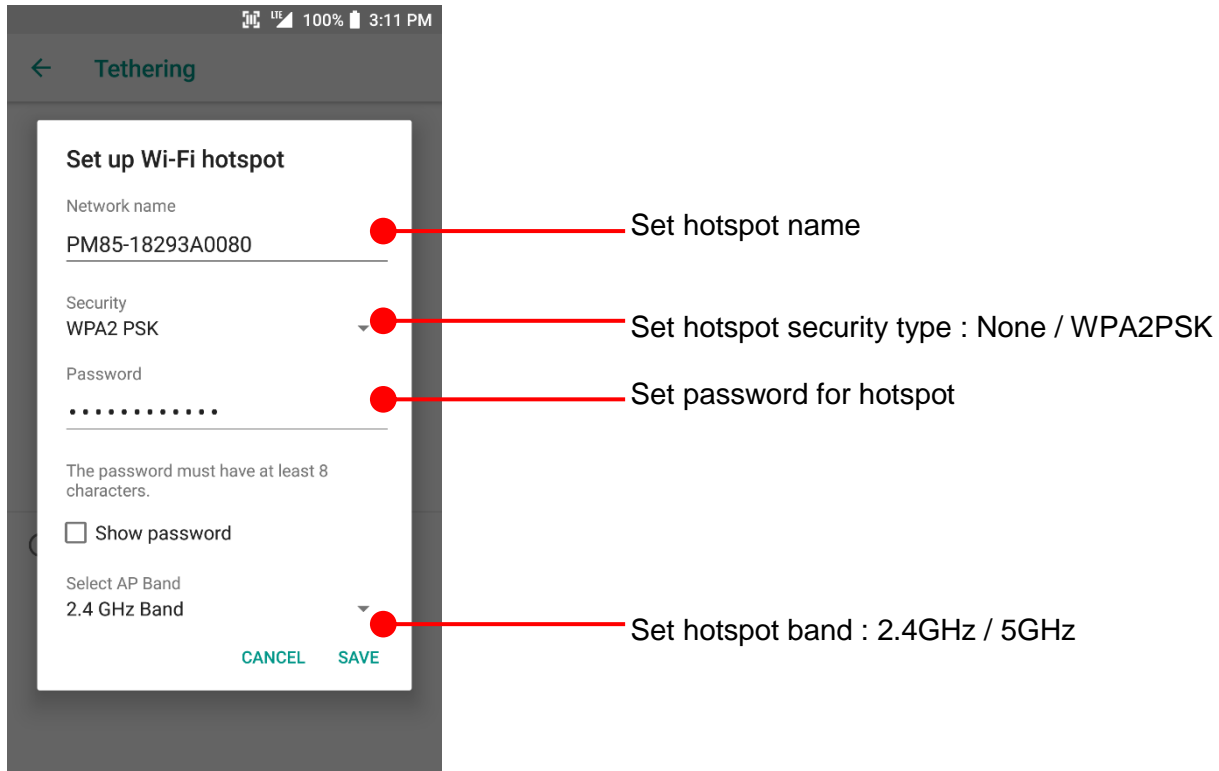

Learning the basics

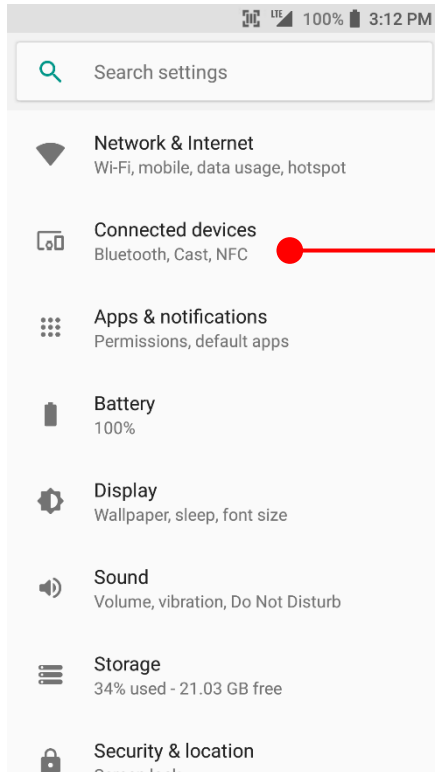

Connect with Bluetooth device

Learning the basics



Touch  **App drawer icon** →  **Settings** and then **Connected devices**

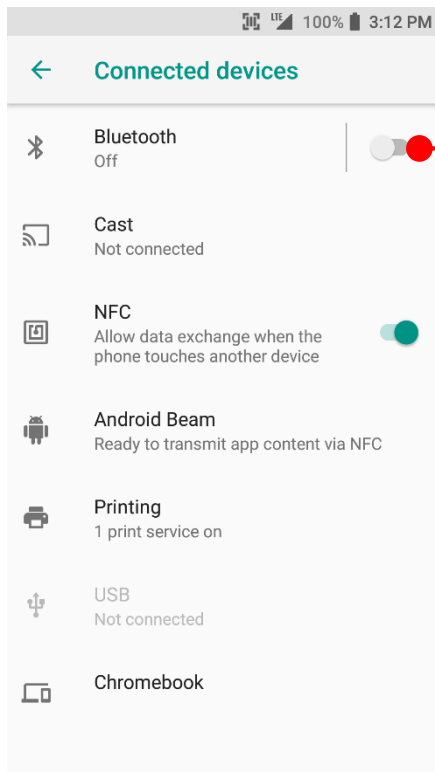

Touch to turn On/Off the Bluetooth

Connect with Bluetooth device

Learning the basics

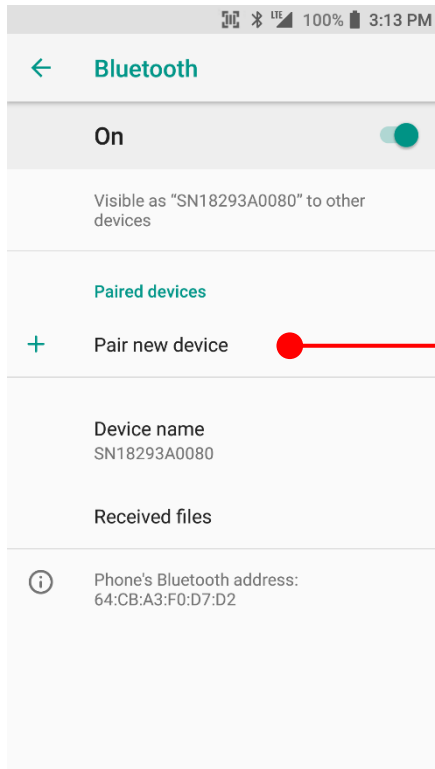

Touch to make a Bluetooth pairing with nearby Bluetooth device

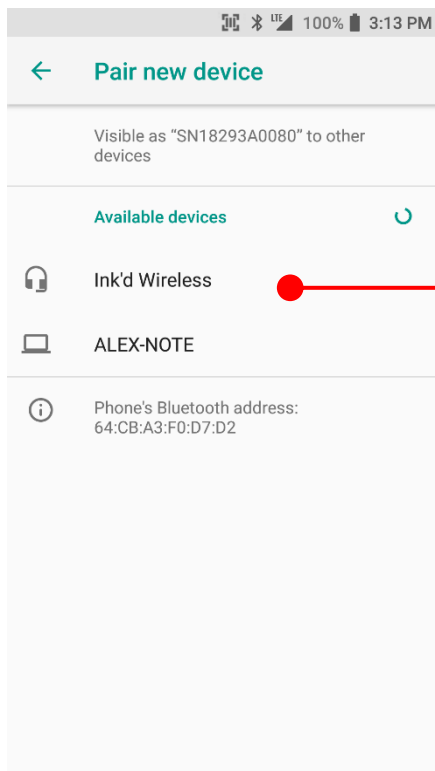

PM85 will list up nearby Bluetooth devices. Touch to make a pairing. (You may input the password)

Connect with Bluetooth device

Learning the basics

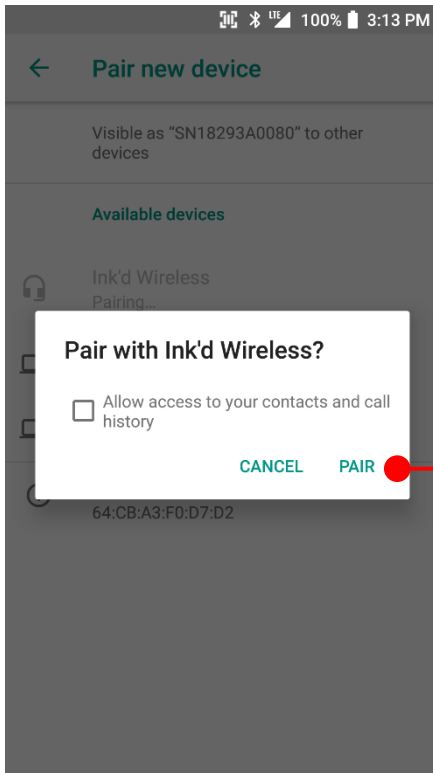

Touch **PAIR** button

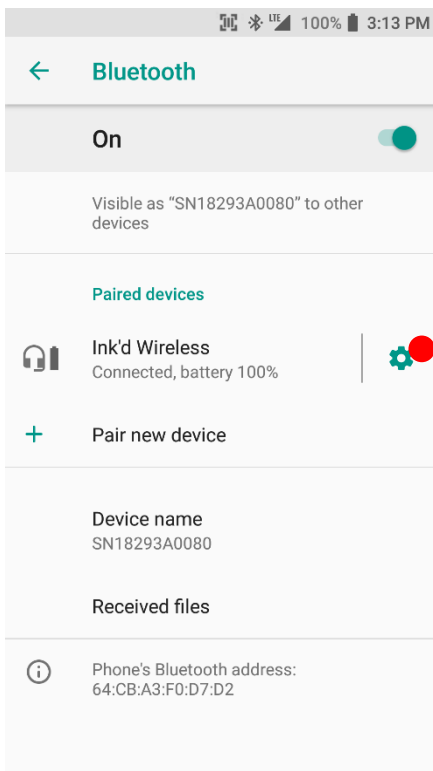

Bluetooth device is connected with PM85.
Touch ⚙ icon for advanced setup

Use a Camera

Learning the basics

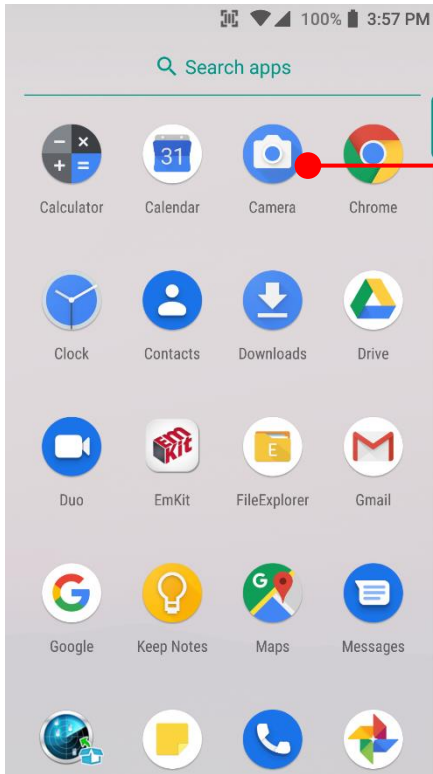

Touch icon in the favorite tray or Touch icon and then →



App drawer



“Camera” icon

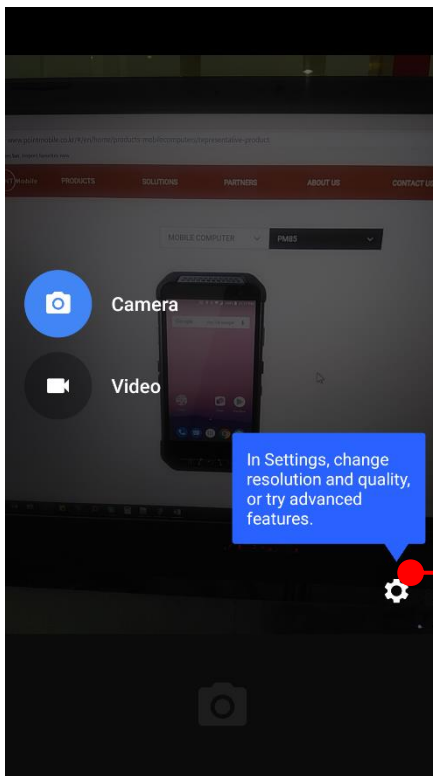

Touch for advanced setting

Use a Camera

Learning the basics

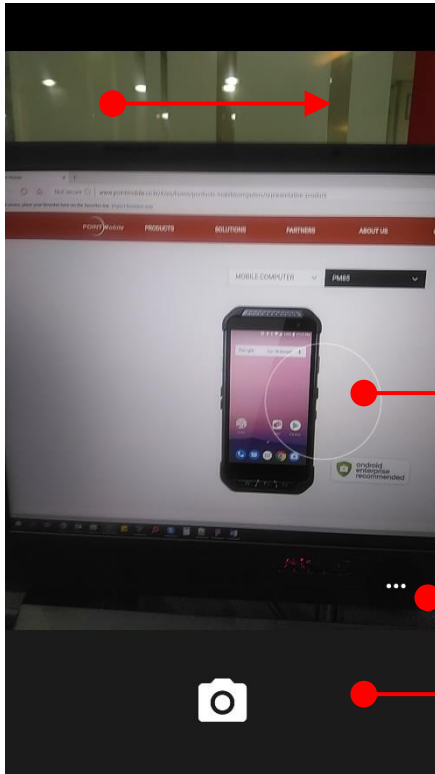

Swipe to change the Camera / Video mode or access to Settings

Auto focused area

Touch for Camera / Video option

Touch to take a picture or recode a video

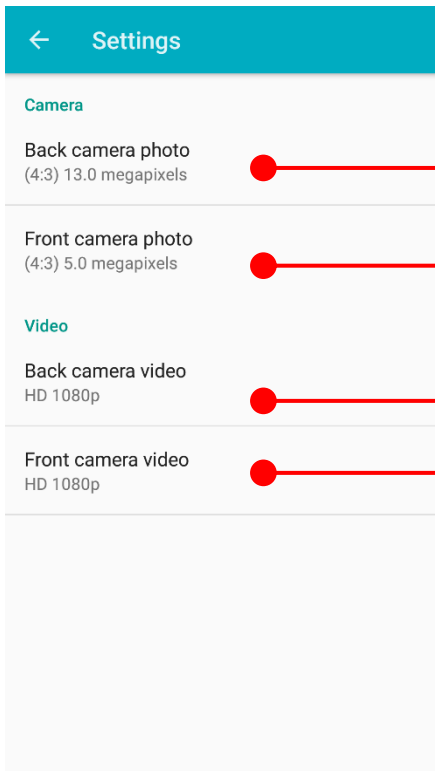

Set rear camera image saving quality

Set front camera image saving quality



Set rear camera video saving quality

Set front camera video saving quality

Manage files and folders

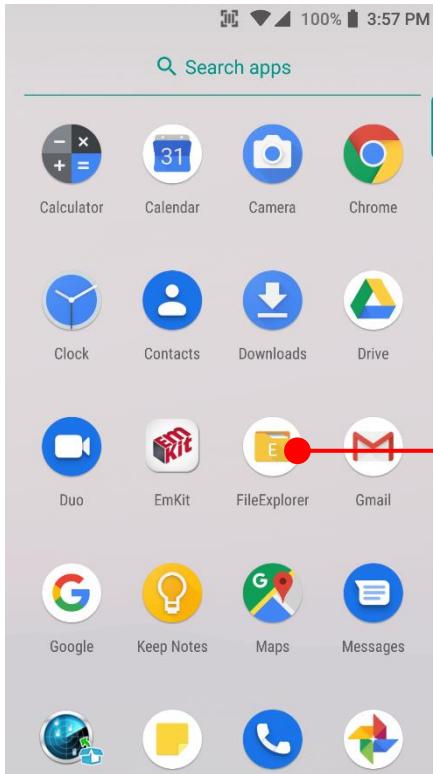
Learning the basics



Touch  "App drawer" icon and then  "File Manager"

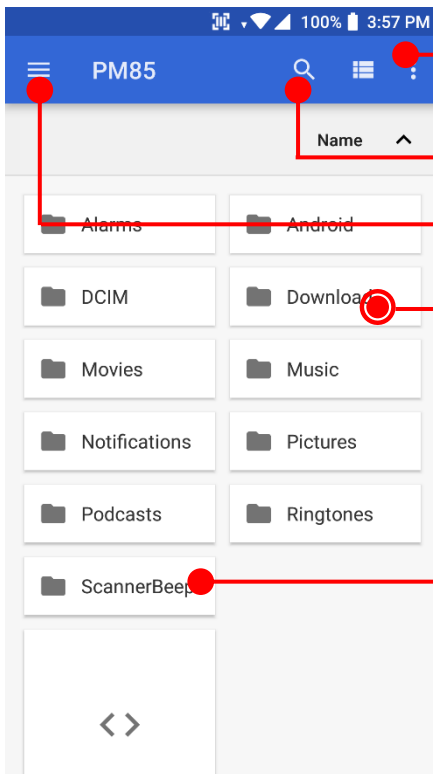

Touch for advanced menu

File search

Select storage

Long tap to select a file or folder

Touch to navigate folder / open the file or install an apk file

Manage files and folders

Learning the basics

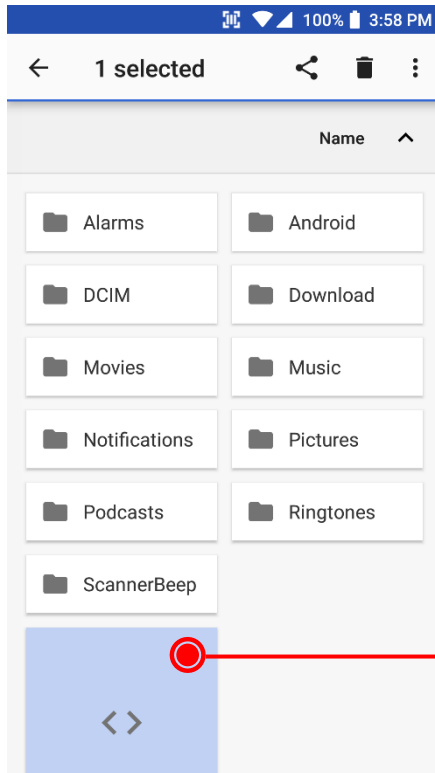

Long tap the file and touch option icon  in top-left corner

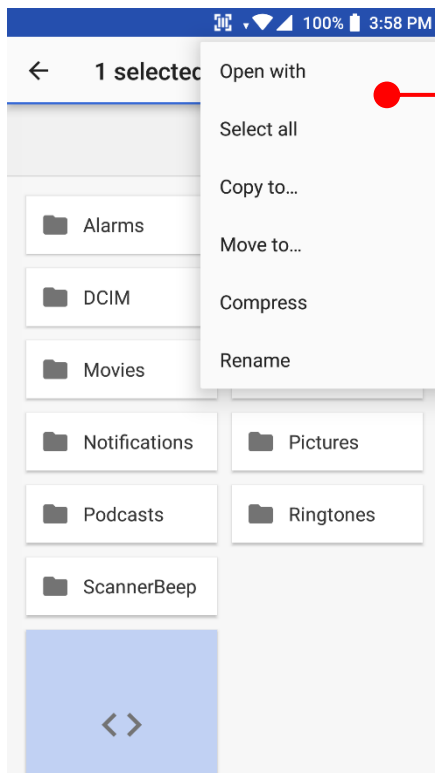

Now you can copy the file, move to specific folder or rename the file or folder

Manage files and folders

Learning the basics

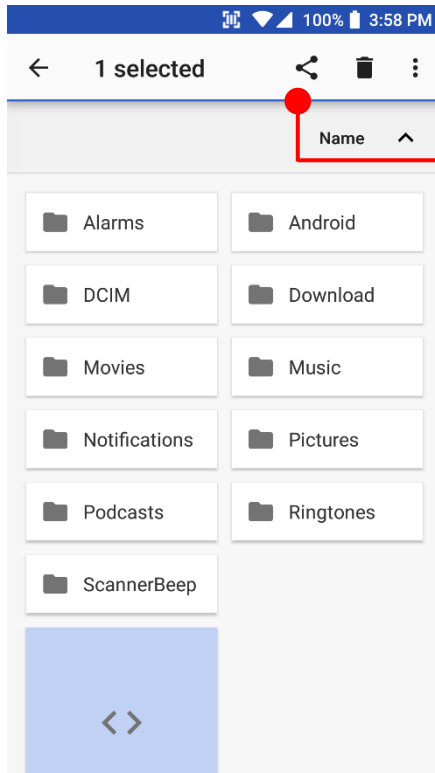

Share a file

Long tap the file and touch share icon  in the menu

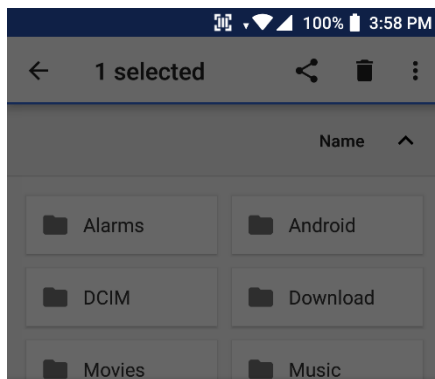

Share via



Now you can share selected file to nearby device or attach to Gmail or upload to Google Drive. Manual describe Android Beam sharing via NFC

Manage files and folders

Learning the basics

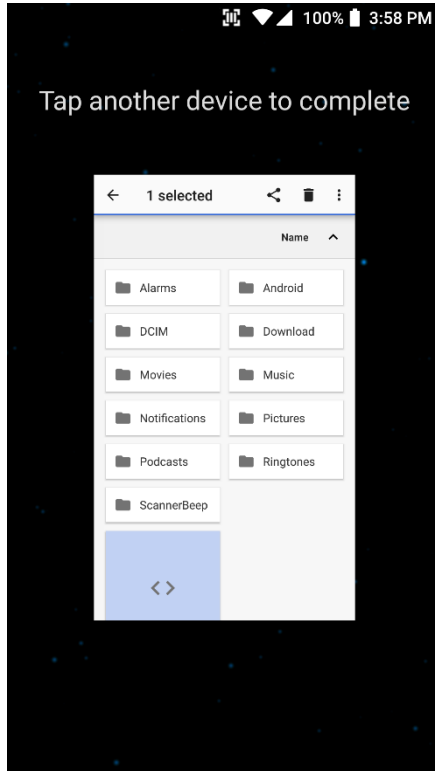

Now tag another device to PM85
PM85 will transfer the file

Manage files and folders

Learning the basics

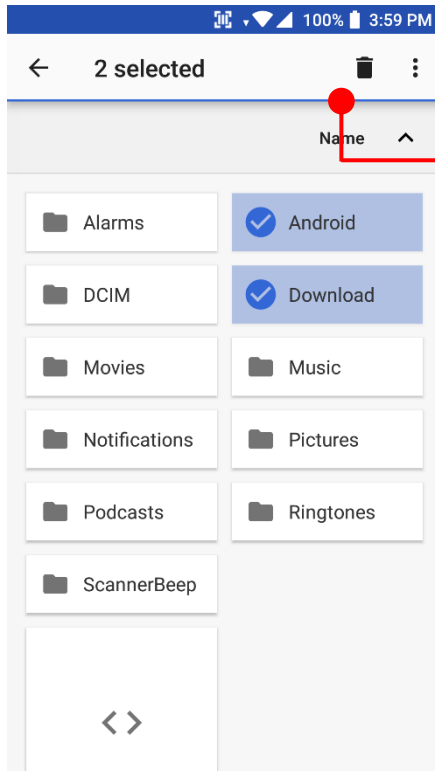

Delete files

Long tap the file and touch delete icon  in the menu

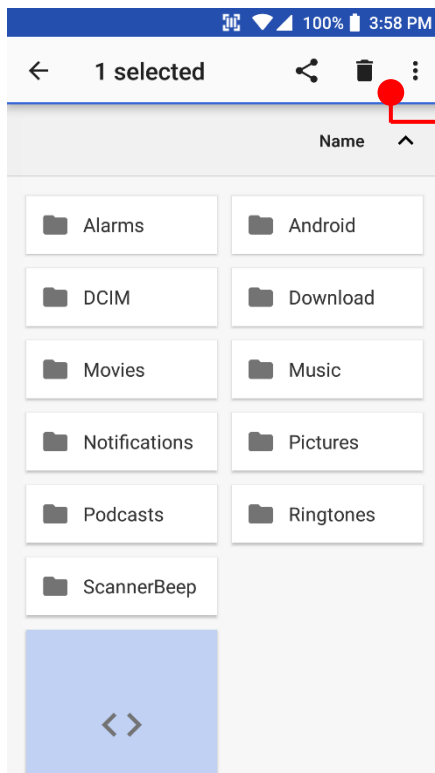

Copy or move files

Long tap the file and touch option icon  in top-left corner

Manage files and folders

Learning the basics

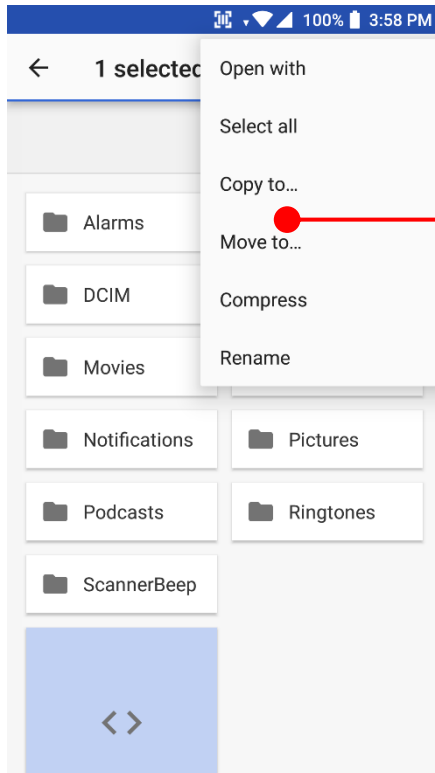

Touch **Copy to...** or **Move to...** in the menu

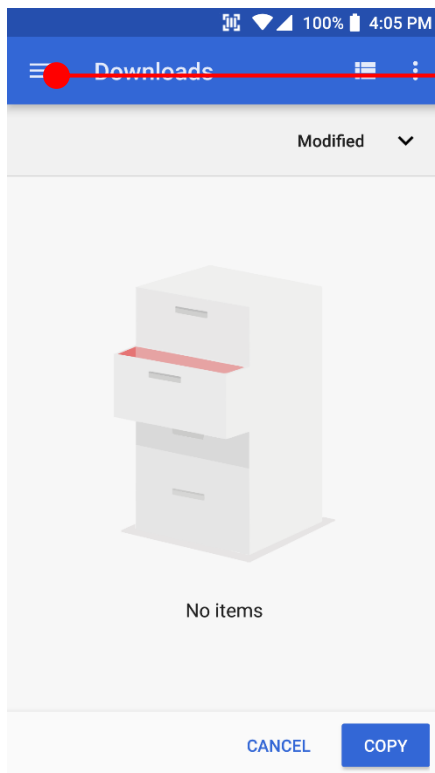

Touch menu icon ≡ to navigate file location

Manage files and folders

Learning the basics

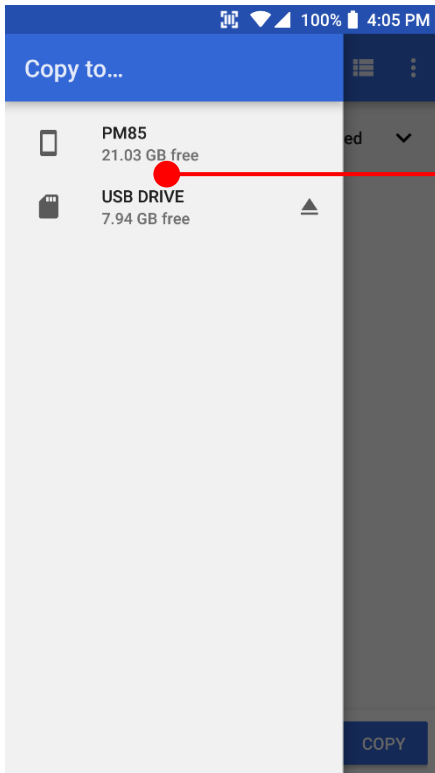

Touch the storage where copy or move to

Note: Please format the SD card as FAT32 and make sure set the label as below screenshot from the computer

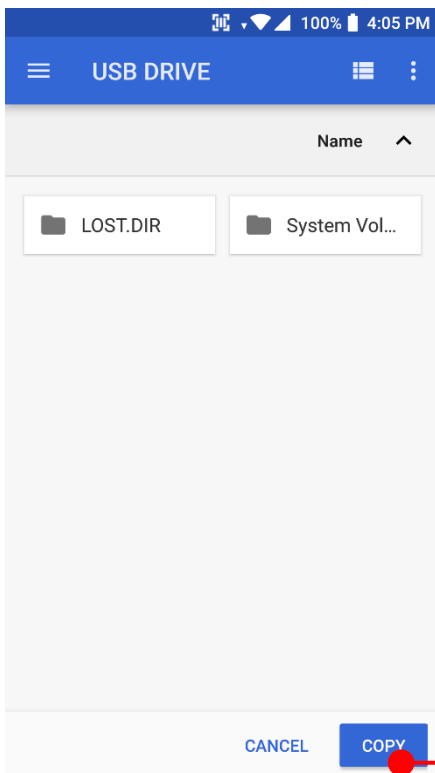
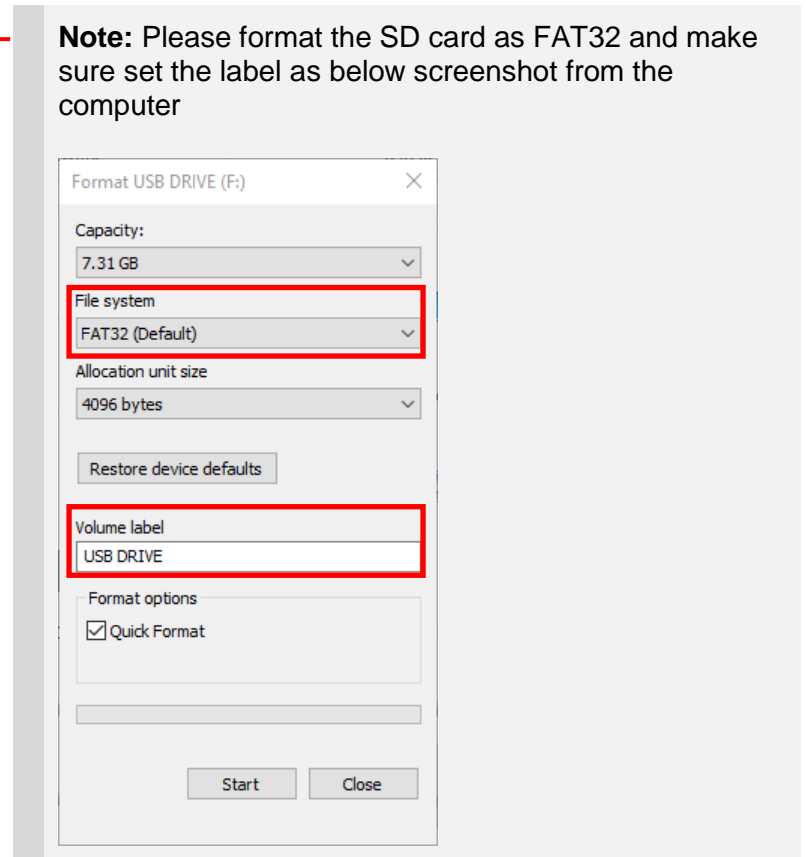

Touch **COPY**

MTP connection with PC

Learning the basics

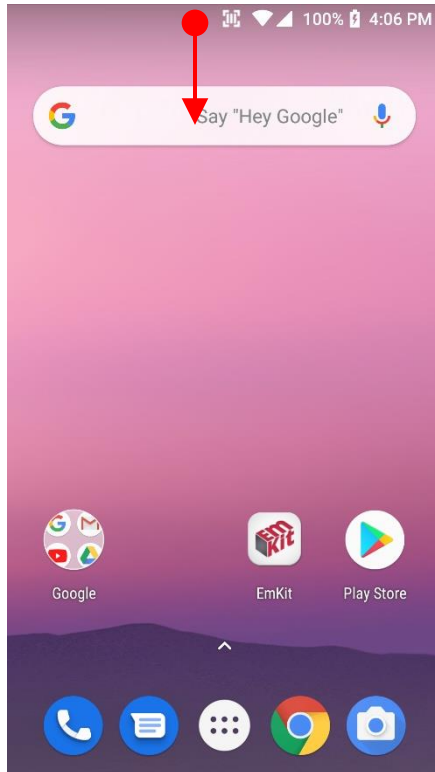

To browse files and folder in the PM85 in your PC, please change USB connect option

Scroll down the notification panel

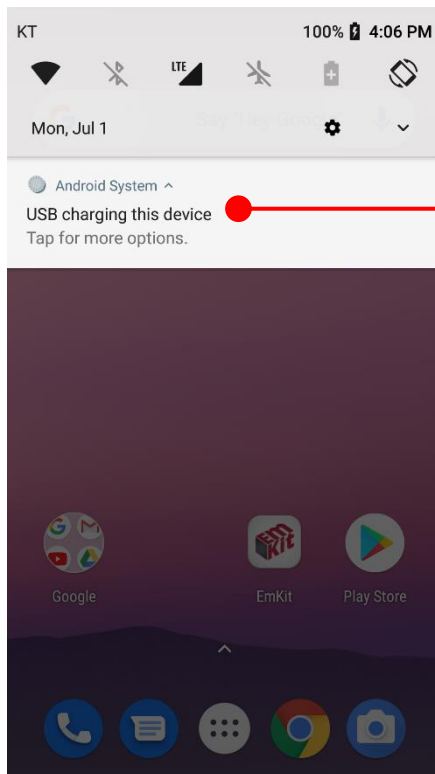

Touch USB connect option

MTP connection with PC

Learning the basics

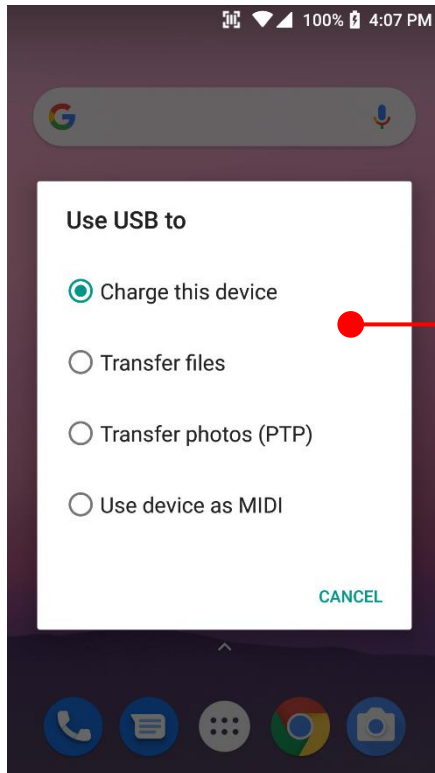

Change option to **Transfer files** from **Charge this device**

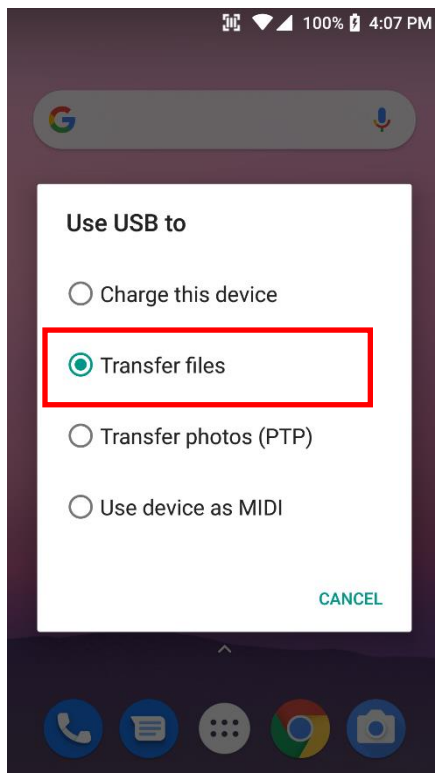

Now your PC recognize PM85 as MTP device

MTP connection with PC

Learning the basics

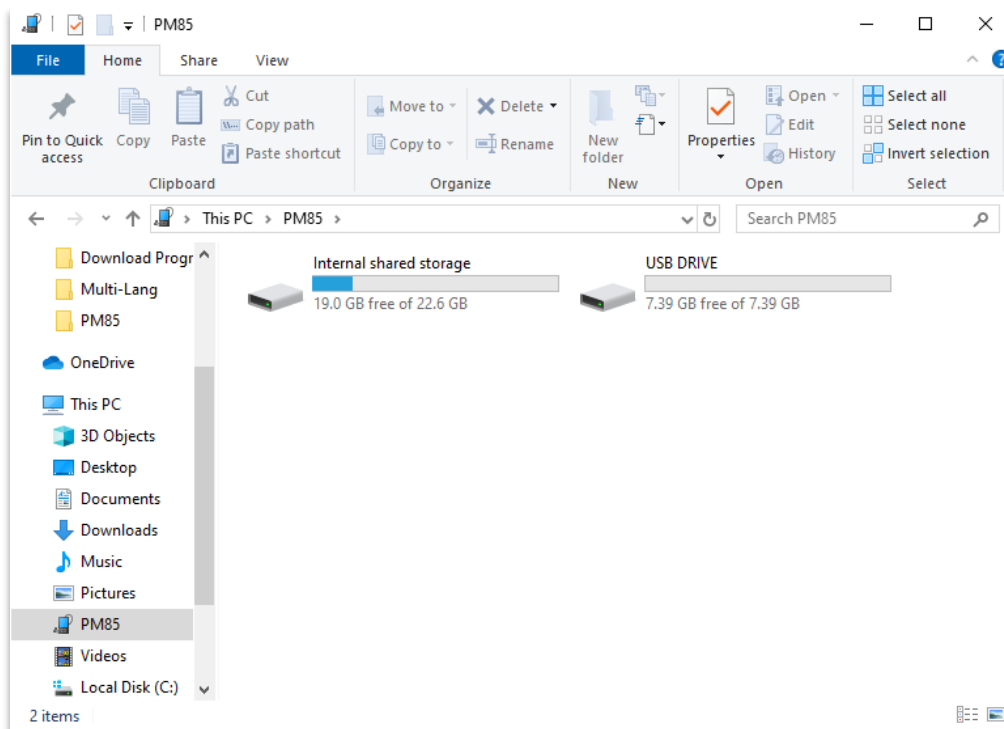
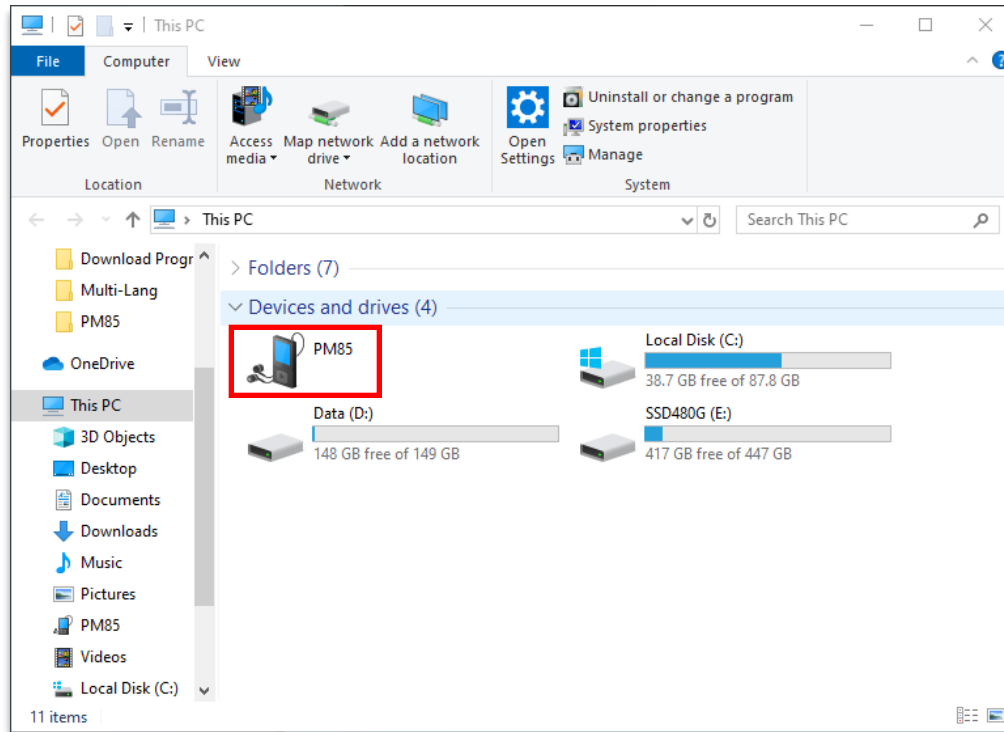

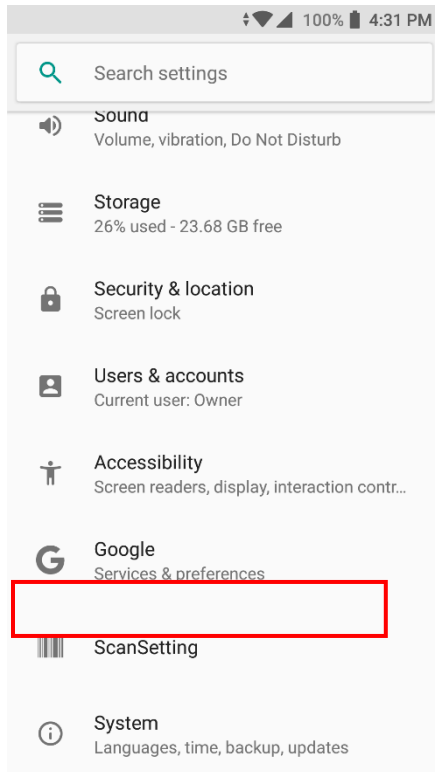

Use a Scanner

Scanner Settings



Default setting of Scanner is **Off**
To use the Scanner,

- Touch  EmKit and then **ScanSetting**
- Touch  **App drawer icon** →  **Settings** and then **ScanSettings**

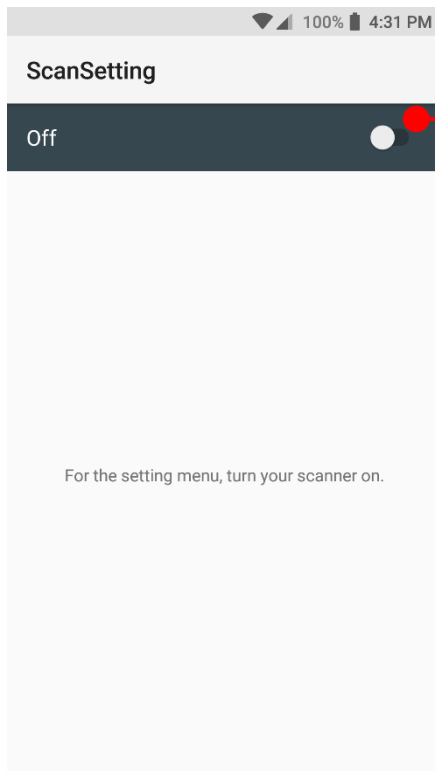

Touch to turn on the Scanner

Use a Scanner

Scanner Settings

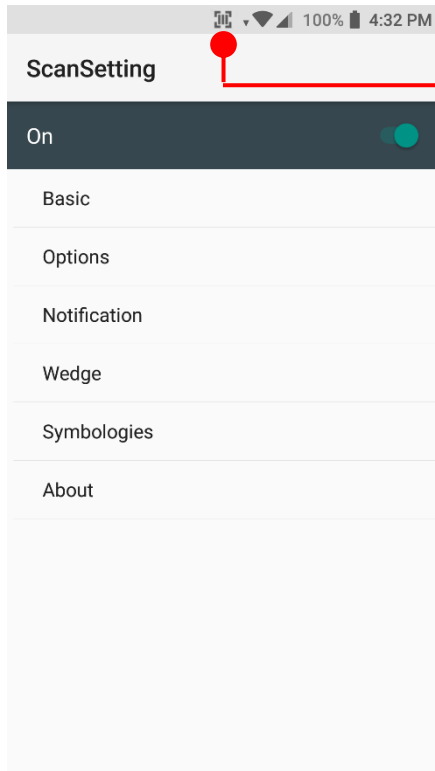

Now you can see **Scanner Wedge** icon in the **Status Bar**

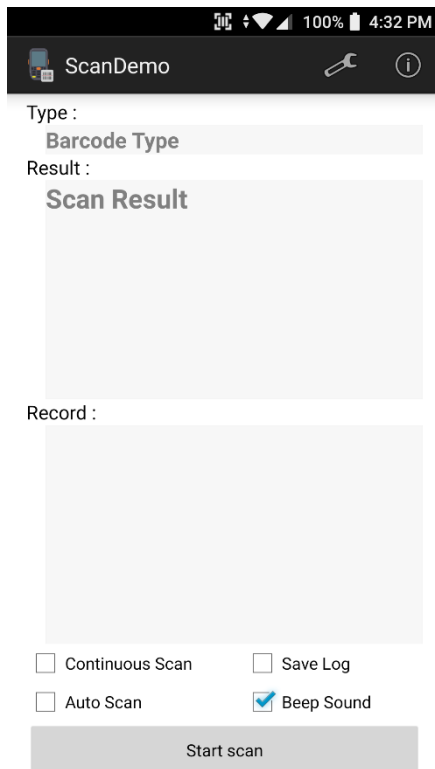

Note: When “Scanner” turned on, you can scan the barcode with **ScanDemo** in the **EmKit**

Use a Scanner

Scanner Settings

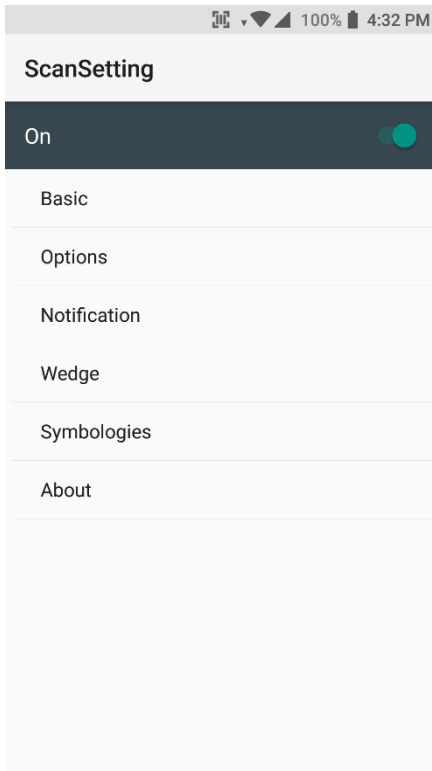

Scanner setting details

Scanner setting consist with **Basic**, **Options**, **Notification**, **Wedge**, **Symbologies**, and **About**

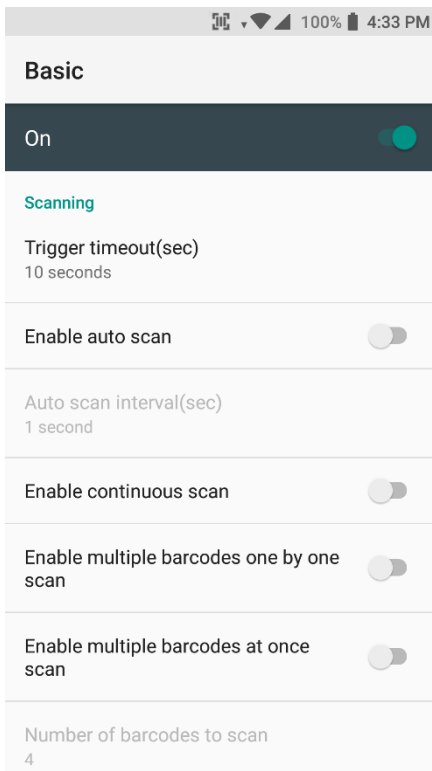

In the **Basic**, you can set **Scanning** option and **Wedge mode** option

In the **Scanning** option, you can change Scanner's **Trigger timeout** and set **Auto scan & Continues scan** options

Use a Scanner

Scanner Settings

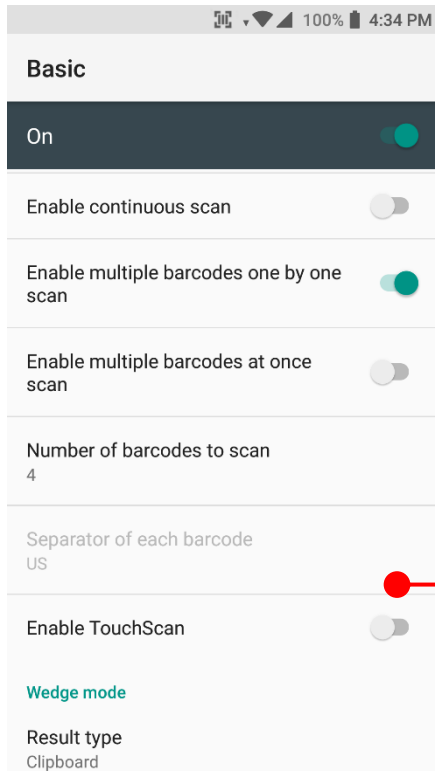

TouchScan is software scanner button. Touch to enable this function

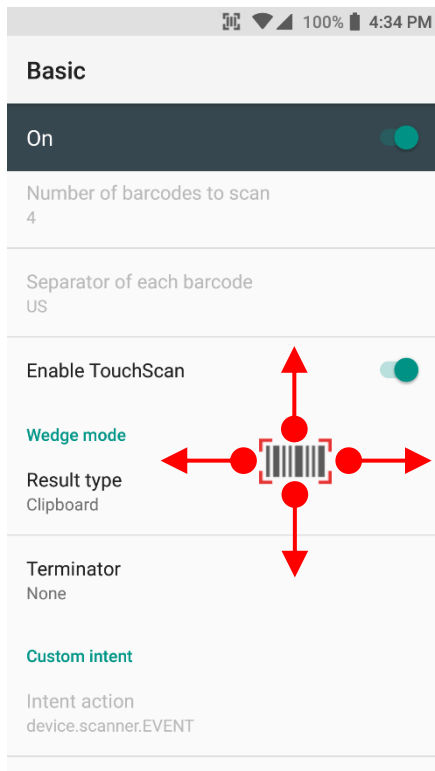

You can place **TouchScan** icon any position. Touch this icon to read the barcode.

Use a Scanner

Scanner Settings

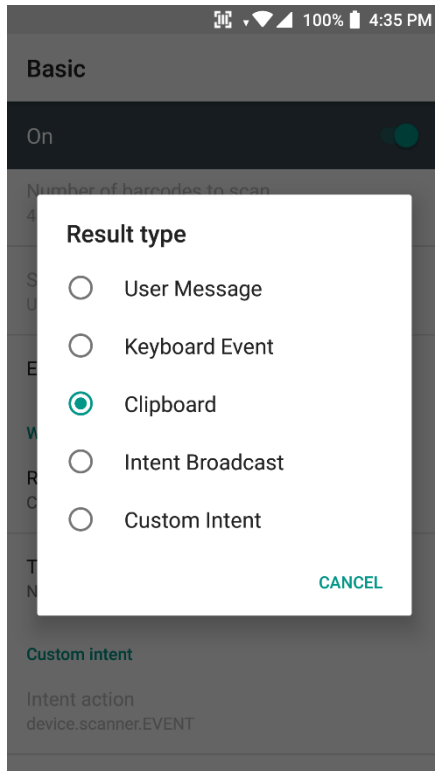

In the **Wedge menu** you can change, decode scan data's result type handling **User Message**, **Keyboard Event**, **Clipboard**, **Intent Broadcast** or **Custom Intent**

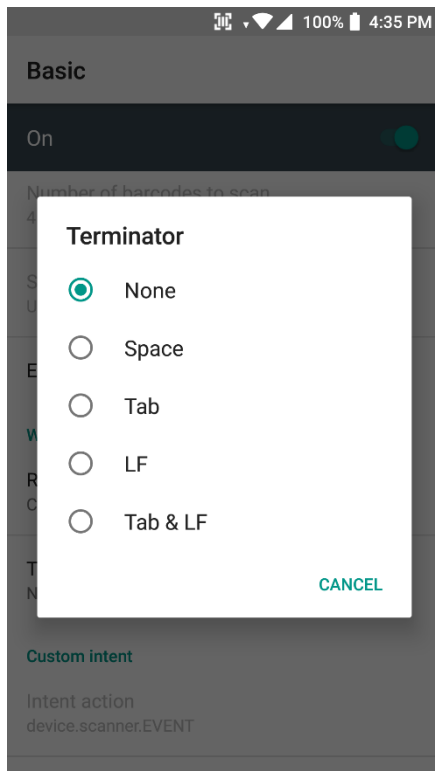

Also, you can set Terminator as **None**, **Space**, **Tab**, **LF** or **Tab & LF**

Use a Scanner

Scanner Settings

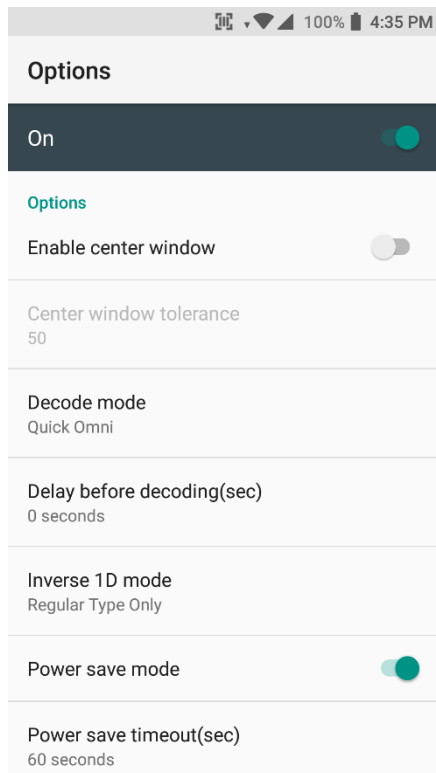

In the **Options**, you can enable/disable the **Center Window**, set **Decode mode**, **Power save mode** and enable/disable **Aimer & Illumination** option

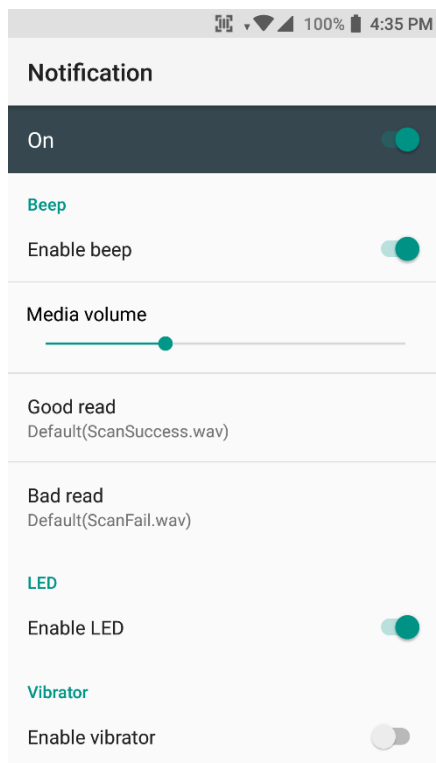

In the **Notification**, you can change the volume level, notification sound, LED and vibration option

Use a Scanner

Scanner Settings

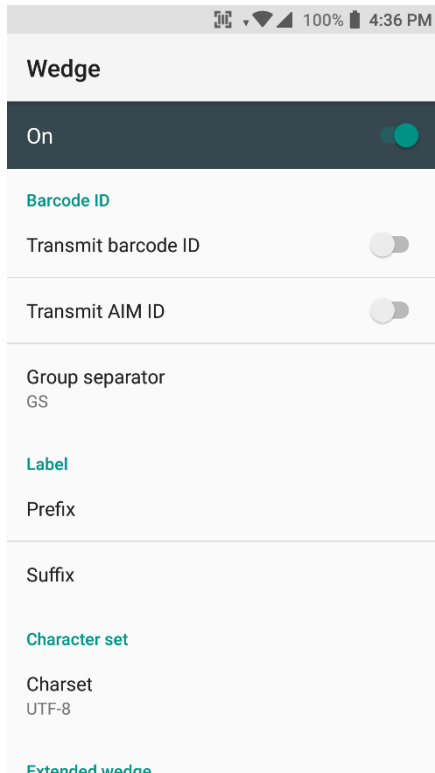

In the **Wedge**, you can enable/disable **Barcode ID** and **Aim ID**, set **Group separator**, **Prefix & Suffix**, **Character set** and **Extended Wedge**.

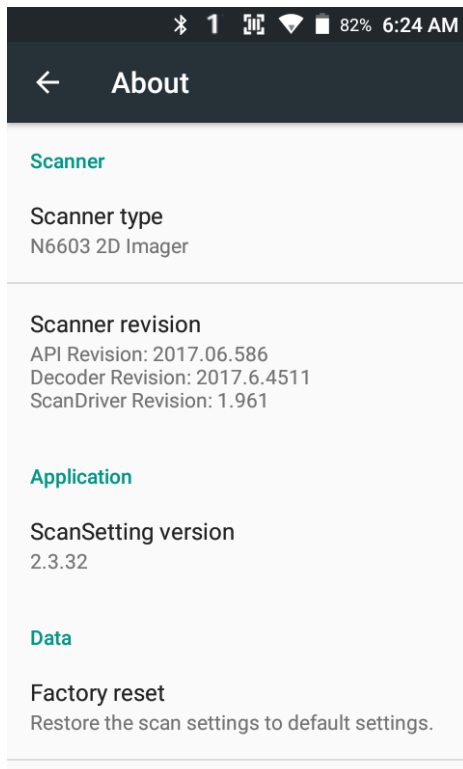

In the **About**, you can check your Scanner's information and restore Scanner's settings to default

Scan a Barcode

Scanner Settings

Example of good Barcode reading



Idle barcode scan
Please aim the middle of barcode



Even you aim the barcode slightly upper or down area or angle is slightly tilted, you can read the barcode



Scan a Barcode

Scanner Settings

Example of bad Barcode reading



If you aim the barcode wrong direction or tilt too much, you can't read the barcode



If you aim part of Barcode or aim two barcodes together, you can't read the barcode



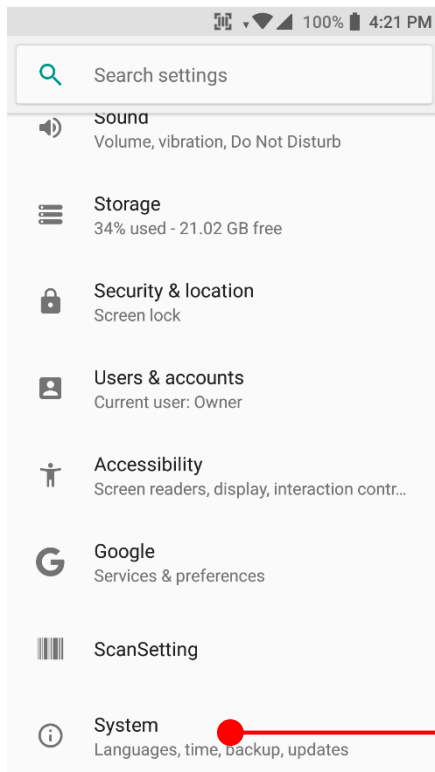

OS Image update from a Storage

OS Update



Note: To update OS image, copy or place OS image file into the **root folder** of “Internal Storage” or “External Storage”

Touch  **App drawer icon** →  **Settings** and then

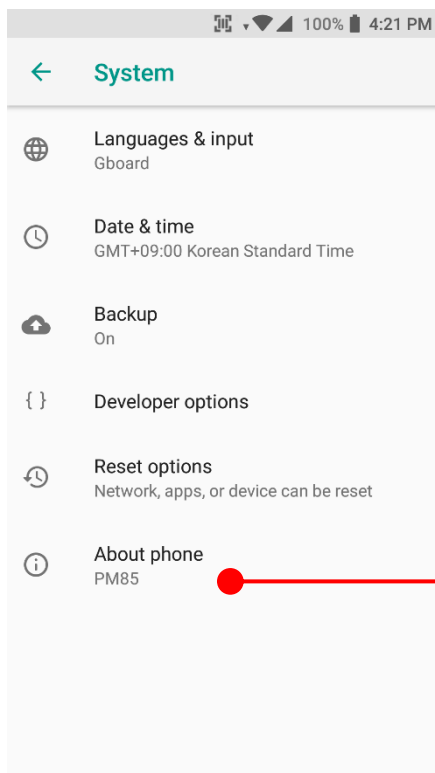

Touch **About phone**

OS Image update from a Storage

OS Update

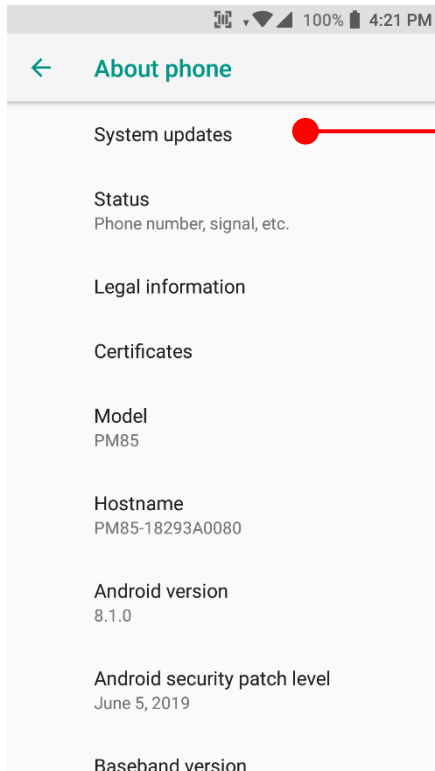

Touch **System updates**

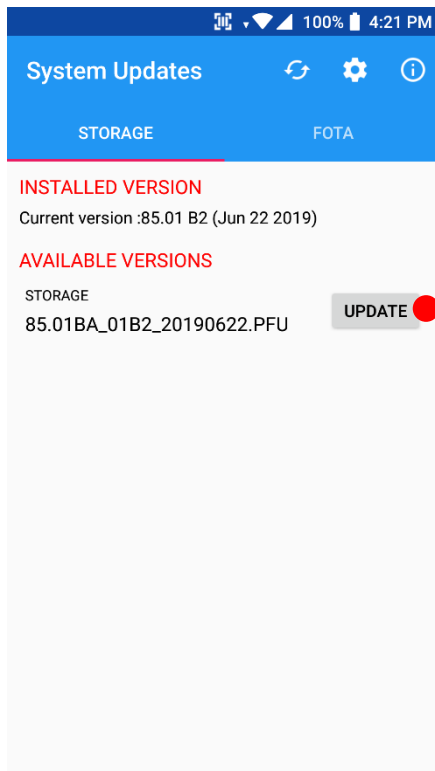

Your PM85 will check storage and display available OS image. Touch **UPDATE**

OS Image update from a Storage

OS Update

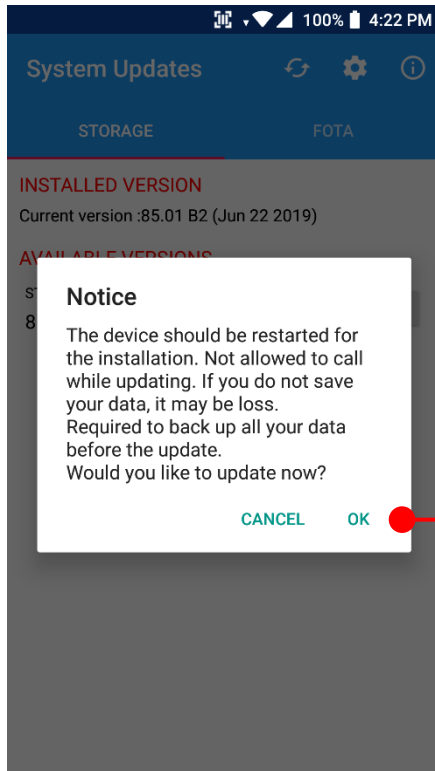

By touching the **OK** button, your PM85 start to update the OS image.

During this time, you cannot use your PM85. Please save the data before starting, the OS update process.

Note: Remaining battery level must be higher than 20%. Otherwise PM85 will not start OS update process. Please check battery level first

OS Image update from the FOTA

OS Update

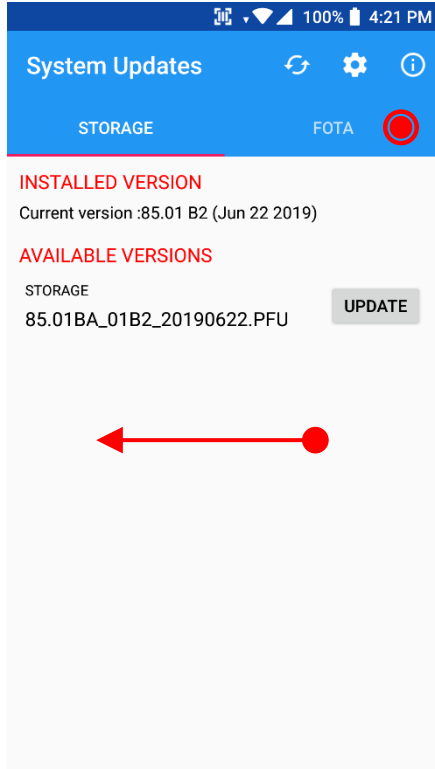

Swipe or touch **FOTA** tab

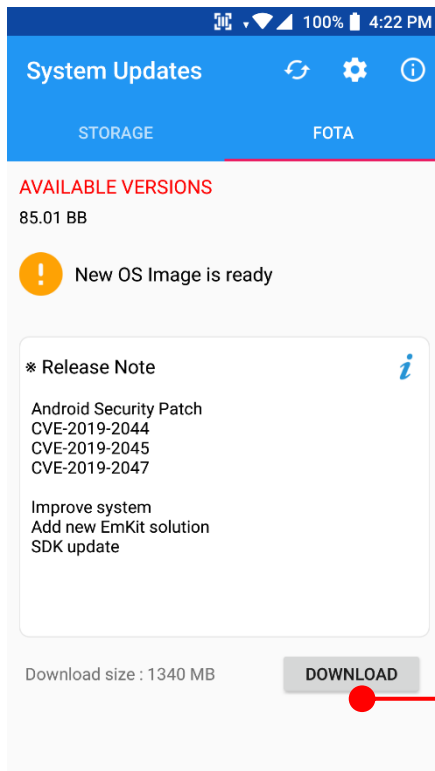

PM85 will compare the OS image between FOTA server and current OS image.

If there is newer OS image in the FOTA server, App will suggest download latest OS image

Touch **DOWNLOAD** button

OS Image update from the FOTA

OS Update

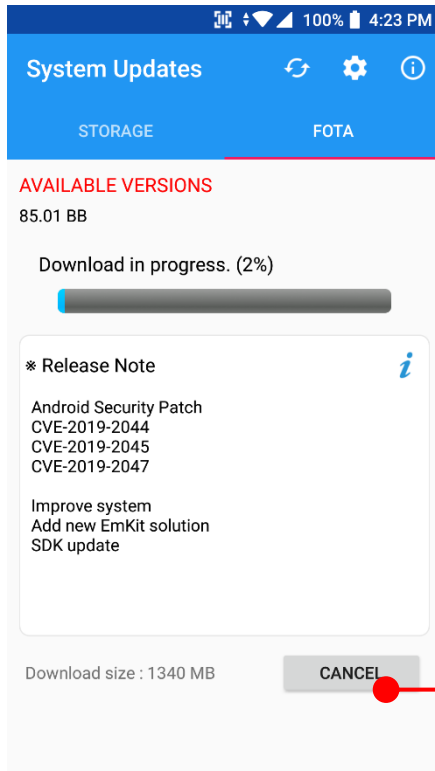

Touch to cancel the download process

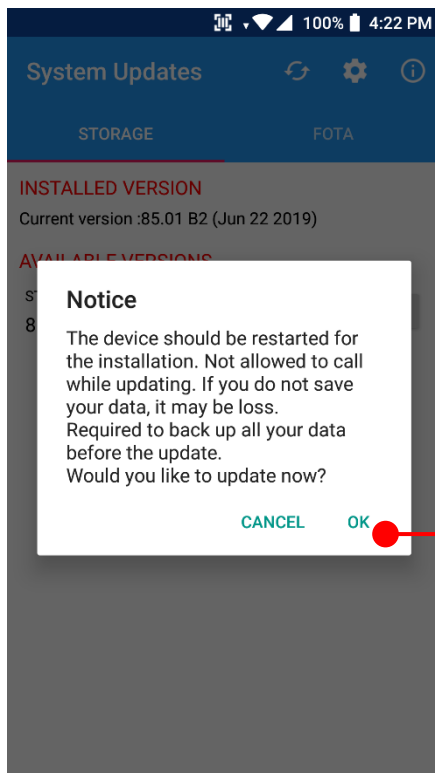

By touching the **OK** button, your PM85 start to update the OS image.

During this time, you cannot use your PM85. Please save the data before starting, the OS update process.



Note: Default OS image download setting of FOTA Client is "Download over Wi-Fi only" Please connect to the nearby Wi-Fi network for FOTA service

Remaining battery level must be higher than 20%. Otherwise PM85 will not start OS update process. Please check battery level first

Factory data reset from Settings

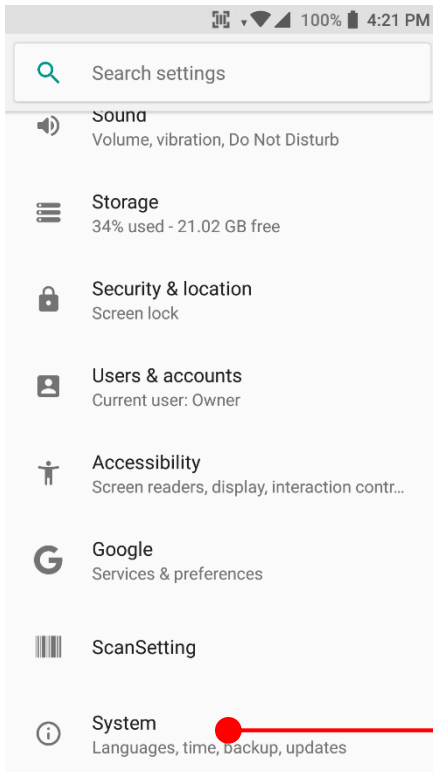
Factory data reset



Touch  **App drawer icon** →  **Settings** and then

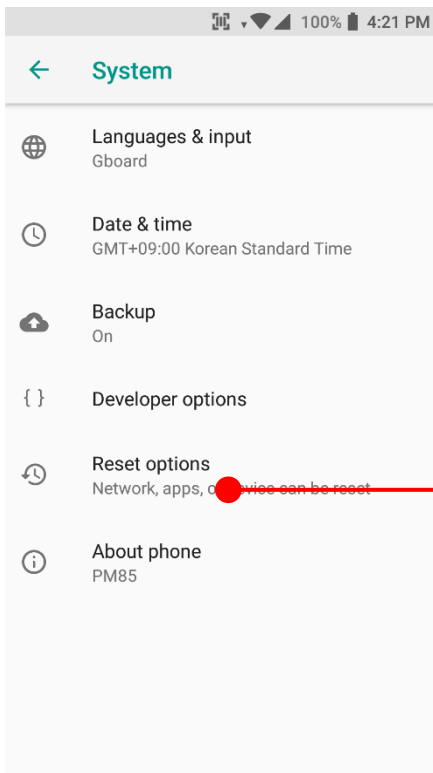

Touch **Reset options**

Factory data reset from Settings

Factory data reset

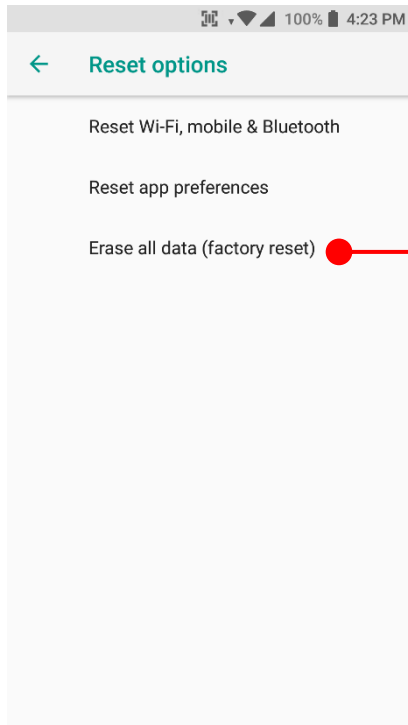

Touch **Erase all data (factory reset)**

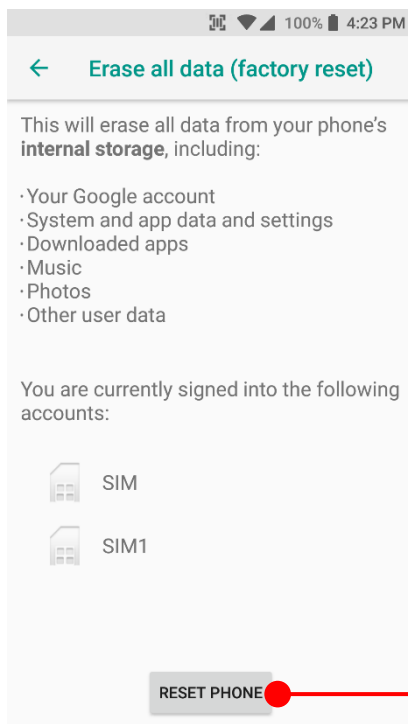

Touch **RESET PHONE**

Factory data reset from Settings

Factory data reset



Please note, all apps and data in the internal storage will be deleted and restored to “Factory default” and this process cannot “Undo”

Touch **ERASE EVERYTHING**

Force Factory data reset

Factory data reset

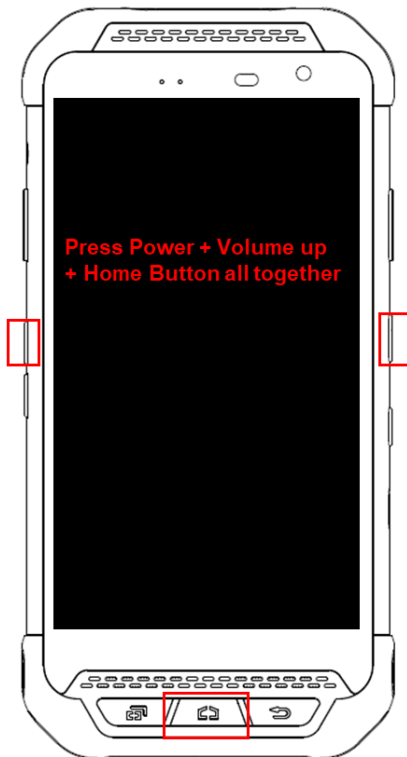

Force Factory data reset your PM85

You can perform “force” factory data reset your PM85. When your PM85 turned off, press **Power + Volume Up + Home** button all together. After you see **Smart Beyond Rugged** logo display, you may release the keys.

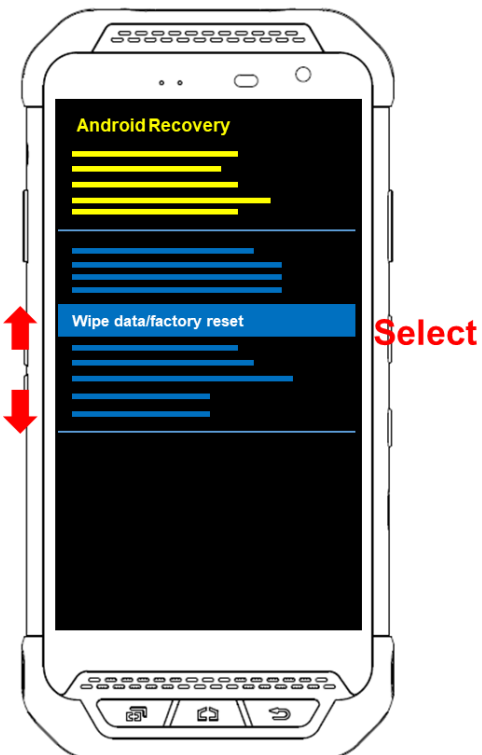

PM85 enter to the **Android Recovery** mode. In this mode, **Volume up** is **Move Up** in the menu tree and **Volume down** is **Move Down** in the menu tree. **Power Button** is **Select**

Force Factory data reset

Factory data reset



Select **Wipe data/factory reset**



Select **Yes wipe all user data** to perform the Factory data reset.

Force Factory data reset

Factory data reset

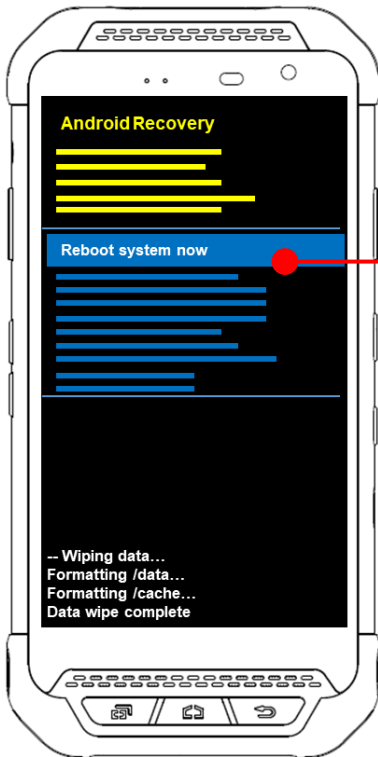
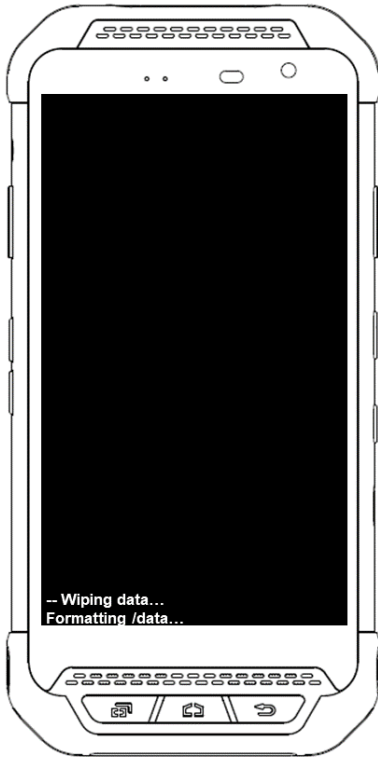

After data wiping, please select **Reboot system now** to finish the Force Factory data reset process

Force Factory data reset

Factory data reset

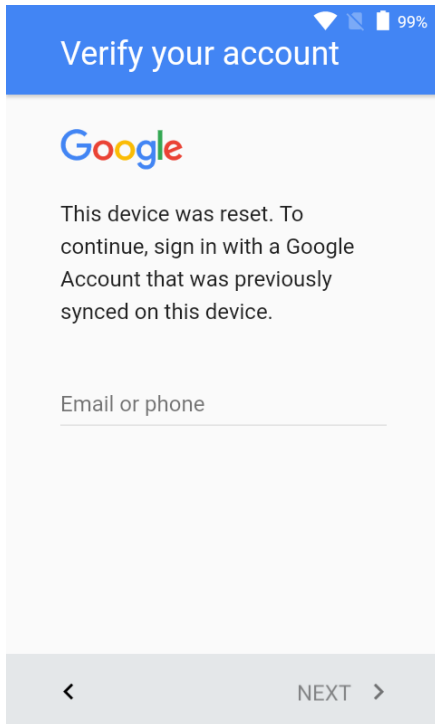

After Force factory reset, if PM Android Device locked by Factory Reset Protection, then please enter to Fast Boot mode and execute command

- fastboot erase config
- fastboot reboot

Note: Factory Reset Protection (FRP) is a security method that was designed to make sure someone can't just wipe and factory reset your device if you've lost it or it was stolen

Enterprise Mobility Kit

EmKit

Enterprise Mobility Kit – Truly, what Enterprise needs

Point Mobile announces new software solution – called **EmKit** is new software solution for enterprise mobility users. Our every Android device shall have EmKit pre-installed and every use can access them for free of charge*. EmKit offers truly-value-added advantages, for enterprise users, which are against consumer-centric & non-customizable smartphones. Every solution in EmKit is 100% compatible with Point Mobile Android GMS certified devices.

* Necessary MDM license subjects upon individual subscribers

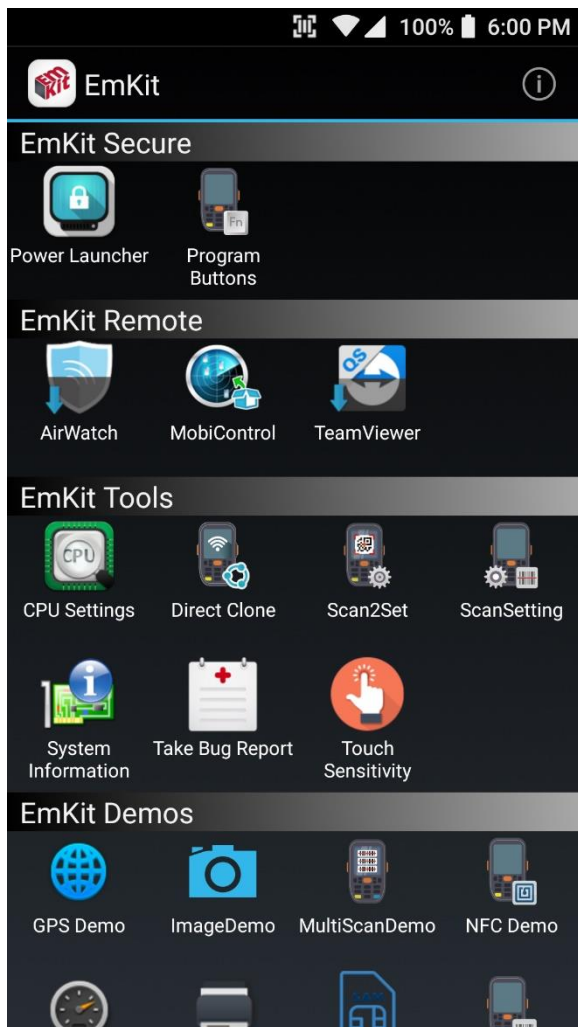

EmKit consist with **EmKit Secure**, **EmKit Remote**, **Emkit Tools** and **EmKit Demos**

- EmKit Secure **Lock Your Device**
- EmKit Remote **Mobile Device Management**
- EmKit Tools **Smarty Tools Ease Enterprise**
- EmKit Demos **Friendly for Programmers**

EmKit Secure

EmKit

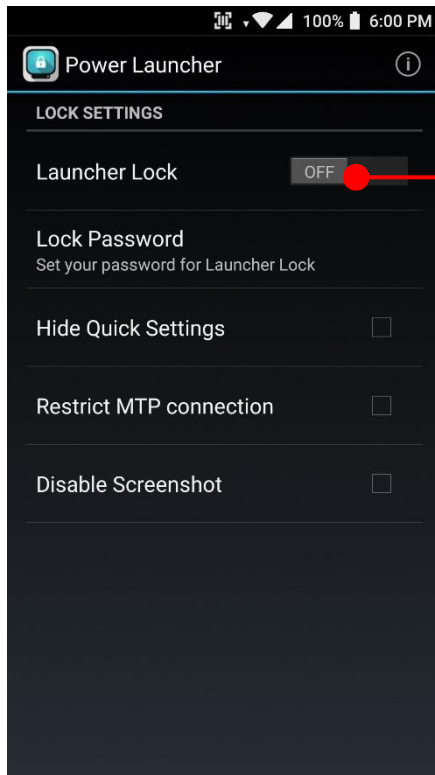

Power Launcher

You can lock your Point Mobile Android model's **Home Screen** and limit to access app drawer or specific function. This function as known as **Kiosk mode**.

- Hide Quick Settings : Limit to access quick setting panel
- Restrict MTP connection : Limit to access Point Mobile Device's MTP connection
- Screenshot Disable : Disable screenshot capture in OS level

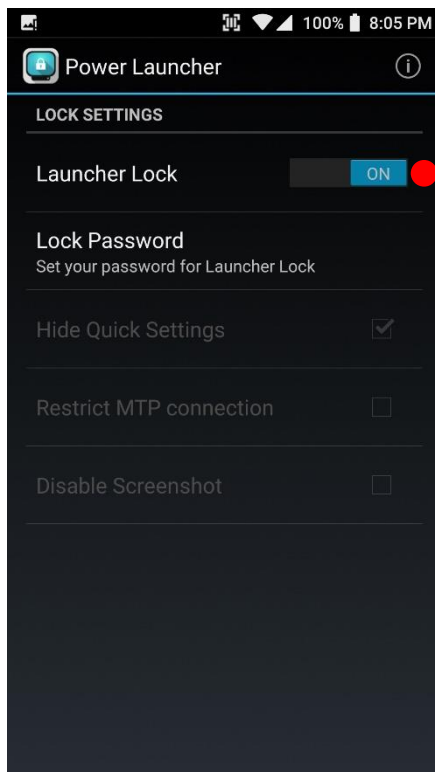

After restriction feature check, switch **Launcher Lock** to On.

EmKit Secure

EmKit

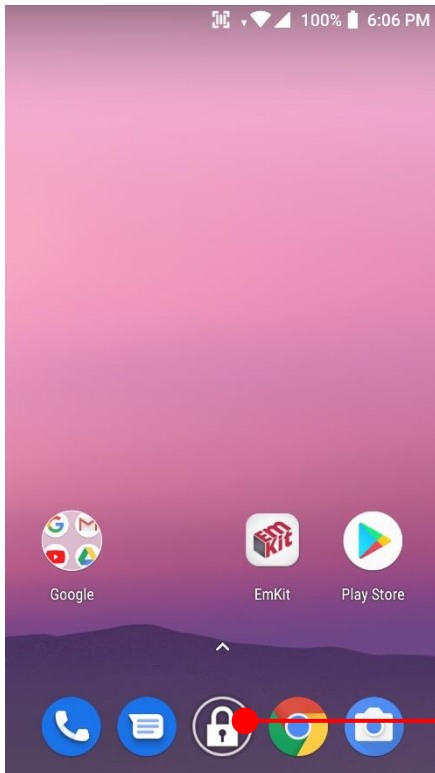

When Power Launcher is locked, operator could not access to **App drawer**.

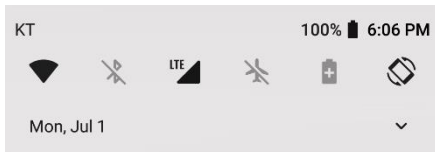

Android System ^
 Couldn't capture screenshot.
 Taking screenshots isn't allowed by the app or your organization

Example of **Screenshot Disable** restriction.

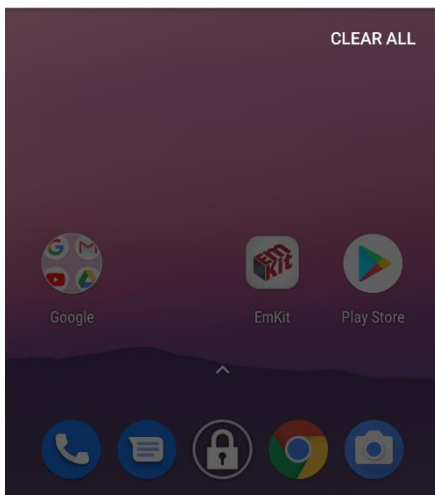

EmKit Secure

EmKit

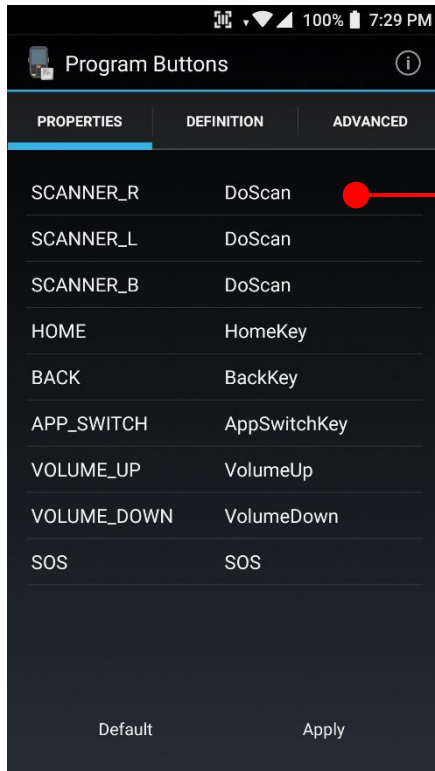

Program Buttons

You can assign Hardware buttons function to rich pre-assigned functions.

Touch one of hardware button

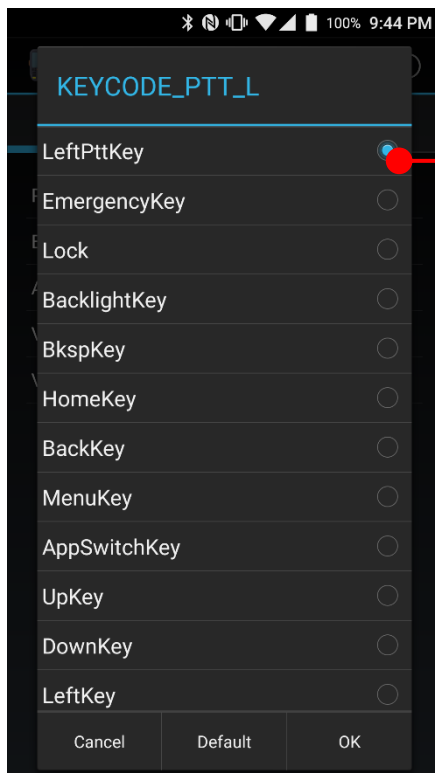

Touch to set pre-assigned function to the hardware button

EmKit Secure

EmKit

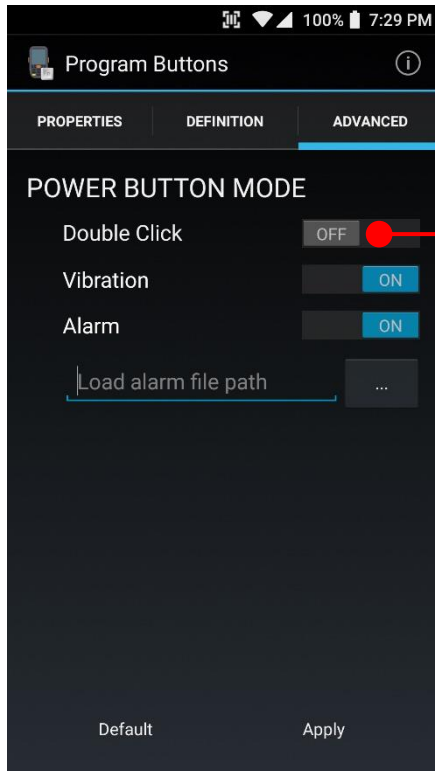

In **Advanced** tab, you can assign power button's function. Default is when Power button pressed, PM85 turn off the screen.

If **Double Click** mode enabled, you need to click the power button twice to turn off the PM85 screen. When you single click the power button, PM85 will vibrate or play alarm sound to inform **Power button is pressed instead of Scanner button**

EmKit Remote

EmKit



To install the AirWatch agent to Point Mobile Android device, please touch AirWatch icon

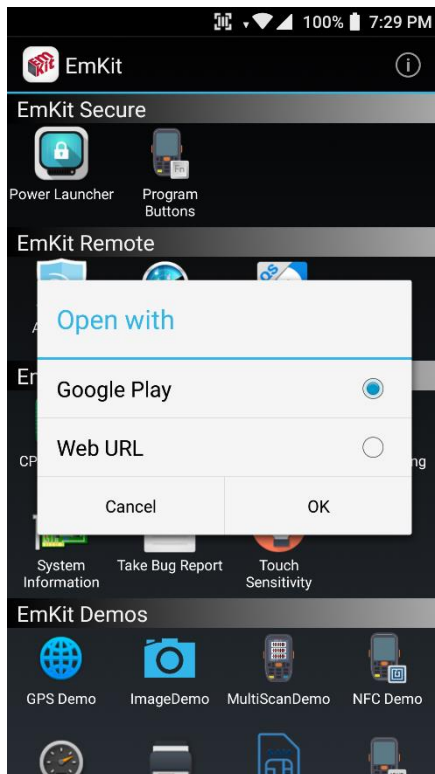

App provides AirWatch agent install via Google Play or Web URL.

- Google Play method requires Google account login. AirWatch agent download and install by Google Play
- Web URL method requires user's manual installation

EmKit Remote

EmKit

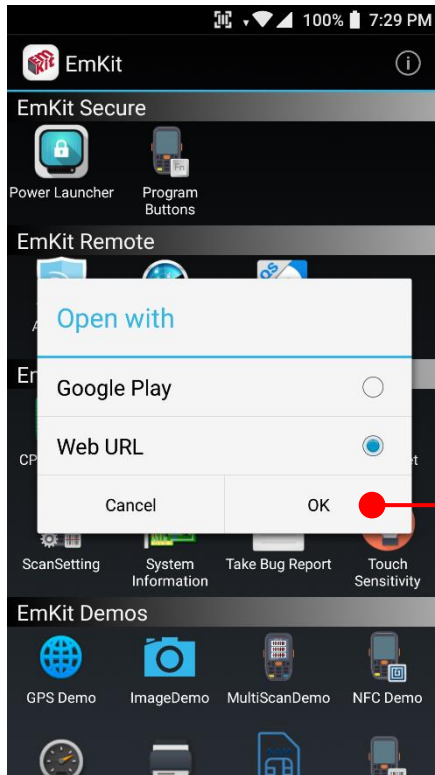

To install AirWatch agent from Web URL method, select the option and then **OK**

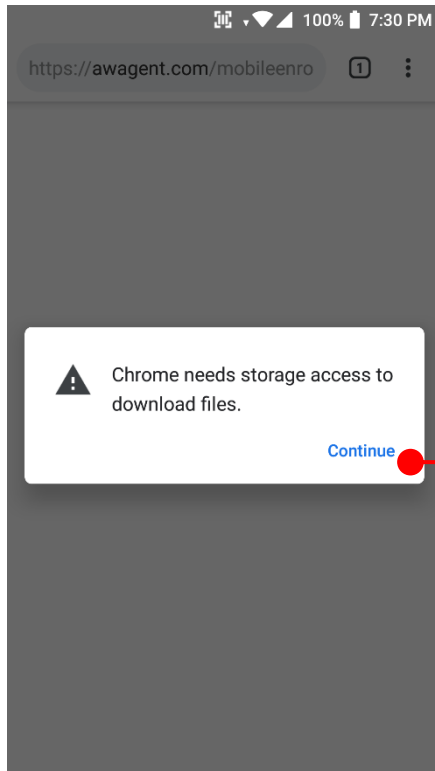

Web browser will download the apk file to the Point Mobile Android device. Before downloading, browser need permission to download apk file to the storage. Please touch **Continue**

EmKit Remote

EmKit

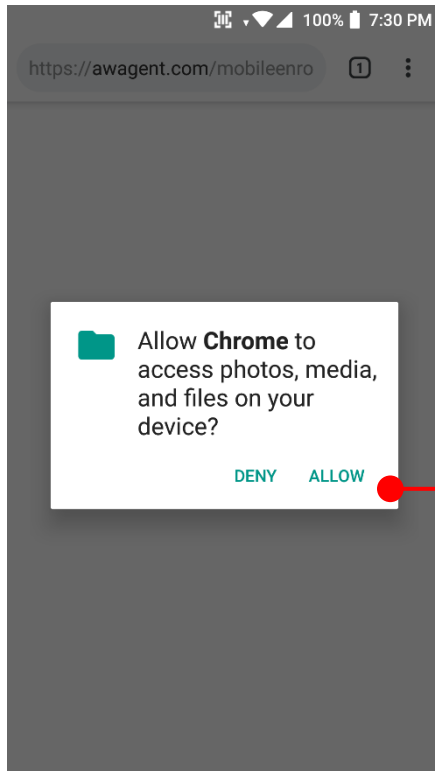

Touch **ALLOW** to grant web browser's file access

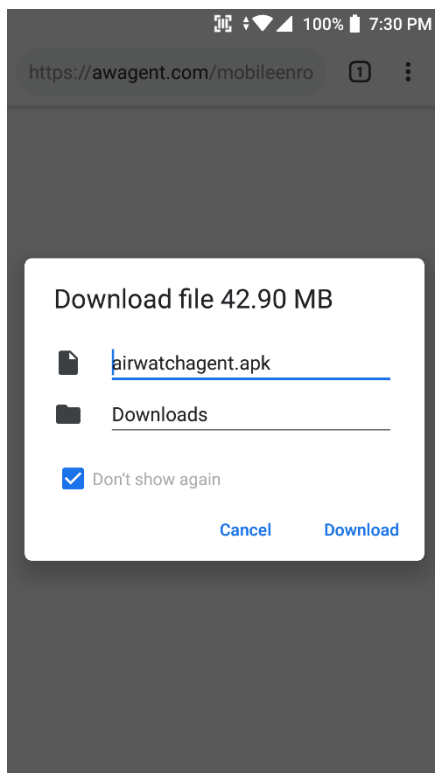

After permission update, web browser downloads the latest version of AirWatch agent apk file. Install this apk file to Point Mobile Android device.

Note: If you need to install specific agent version, please contact to AirWatch

EmKit Remote

EmKit

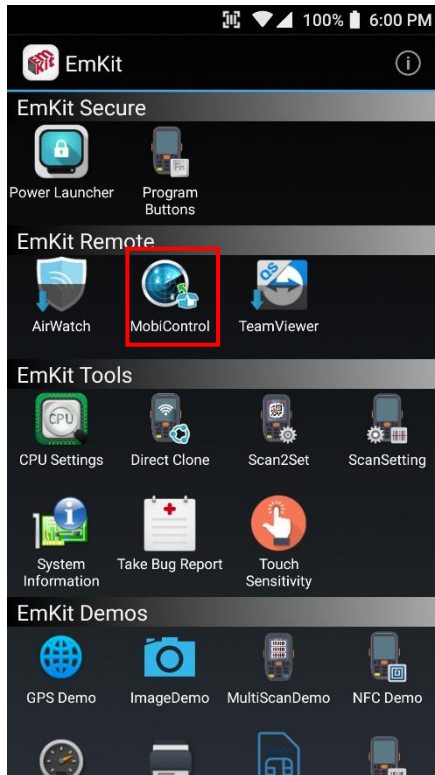

SOTI Mobi Control installer is pre-installed to Point Mobile Android device. To start enrollment process, please touch MobiControl icon

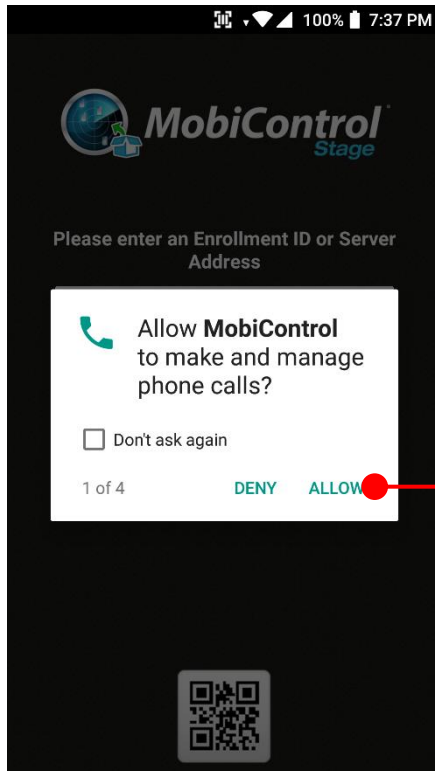

Mobi Control app request permission grant during enrollment process. Touch **ALLOW**

EmKit Remote

EmKit

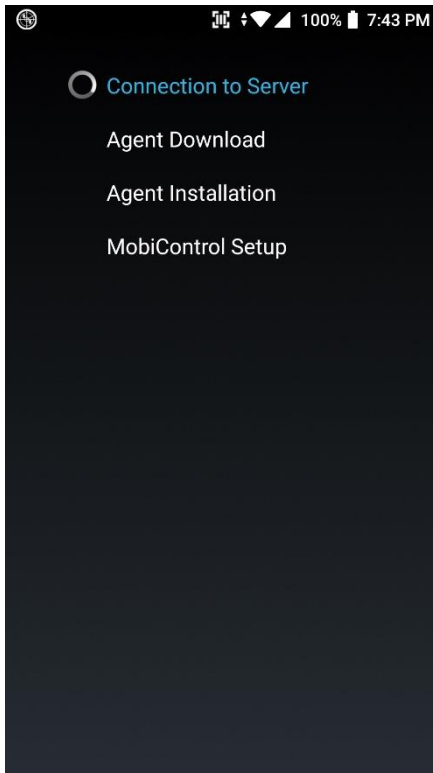

After login, Mobi Control app communicate with SOTI server and then install the Mobi Control agent

Note: Agent version determine from SOTI console's setting. If agent version is incorrect after enrollment, please contact to SOTI

EmKit Remote

EmKit

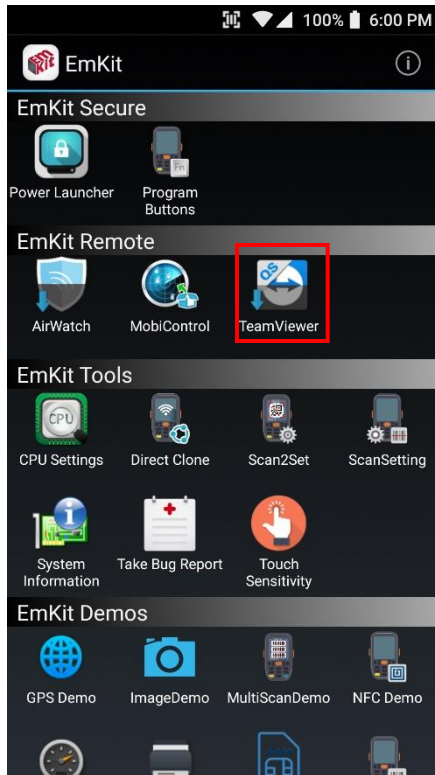

To install the TeamViewer QS app to Point Mobile Android device, please touch TeamViewer icon

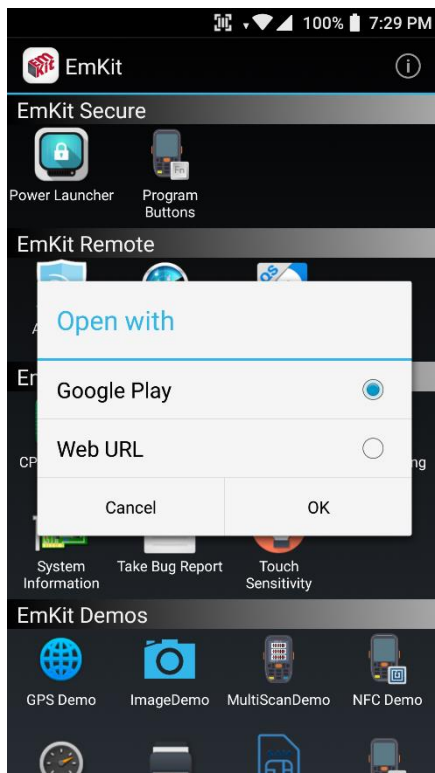

App provides TeamViewer QS app install via Google Play or Web URL.

- Google Play method requires Google account login. TeamViewer QS app download and install by Google Play
- Web URL method requires user's manual installation

EmKit Remote

EmKit

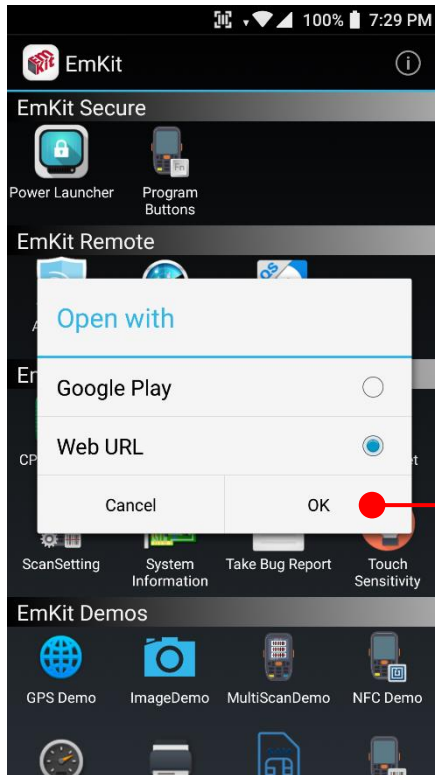

To install TeamViewer QS app from Web URL method, select Web URL and then **OK**

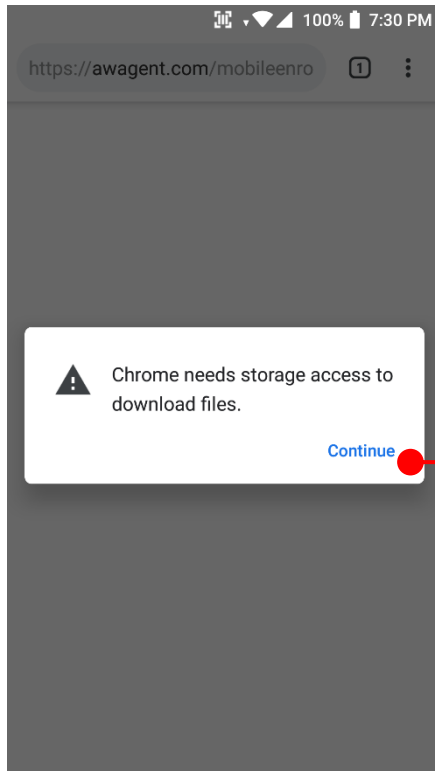

Web browser will download the apk file to the Point Mobile Android device. Before downloading, browser need permission to download apk file to the storage. Please touch **Continue**

EmKit Remote

EmKit

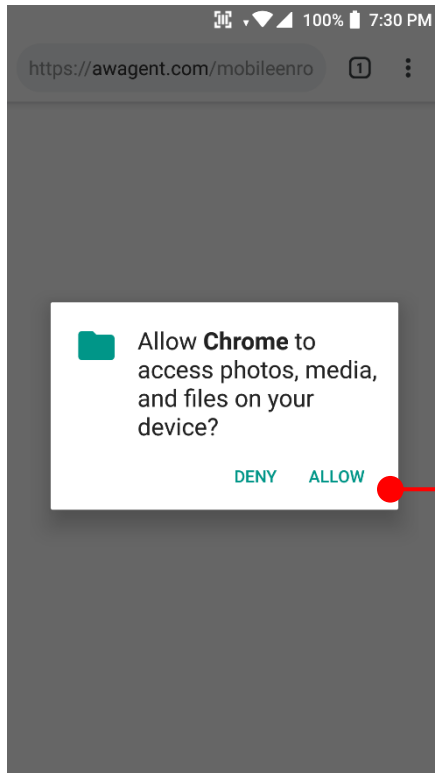

Touch **ALLOW** to grant web browser's file access

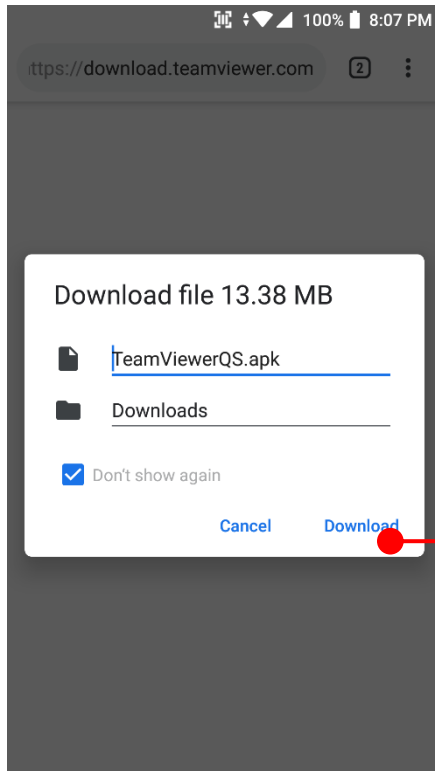

After permission update, web browser downloads the latest version of TeamViewer QS apk file. Install this apk file to Point Mobile Android device.

Note: If you need to install specific agent version, please contact to TeamViewer

EmKit Tools

EmKit

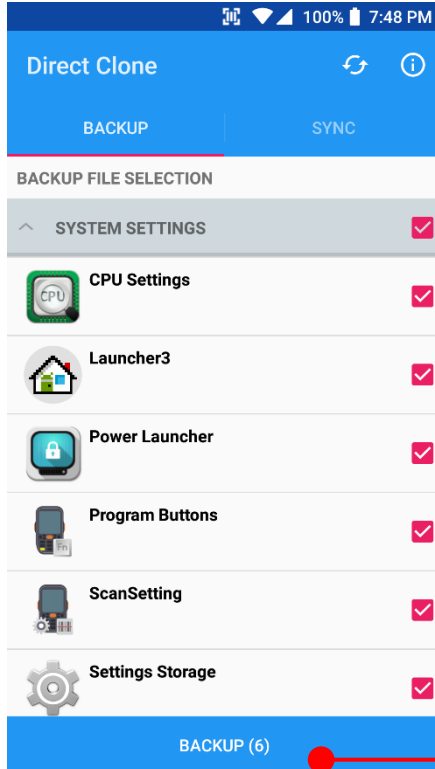

Direct Clone

Create the **Master PDA** - backup your system settings and apps into a secured file. Without any network connection, Master PDA become a local server in your work place. Nearby Point Mobile device will automatically communicate with Master PDA and download the backup file and then **Restore**.

Create the backup file

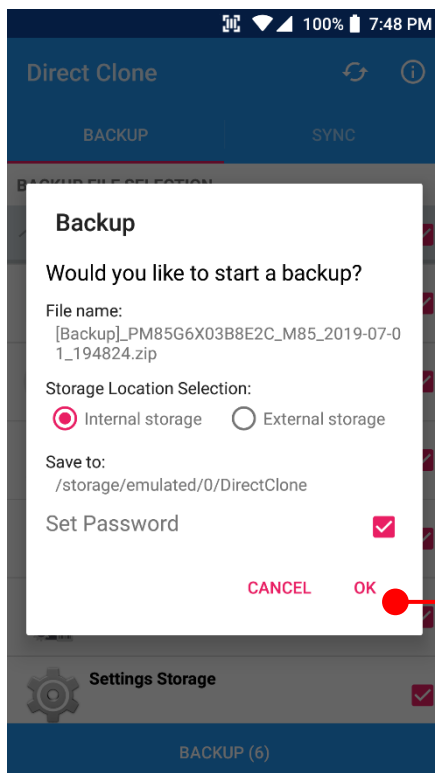

Set backup file location, password option and then touch **OK**

EmKit Tools

EmKit

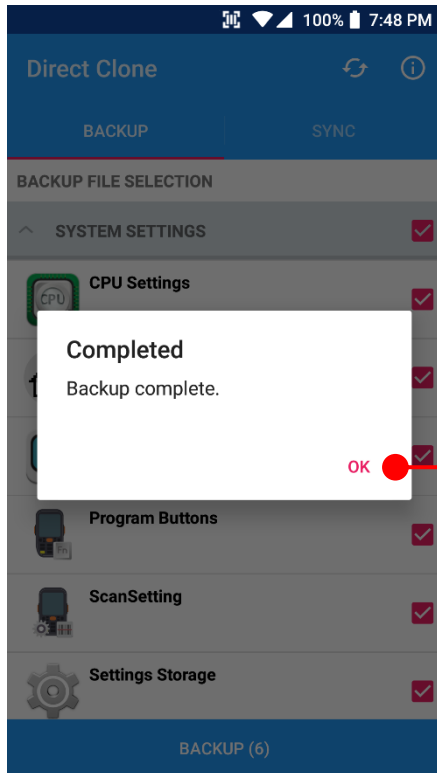

Touch **OK**

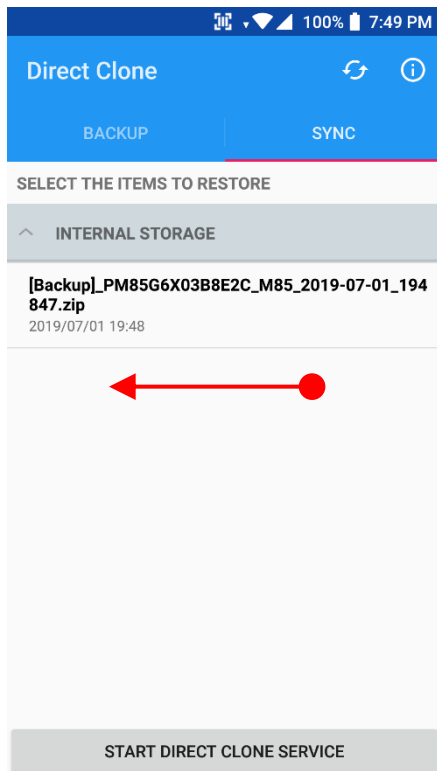

Swipe the screen, in the SYNC tab, you can find backup file.

EmKit Tools

EmKit

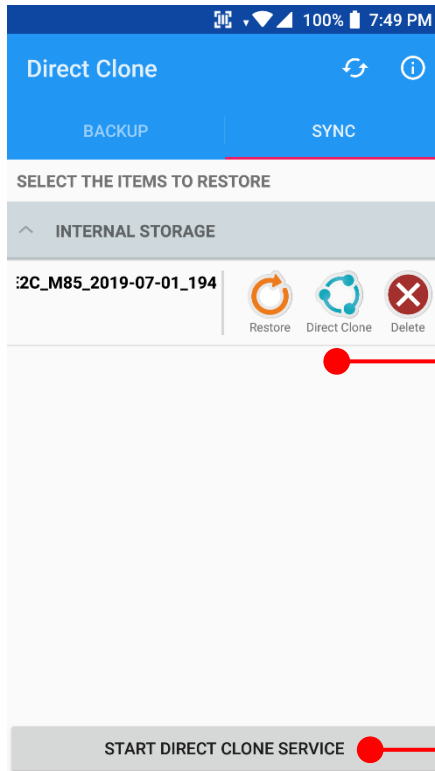

Touch Backup file. You will find **Restore**, **Direct Clone** and **Delete** option

Touch to receive file from master PDA

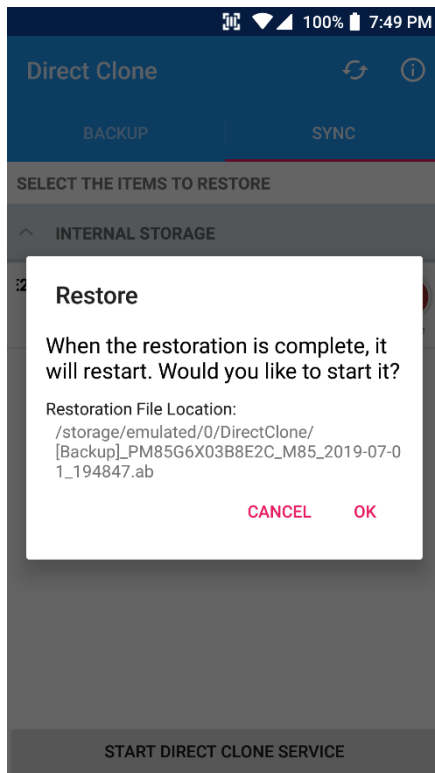

Restore PM85 with selected file

EmKit Tools

EmKit

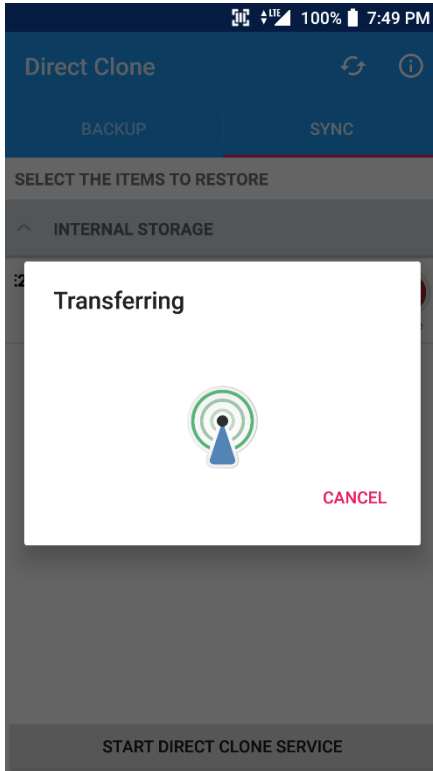

Transferring Direct Clone file

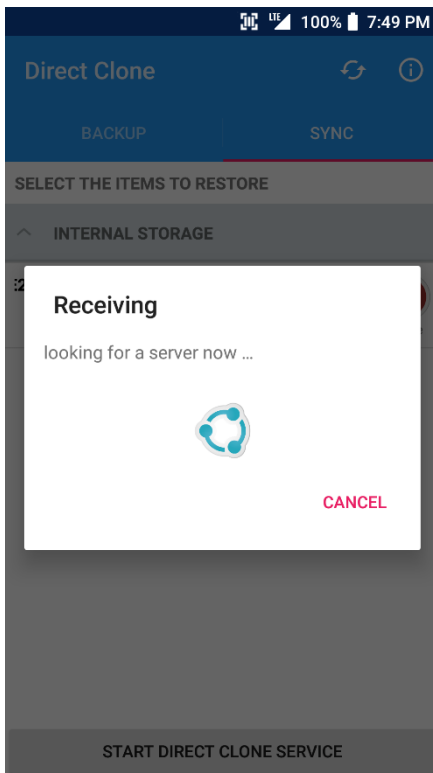

Receiving Direct Clone file

EmKit Tools

EmKit

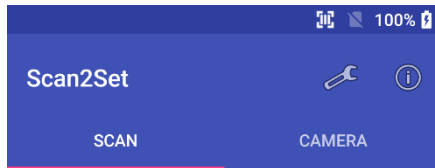

Scan2Set

Scan2Set is designed for the network environment. Point Mobile Android device downloads the Direct Clone file from the FTP, Web server or Cloud such as Dropbox or Google Drive with just one QRcode Scan!



- Scan your QR code and,
- Connect to your network
 - Restore your PDA
 - Work Managed Device setup

START SCAN

Step 1. Create Direct Clone Backup file

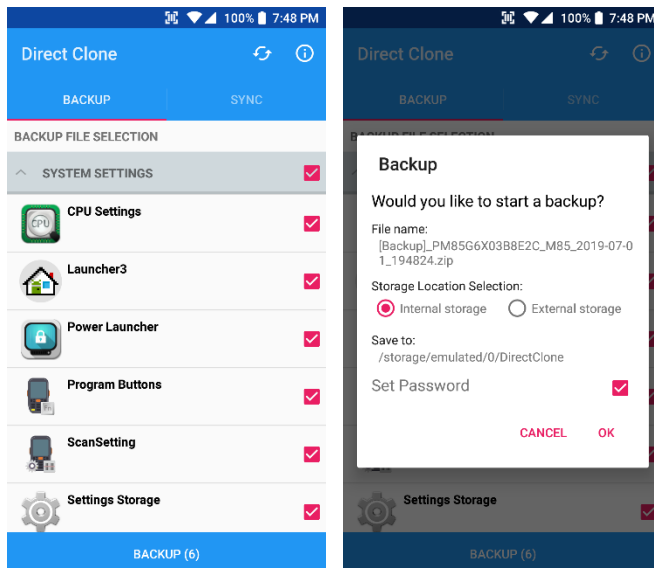

- Make a Direct Clone file from Master PDA device

EmKit Tools

EmKit

Step 2. Upload Direct Clone file to your FTP site or Web server

- Copy the Direct Clone file from the Point Mobile Android device

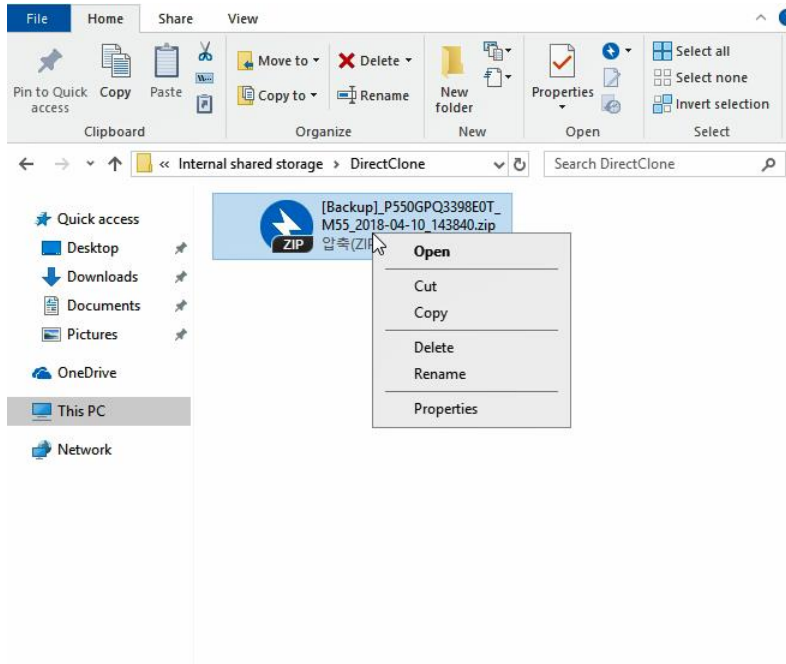

- Upload this file to your FTP site or Web Server. You may change file name

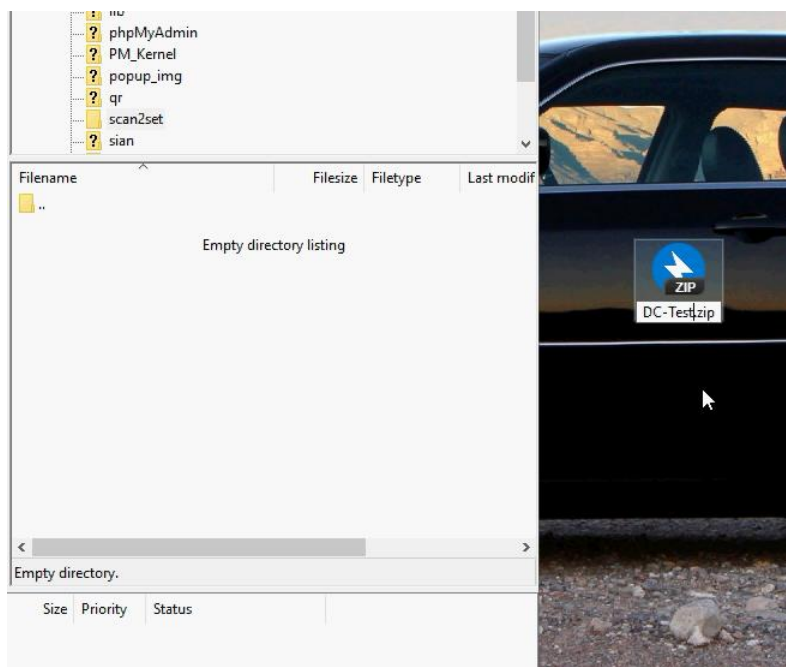

EmKit Tools

EmKit

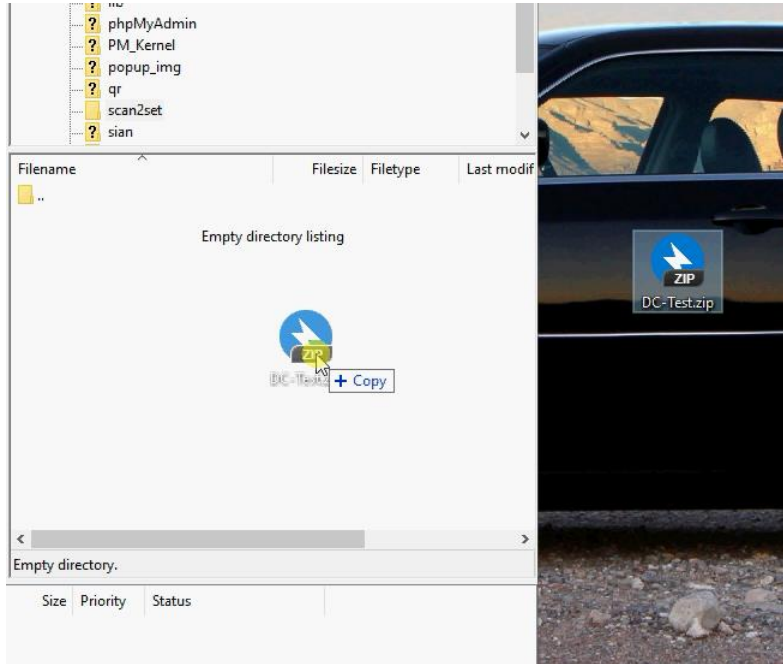

- After file uploading, please check the url first. **File should be download with url address.**

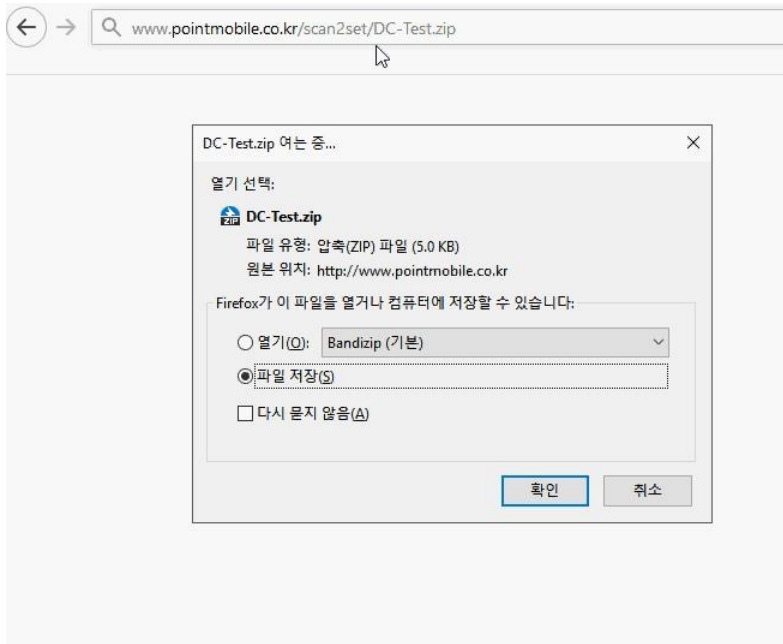

EmKit Tools

EmKit

Step 3. Generate QRcode

- Access to Web QRcode generating site www.pointmobile.co.kr/qr

Web/Google Drive

FTP

Work Managed Device Enrollment

json format

Scan2Set

SCAN START

Network Setup

SSID :

Hidden

Password :

Security Type : None WEP WPA,WPA2,WPA2PSK

Direct Clone File Location

URL : *

File Name : *

Password :

Generate QRcode Clear

- Click **Web/Google Drive** menu
- Input Network information, Direct Clone file name and password

Web/Google Drive

FTP

Work Managed Device Enrollment

json format

Scan2Set

Welcome

Power off

Reboot

Direct Clone

Scan2Set

Network Setup

SSID :

Hidden

Password :

Security Type : None WEP WPA,WPA2,WPA2PSK

Direct Clone File Location

URL : *

File Name : *

Password :

Generate QRcode Clear

EmKit Tools

EmKit

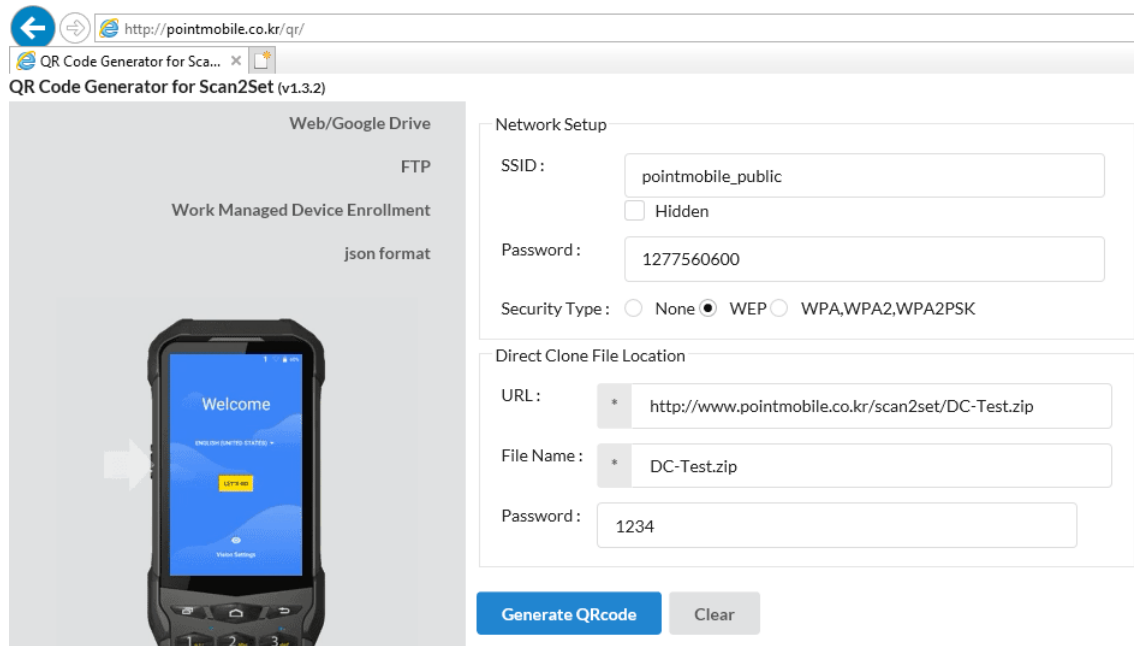

Note: Make sure put http:// or https:// in front of url address

- Click **Generate QRcode** button and save or print generated QRcode

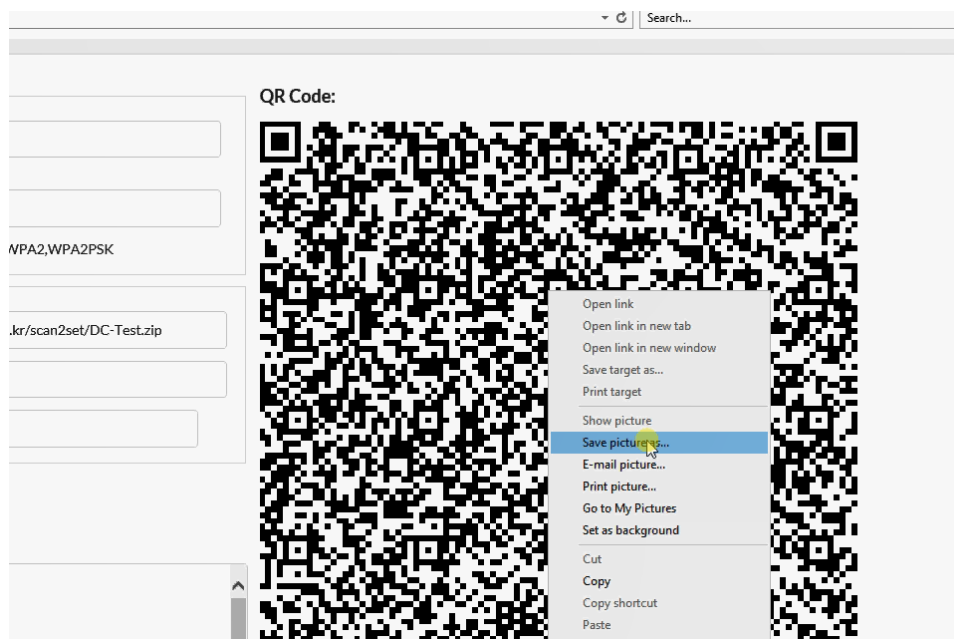

EmKit Tools

EmKit

Step 4. Read QRcode in other PDAs

- Turn on your Point Mobile Android device.
- Press the Power Button, then you will see the Scan2Set in the menu

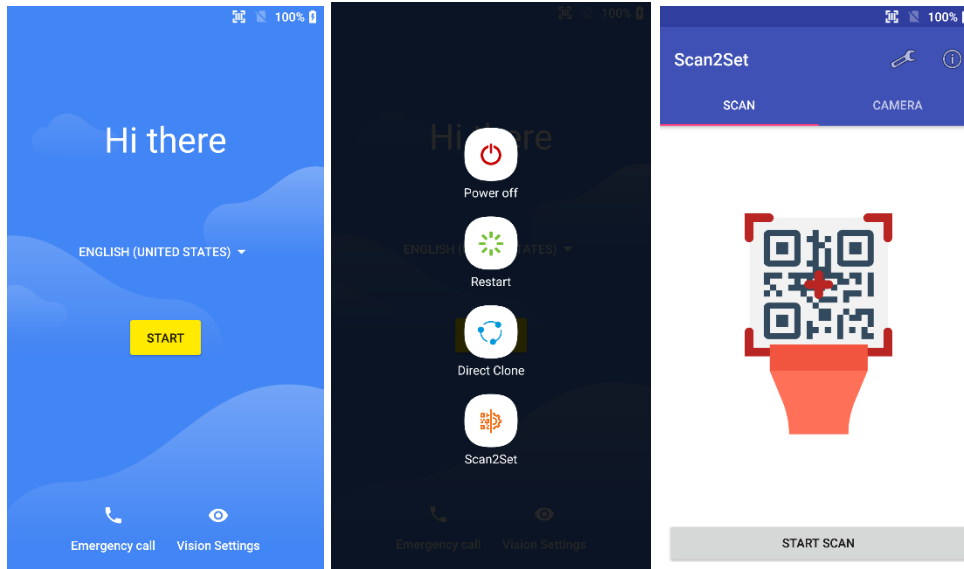

- Read the generated QRcode. Point Mobile Android device will download the file from the FTP site or Web server and restore Direct Clone file

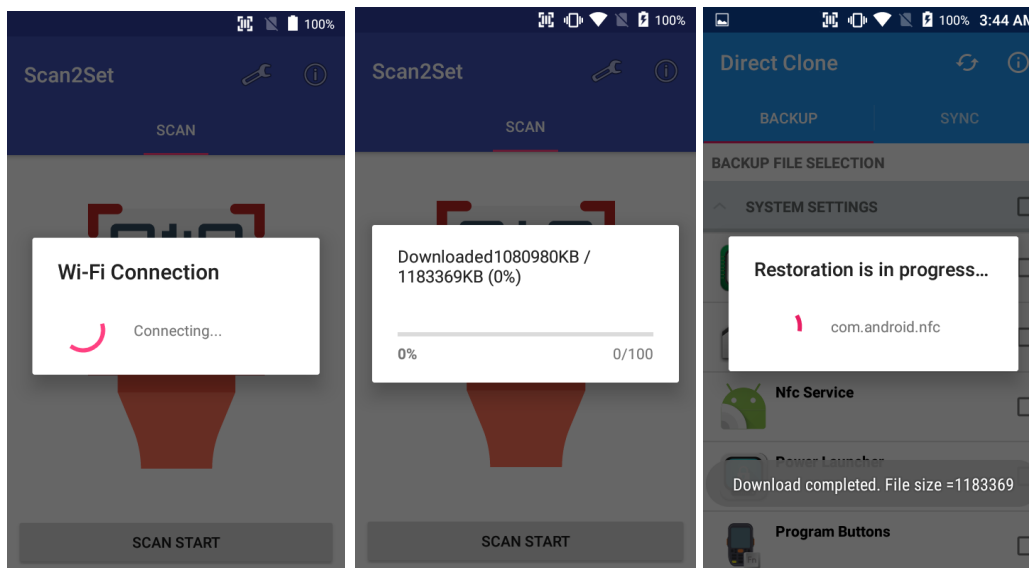

EmKit Tools

EmKit



System information

All of SW and HW information available here and can save it to the file.

- Touch **Save to file**.
- **devinfo.html** file saved to root folder of the internal storage.

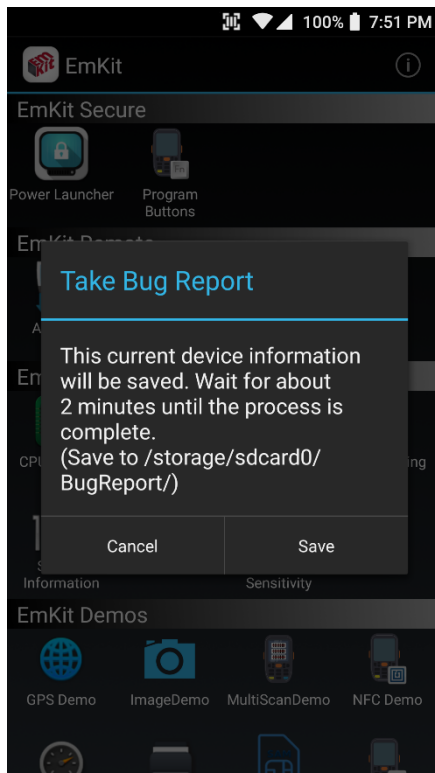

Take Bug Report

This function saves logs and event to the internal storage. When you have a field issue, and need to contact service center, please find the reproduce step first.

- Reproduce the issue.
- After issue, reproduce, please run **Take bug report**.
- File will be saved to **BugReport** folder.
- Copy the file to the PC and then zip it to reduce the file size.
- Share bug report file to the service center or Point Mobile Support team with reproduce steps.

EmKit Tools

EmKit

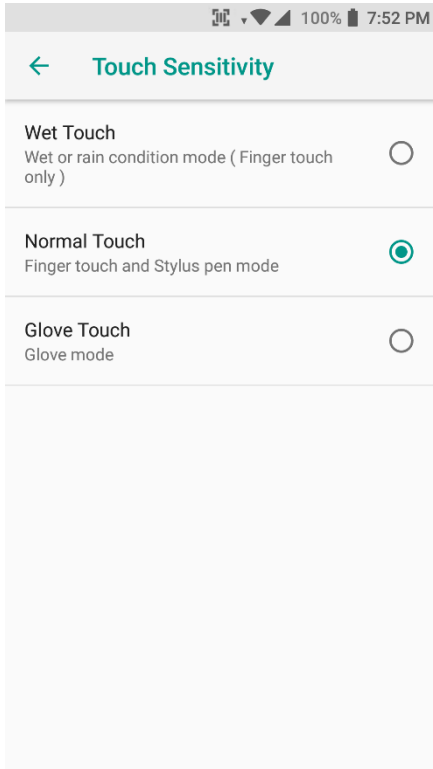

Touch Sensitivity

Set screen's touch screen sensitivity option. You can set Wet touch mode or Glove touch mode here

EmKit Demos

EmKit

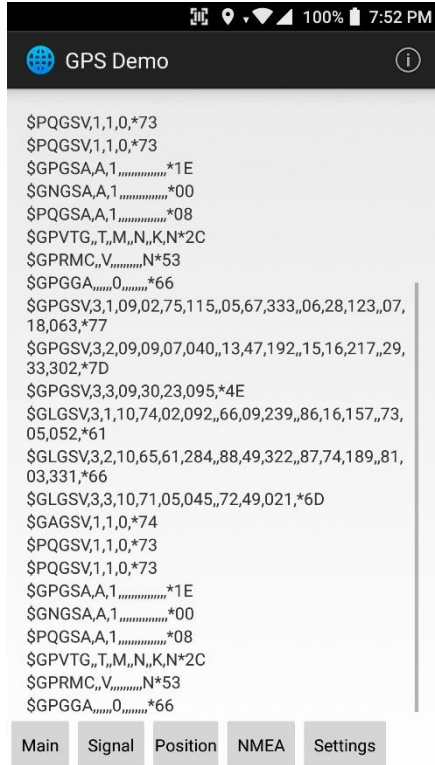

GPS Demo

Developer can demonstrate or check Point Mobile Android model's GPS signal strength, Satellite info, NMEA info.

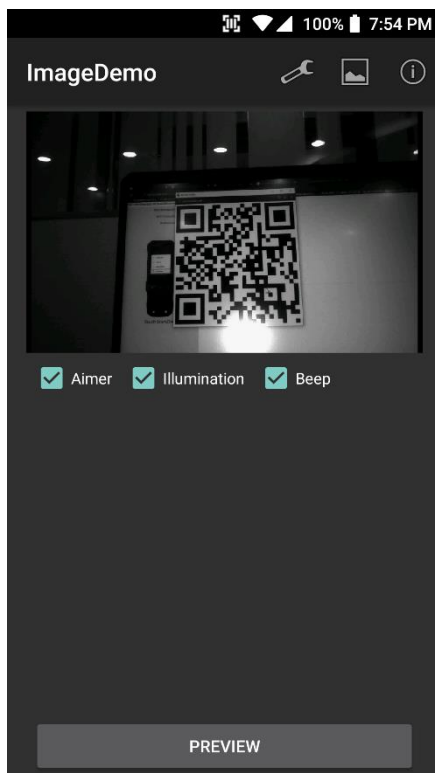

Image Demo

Developer can demonstrate or check Point Mobile Android model's 2D scanner's image taking solution.

Some of demo app only available for specific Hardware feature integrated SKU (Stock Keeping Unit)

EmKit Demos

EmKit

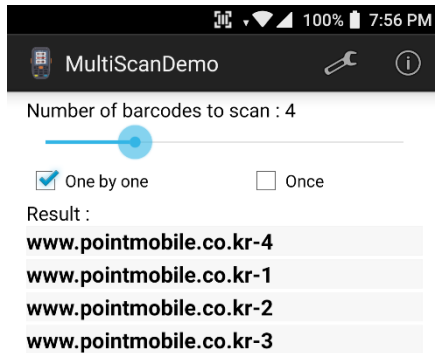

MultiScan Demo

Developer can demonstrate or check Point Mobile Android model's Scanner solution. You can read multi barcodes

Some of demo app only available for specific Hardware feature integrated SKU (Stock Keeping Unit)

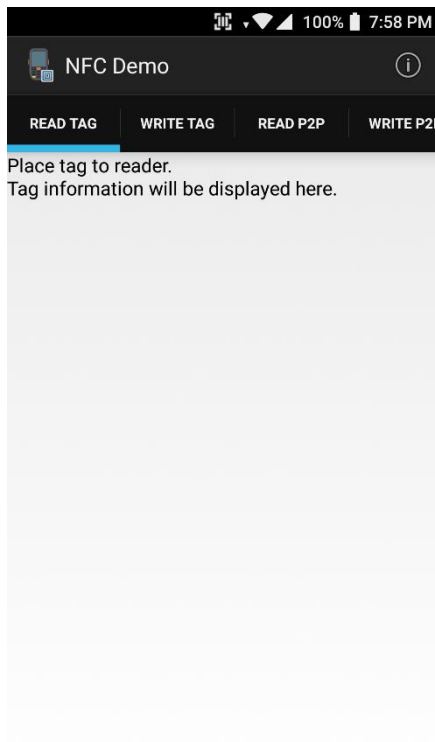

NFC Demo

Developer can demonstrate or check Point Mobile Android model's NFC Read/Write solution.

Some of demo app only available for specific Hardware feature integrated SKU (Stock Keeping Unit)

EmKit Demos

EmKit

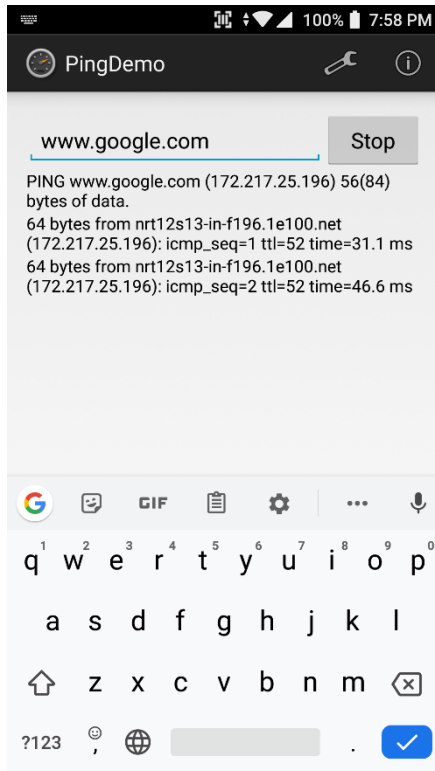

Ping Demo

Developer can demonstrate or check Point Mobile Android model's ping test.

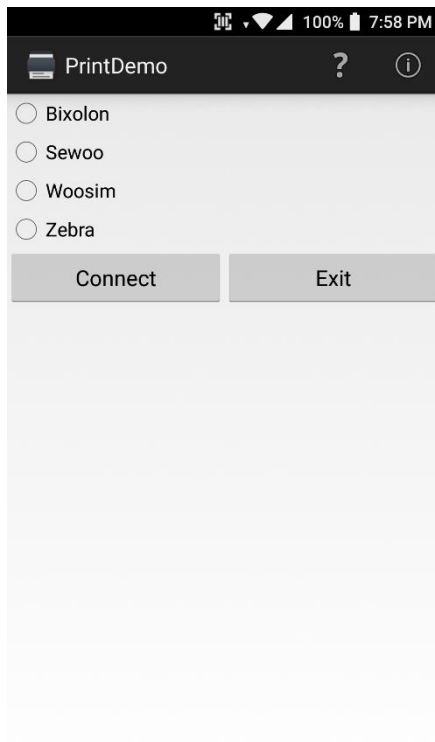

Print Demo

Developer can demonstrate or check Point Mobile Android model's Bluetooth mobile printing solution

EmKit Demos

EmKit

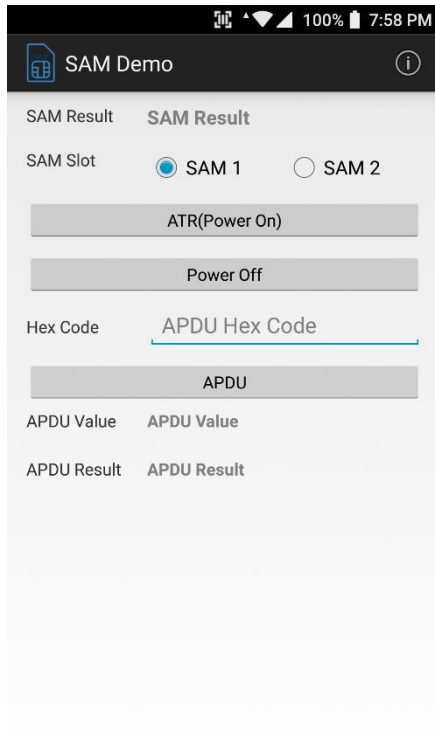

SAM Demo

Developer can demonstrate or check Point Mobile Android model's SAM communication.

Some of demo app only available for specific Hardware feature integrated SKU (Stock Keeping Unit)

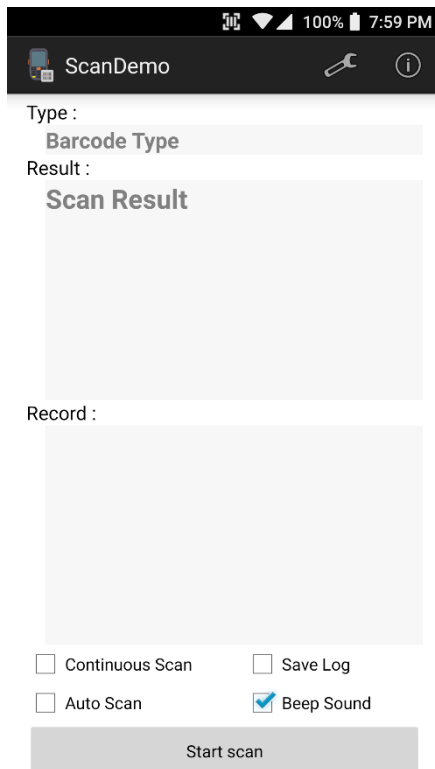

Scan Demo

Developer can demonstrate or check Point Mobile Android model's Scanner solution.

Some of demo app only available for specific Hardware feature integrated SKU (Stock Keeping Unit)

Safety and Legal Info



www.sar-tick.com

Body-worn Operation

This device was tested for typical body-worn operations with the front & back of the phone kept 0.2 inches (0.5 cm) between the user's body and the front & back of the phone. A minimum separation distance of 0.2 inches (0.5 cm) must be maintained between the user's body and the front & back of the phone. Any belt clips, holsters, and similar accessories containing metallic components may not be used. Body-worn accessories that cannot maintain 0.2 inches (0.5 cm) separation distance between the user's body and the front & back of the phone, and have not been tested for typical body-worn operations should be avoided.



PROTECT YOUR HEARING

To prevent possible hearing damage, do not listen at high volume levels for long periods. Exercise caution when holding your device near your ear while the loudspeaker is in use.

FCC Warning

This device complies with part 15 of the FCC Rules. Operation is subject to the following two conditions: (1) This device may not cause harmful interference, and (2) this device must accept any interference received, including interference that may cause undesired operation.

This equipment has been tested and found to comply with the limits for a Class B digital device, pursuant to part 15 of the FCC Rules. These limits are designed to provide reasonable protection against harmful interference in a residential installation. This equipment generates, uses and can radiate radio frequency energy and, if not installed and used in accordance with the instructions, may cause harmful interference to radio communications. However, there is no guarantee that interference will not occur in a particular installation. If this equipment does cause harmful interference to radio or television reception, which can be determined by turning the equipment off and on, the user is encouraged to try to correct the interference by one or more of the following measures:

- Reorient or relocate the receiving antenna.
- Increase the separation between the equipment and receiver.
- Connect the equipment into an outlet on a circuit different from that to which the receiver is connected.
- Consult the dealer or an experienced radio/TV technician for help.

Caution : Any changes or modifications to this device not expressly approved by the party responsible for compliance could void your authority to operate the equipment.

IC (Industry Canada) Warning

This device complies with Industry Canada license-exempt RSS standard(s). Operation is subject to the following two conditions: (1) This device may not cause interference; and (2) This device must accept any interference, including interference that may cause undesired operation of the device.

Le present appareil est conforme aux CNR d'Industrie Canada applicables aux appareils radio exempts de licence. L'exploitation est autorisee aux deux conditions suivantes : (1) l'appareil ne doit pas produire de brouillage, et (2) l'utilisateur de l'appareil doit accepter tout brouillage radioelectrique subi, meme si le brouillage est susceptible d'en compromettre le fonctionnement

This device is restricted to indoor use only within the 5.15 ~ 5.35GHz Band.

Cet appareil est restreint a l'utilisation a l'interieur seulement dans la bande 5.15 ~ 5.35GHz.

This equipment complies with FCC/IC radiation exposure limits set forth for an uncontrolled environment. This transmitter must not be collocated or operating in conjunction with any other antenna or transmitter unless authorized to do so by the FCC/IC.

Cet equipement est conforme aux limites d'exposition aux radiations FCC / IC definies pour un environnement non controle. Cet emetteur ne doit pas etre colocalise ou fonctionner en conjonction avec une autre antenne ou un autre emetteur, a moins d'etre autorise a le faire par le FCC / IC

E-label

Users can access to the product certificate information in Settings → About phone → Certificates.

WCDMA/LTE feature is optional

Some product options only include WLAN feature.

	WLAN	PHONE
FCC ID	V2X-PM85W	V2X-PM85G
IC ID	10664A-PM85W	10664A-PM85G



POINT MOBILE. CO., LTD.

Offline

Tel: +82-2-3397-7870~1

ARS: +82-1800-3010

Fax: +82-2-3397-7872

Address: B-9F Kabul Great Valley, 32, Digital-ro 9-gil,
Geumcheon-gu, Seoul, Korea 08512

Online

Website: <http://www.pointmobile.co.kr/>

E-mail: pm_support@pointmobile.co.kr