



For Android™ 6.0.1

# Enterprise Mobility

# PM66

# User Manual

# User Manual

Please note your phone is battery-embedded design with removable battery and battery cover. Unauthorized personnel are strictly prohibited from disassembling the phone. Make sure to use only the power adapter (5V 2A Output AC/DC) that came with PM66.

In case your phone does not work as expected, you are strongly recommended to restart it by pressing and holding the power button for at least 12 seconds until the startup screen appears. If your phone has encountered a serious error and cannot be recovered, you should reset your phone to factory settings by using the menu, either “Backup & Reset”, or “Factory Reset”. For more details, please refer to “Factory data reset” section on page 42

**Note:** Please be cautious while performing the factory data reset. Because this will erase personalized settings and data saved in your phone, such as SMS, Contacts, Music, etc.



[www.sar-tick.com](http://www.sar-tick.com)

## Body-worn Operation

This device was tested for typical body-worn operations with the front & back of the phone kept 0.2 inches (0.5 cm) between the user's body and the front & back of the phone. A minimum separation distance of 0.2 inches (0.5 cm) must be maintained between the user's body and the front & back of the phone. Any belt clips, holsters, and similar accessories containing metallic components may not be used. Body-worn accessories that cannot maintain 0.2 inches (0.5 cm) separation distance between the user's body and the front & back of the phone, and have not been tested for typical body-worn operations should be avoided.



## PROTECT YOUR HEARING

To prevent possible hearing damage, do not listen at high volume levels for long periods. Exercise caution when holding your device near your ear while the loudspeaker is in use.

Rev 03

# Table of Contents

User Manual.....	1
Table of Contents.....	2
Getting Started.....	3
Major Parts .....	3
Accessory .....	5
Setup PM66.....	6
Charge PM66.....	9
Turn On/Off PM66.....	10
Hot swap the battery .....	11
Learning the basics.....	12
Use a keypad .....	12
Use a touch screen .....	14
Home Screen, Apps and Widget.....	16
Status & Notifications Icons .....	20
Make a call .....	22
Add to a contact.....	24
Send a message.....	25
Connect to your Wi-Fi network.....	27
Scanner Settings .....	29
Use a Scanner .....	29
Scan a Barcode .....	36
OS Update.....	38
OS Image update from a Storage.....	38
OS Image update from the FOTA.....	40
Factory data reset .....	42
Factory data reset from Settings.....	42
Force Factory data reset.....	44
EmKit.....	47
EmKit Secure .....	48
EmKit Remote.....	51
EmKit Tools.....	59
EmKit Demos .....	68

# Major Parts

## Getting Started



1. Barcode Scanner

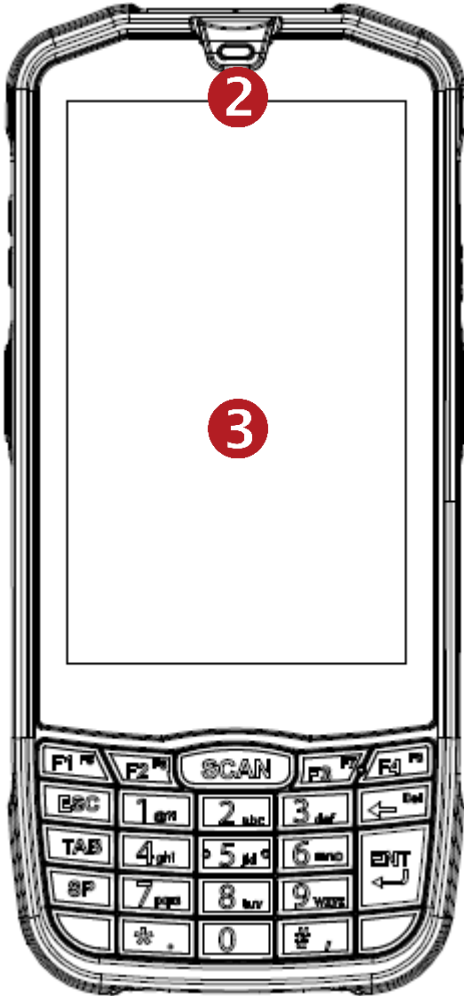

2. Speaker

3. Touch Screen

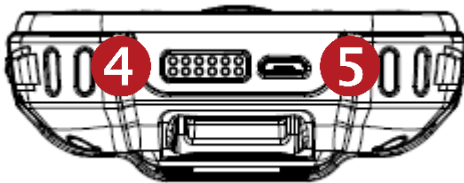

4. Pogo pin connector

5. micro USB

## Major Parts

## Getting Started

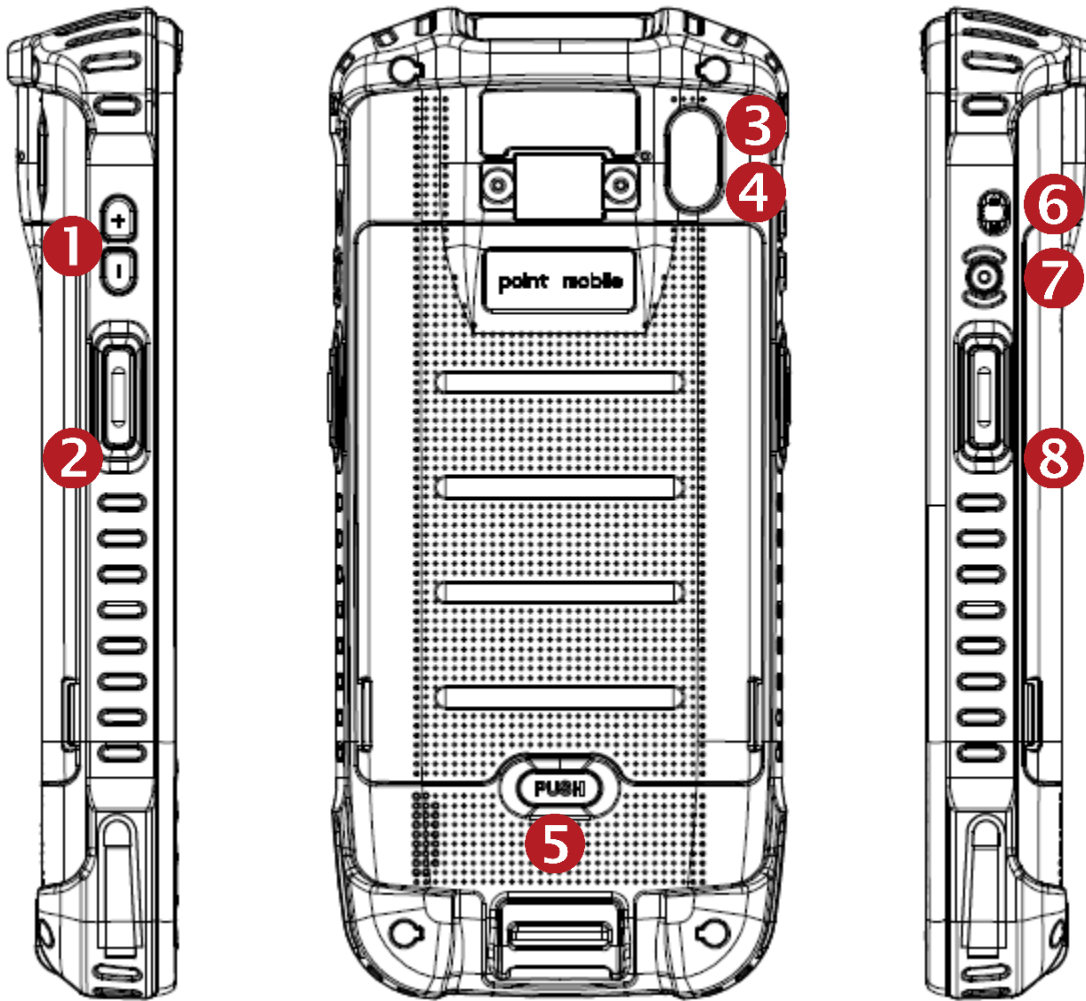

1. Volume Key
2. Scanner Trigger
3. Flash Light
4. Camera
5. Battery Cover Lock
6. 3.5mm Audio Jack
7. Power Key
8. Scan Trigger Key

---

# Accessory

AC/DC adapter



---

# Getting Started

Plug (US/ EU/ UK)



LCD protection film



Li-ion battery



# Setup PM66

## Getting Started

### Remove the Battery Cover

1. Press “Battery Cover Lock” button
2. Pull up the Battery Cover from bottom side area

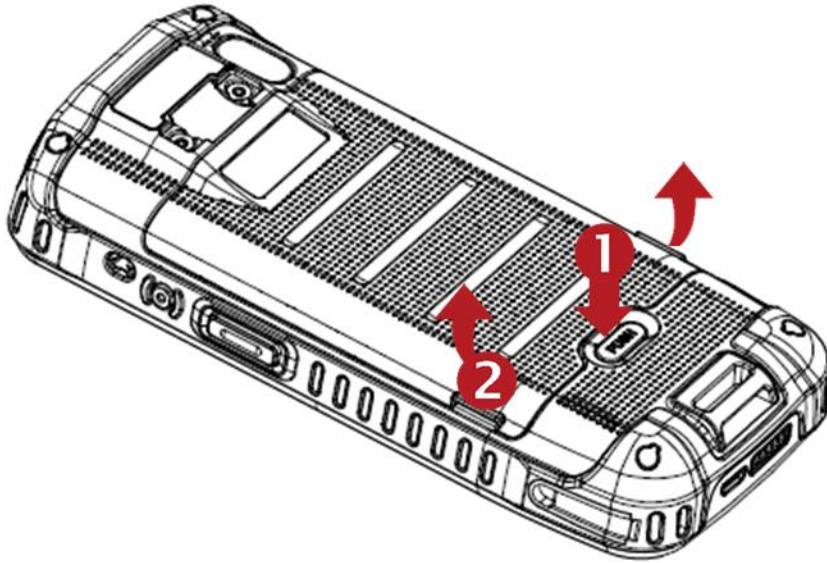

### Insert SIM card

1. Insert the SIM card into the slot. (Gold contact should face down)
2. To remove the card, gently slide it out of the slot.

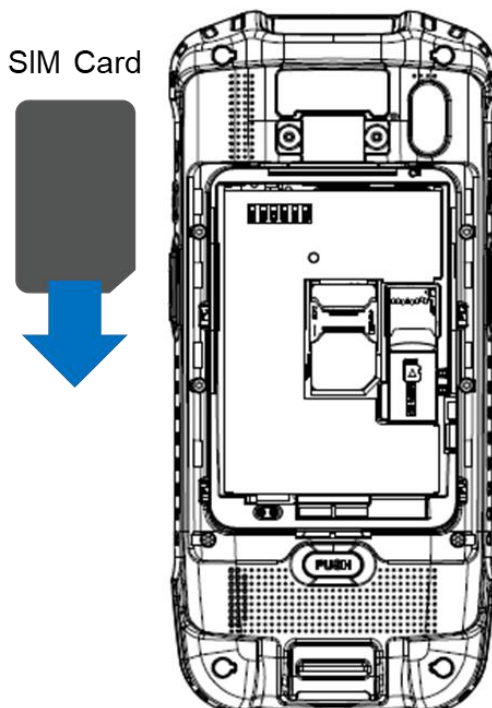

## Setup PM66

## Getting Started

**Note:** Your device only supports SIM cards. Do not attempt to insert other SIM types such as “Micro” and “Nano” SIM card, this may cause damage to your device. If you have to use different SIM card types, please use “SIM adaptor”.

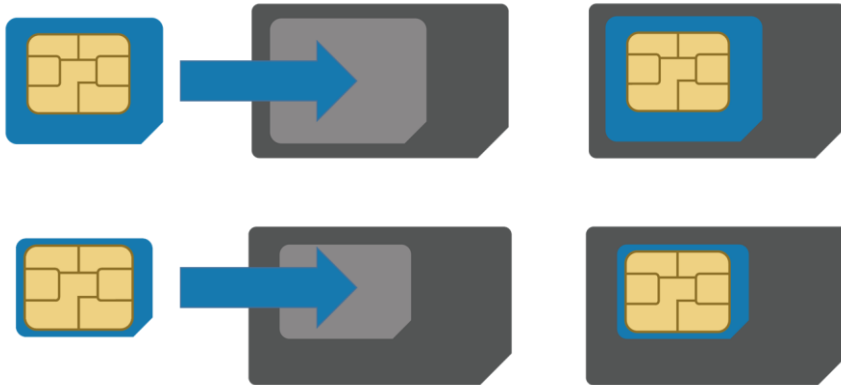

### Install and Remove the microSD card

1. Insert the microSD card into the slot (Gold contact should face down).
2. To remove the microSD card, gently slide it out of the slot.

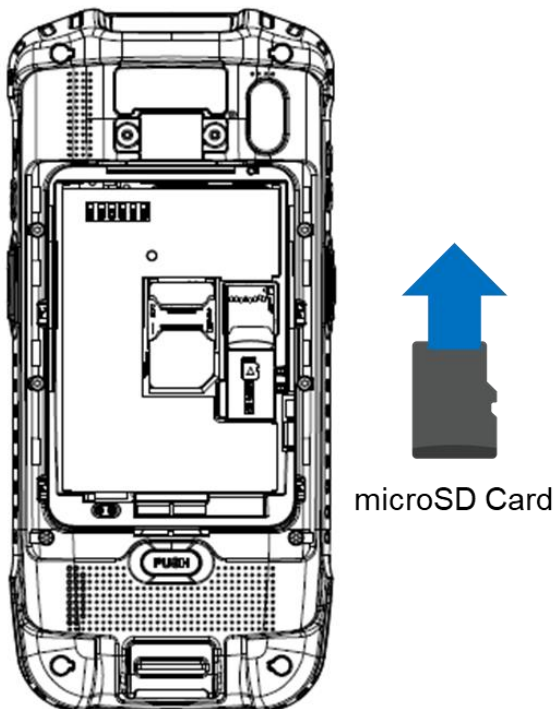

**Note:** To avoid data loss and SD card damage, please ensure the SD card is unmounted from Android system “**Settings – Storage - Unmount SD card**”



# Setup PM66

## Getting Started

### Insert the Battery

Insert "Battery" from top area first and then put in bottom area. Make sure battery contact "Battery Connector"

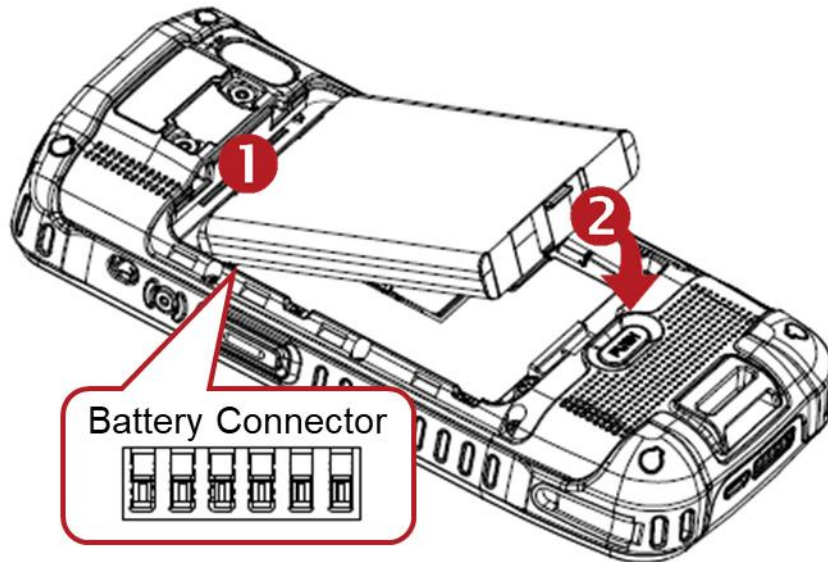

### Close the Battery Cover

Insert "Battery Cover" from the top area first and then put in bottom area. Press battery cover with both hand firmly

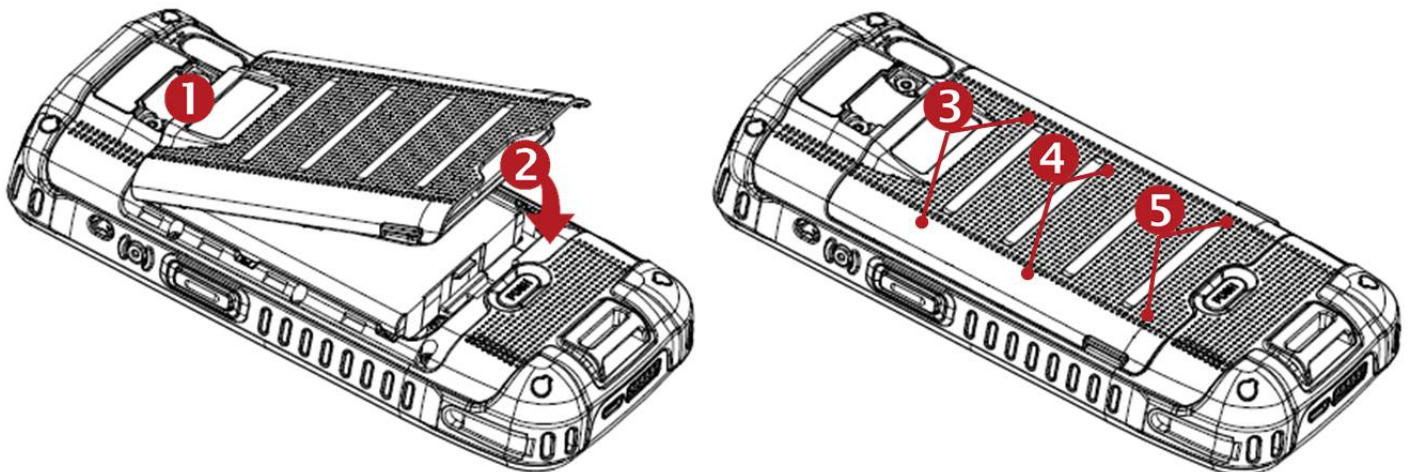

## Charge PM66

## Getting Started

1. Connect the AC/DC adaptor to your device and wall socket respectively

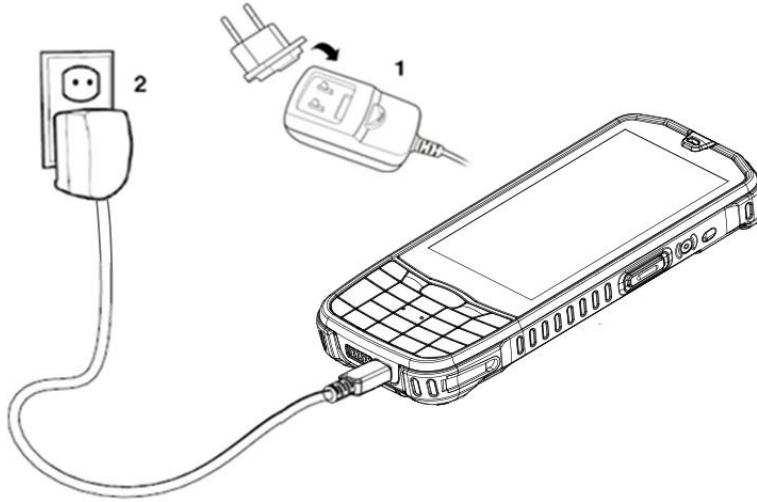

2. LED indicator will display charging status.

Steady Red	Battery is charging or Battery level is low
Blinking Red	Battery level is critical low
Steady Green	Battery is fully charged
Blinking Red and Green	Battery is removed or fail to recognize

### PM66 Battery Specification

Standard Battery	3.85V, 4,100mAh
Backup Battery	3.7V, 60mAh
Charging time	Standard Battery : About 6hours

**Note:** Always use an original charger and cable from the Point Mobile. Other chargers and cables may damage PM66. In addition, make sure connector, charger, cables are not wet.

## Turn On/Off PM66

### Getting Started

#### Turn On

1. Press and hold down the “Power Key” for a few seconds.
2. When PM66 enter to the boot mode, it will display “SMART BEYOND RUGGED” logo with short vibration
3. Release the “Power Key” and wait until PM66 finish booting

**Note:** If you cannot turn on your PM66, try below steps

- To turn on PM66, battery needs to be charged certain level. Please charge first
- Press and hold the “Power key” for 12 seconds to force reboot
- Press and release the “Reset Hole” and then turn on PM66 again

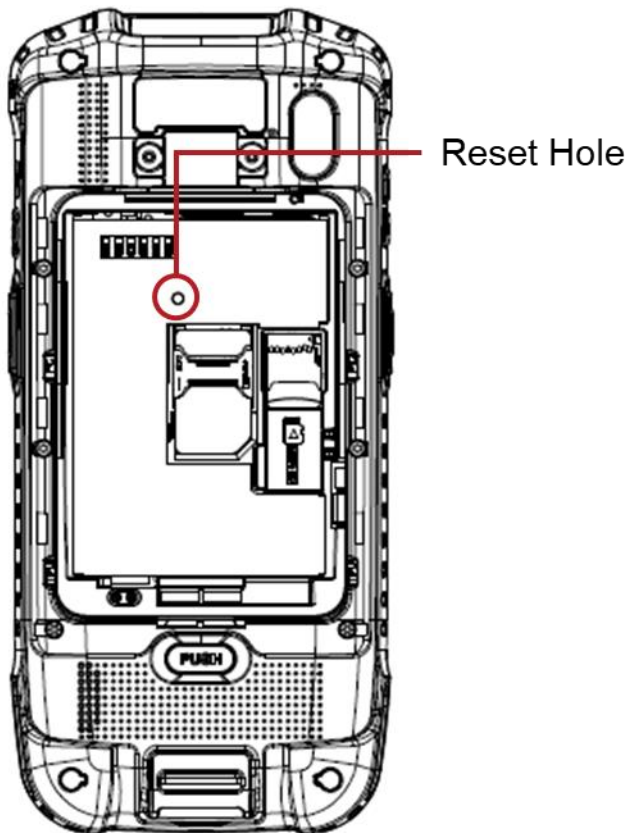

#### Turn Off

1. Press and hold the “Power Key” until you see the power menu
2. Among the menu, tap “Power Off”

## Hot swap the battery

### Getting Started

When battery level is low, you can replace the battery without turning off and on PM66.

- Remove the Battery and replace to another one.

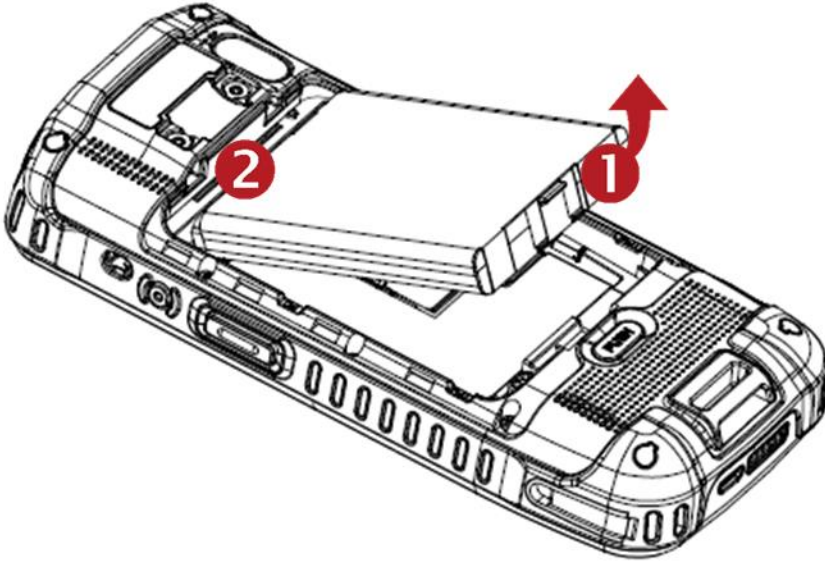

- Make sure the battery cover closed firmly.

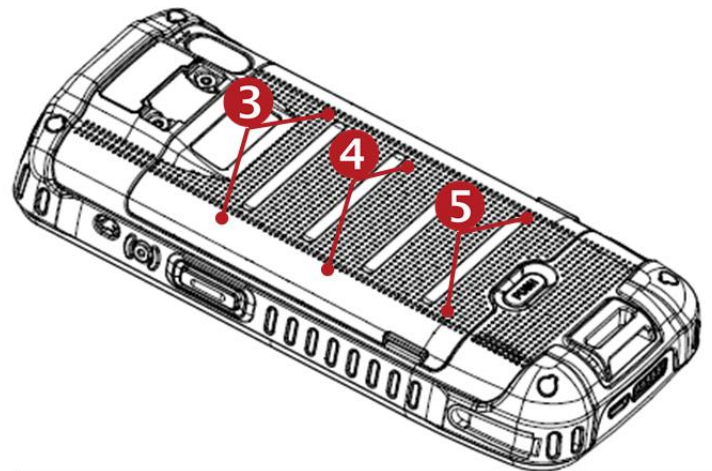
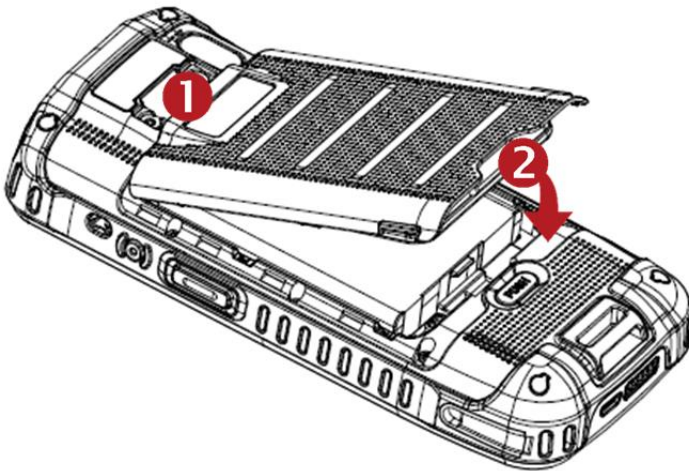

- Press the Power Key to use PM66 again.

# Use a keypad

## Learning the basics

### Power key

Press

- Lock the screen / Light up the screen.



Press and hold

- Display the power menu “Power Off / Reboot / Airplane mode”

Press and hold for 12seconds

- Forced to reboot

Press the “Power” key and “Volume Down” key together

- Screen capture

### Volume keys

In general



- Adjusts the ringtone volume or “Mute” the ringtone of an incoming call.

In call mode

- Adjusts the earpiece or headset volume.



In Music / Video / Streaming

- Adjusts the media volume.

In camera preview

- Take the photo by pressing Volume Up or Down key.

### Scanner Triggers

When “Scan Wedge” mode is activated

- By pressing, PM66 scan the barcode.

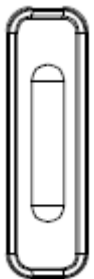

---

# Using a keypad

## Learning the basics

### Front panel (Touch Key)



#### Recent Apps key

- Press to see recently used apps.

#### Home key

- From any apps or screens, press to return to the Home screen.

#### Back key

- Press to go back to the previous screen, or to close a dialog box, options menu, notification panel, etc.

### Key Pad

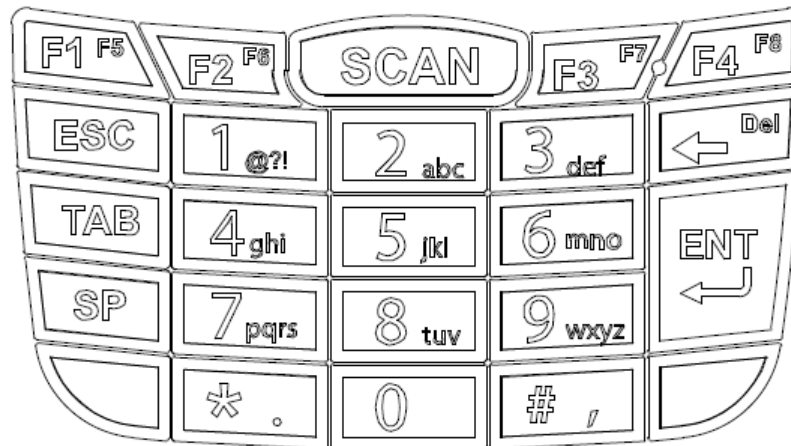

---

## Use a touch screen

### Learning the basics

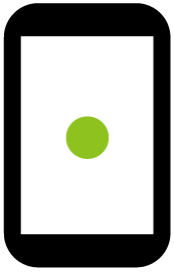

#### Touch

One-finger press

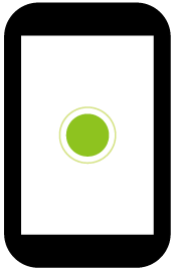

#### Double touch

One-finger press, lift, one-finger press, lift for "Zoom in"



#### Long press

One-finger press, wait, lift for "Select an item"

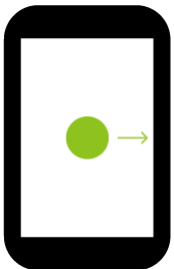

#### Drag, Swipe, or Fling

One-finger press, move, lift for "Scroll" or "Tilt"

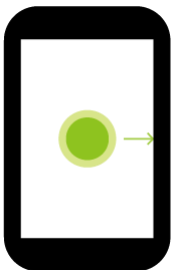

#### Long-press drag

One-finger press, wait, move, lift for "Pick up and move" or "select multiple items"

---

## Use a touch screen

---

### Learning the basics

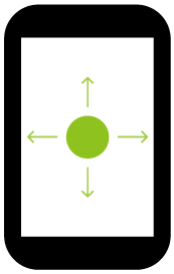

#### Scroll

Vertical or horizontal swipe in a single direction

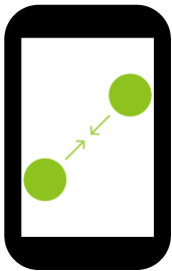
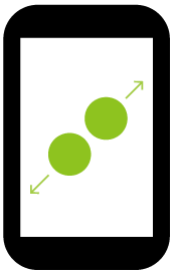

#### Pinch Open & Close

Two-finger press, move outwards and inwards, lift for “Zoom in and out”



#### Rotate

When PM66 is turning sideways, screen orientation is changing



# Home Screen, Apps and Widget

Learning the basics

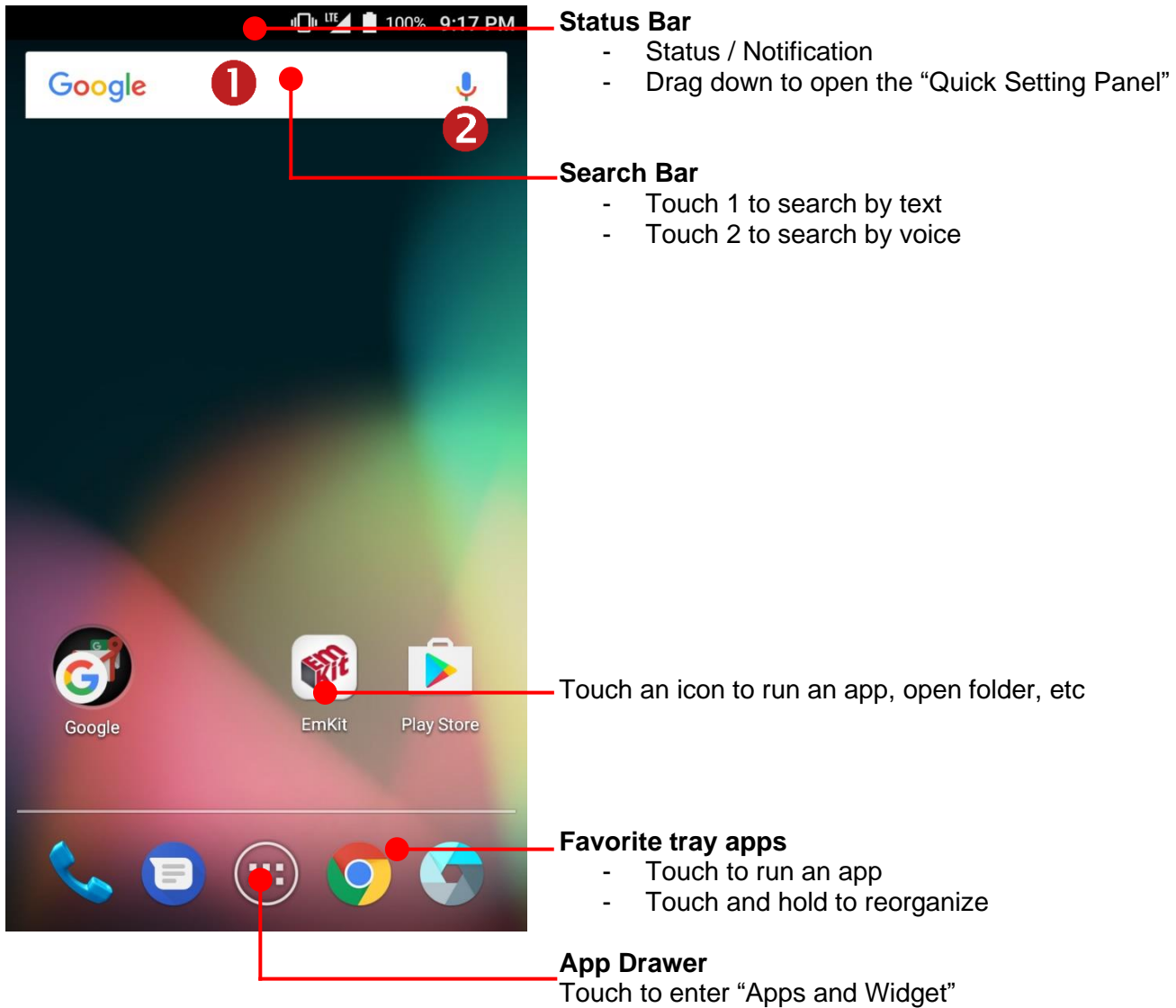

# Home Screen, Apps and Widget

## Learning the basics

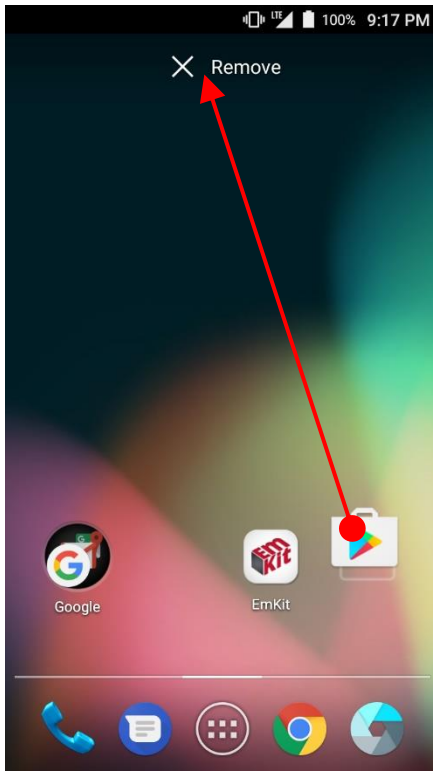

### Remove the app icon from home screen

- Long press the app icon and then drag it to the "Remove" area and then release

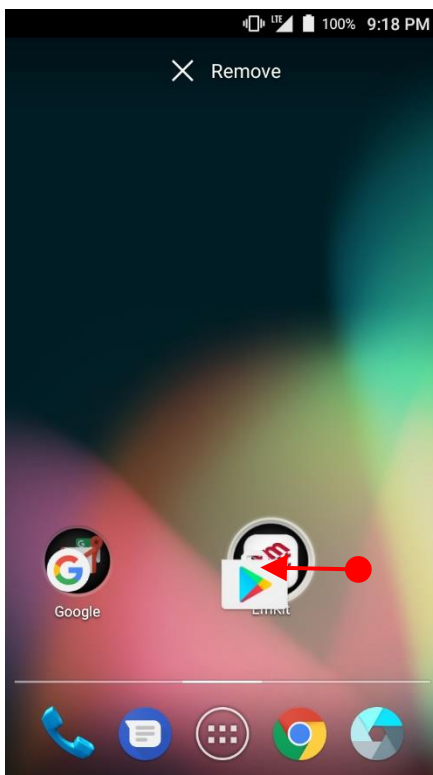

### Create "App Folder"

- Long press the app icon to other app icon. This will create the "App Folder"
- To set the folder name, touch the "Unnamed Folder" and rename it

# Home Screen, Apps and Widget

## Learning the basics

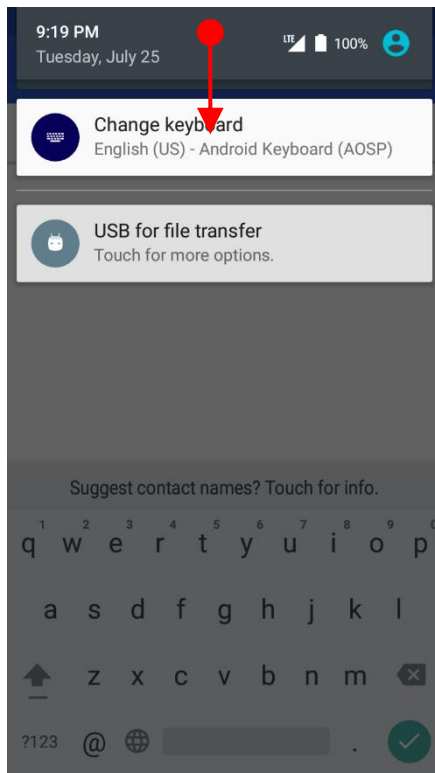

### Notification panel

When there are notifications from the Android (system) or the App, you can check details by drag down the “Status Bar”.

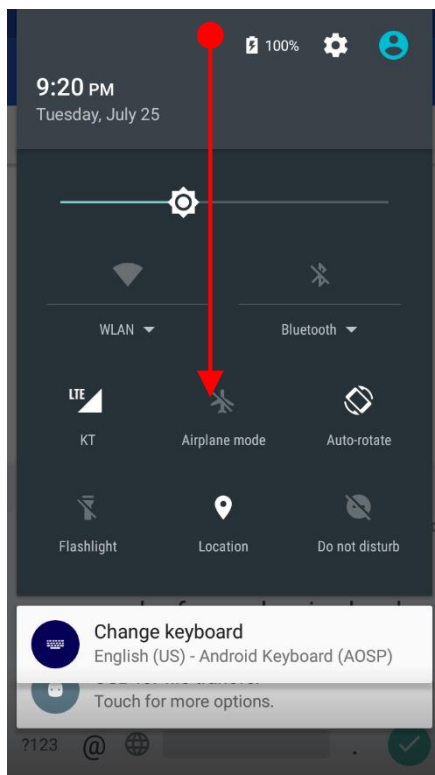



### Quick setting panel

You can access “Quick setting panel” by drag down the “Notification panel”. You can enable / disable functions or change modes easily.

# Home Screen, Apps and Widget

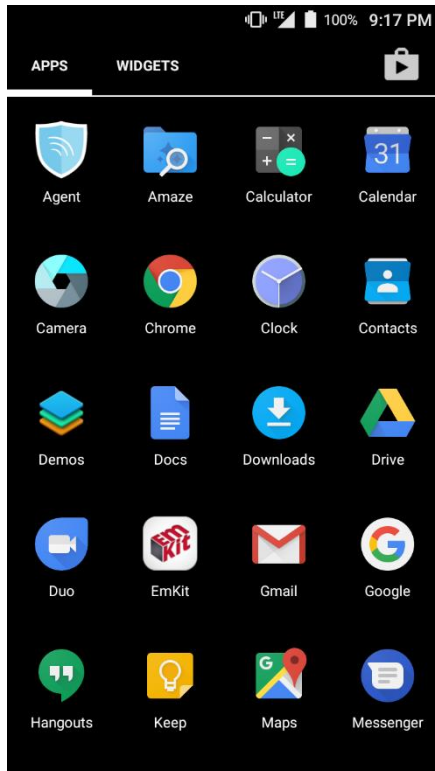
## Learning the basics



By touching the “App drawer” icon,  you can enter to the “Apps” and “Widgets”

All installed apps are listed in the “Apps” tab, alphabetically

- Tap app icon to run.
- Long press, specific app icon to place to the “Home Screen”.

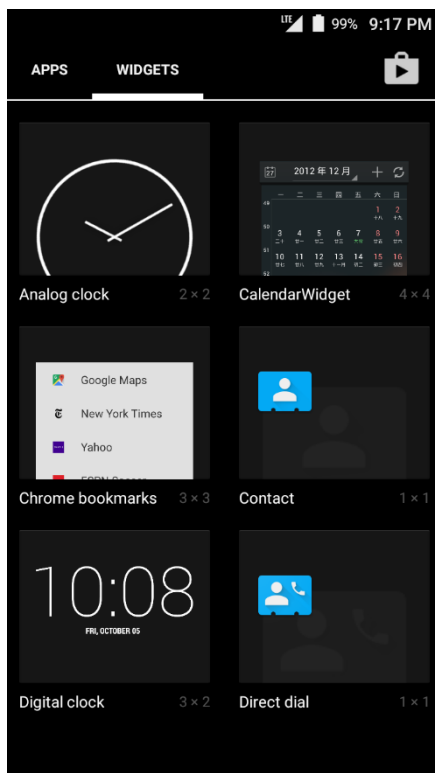





























All available widgets are listed in the “Widgets” tab, alphabetically.

- Long press, specific widget to place to the “Home Screen”.

# Status & Notifications Icons

Learning the basics













## Status icons

	GPRS connected		GPRS in use
	EDGE connected		EDGE in use
	3G connected		3G in use
	4G connected		4G in use
	Signal strength		No signal
	Roaming		Airplane mode
	No SIM card installed		
	WLAN is on		Connected to a WLAN network
	Bluetooth is on		Connected to a Bluetooth device
	Battery is full		Battery is partially drained
	Battery is low		Battery is very low
	Battery is charging		
	GPS is on		Alarm is set
	Speaker phone is on		Headset connected
	Vibrate mode/ Mute		Phone mic is mute

# Status & Notifications Icons

Learning the basics

## Notification icons

	Missed call		New SMS or MMS message
	New Email		Connected to VPN network
	Upcoming event		Screenshot captured
	Preparing SD card		SD card removed, unexpectedly
	OTG device connected		
	File uploaded		File downloaded
	There are more notifications		Other input method available

# Make a call

## Learning the basics

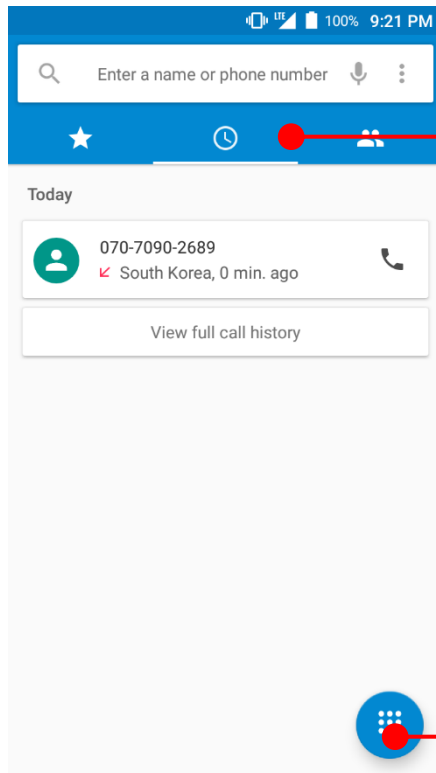

Touch  icon in the Favorite tray apps

Slide to access the "FAVORITE", "RECENTS" and "CONTACTS".

- To make a call from recent call list or missed call, select "RECENTS" tab
- To make a call from your contact list, select "CONTACTS"

Touch to use a dialer

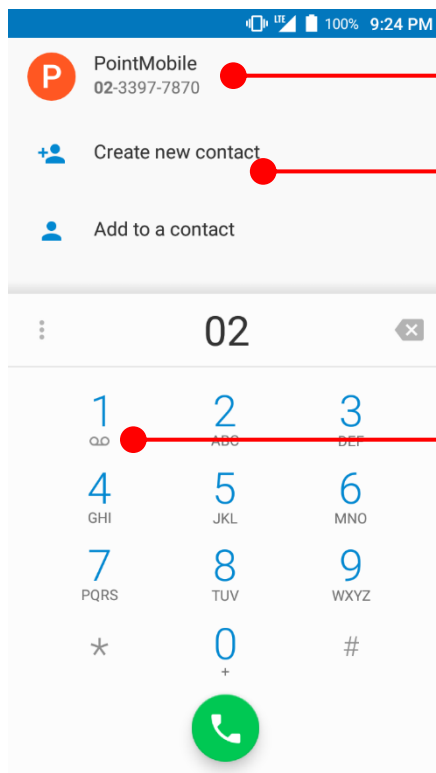

Suggested phone number(s)

Phone number can be saved to "CONTACTS"

Touch and hold the dial pad #1, to access voicemail.

## Make a call

### Learning the basics

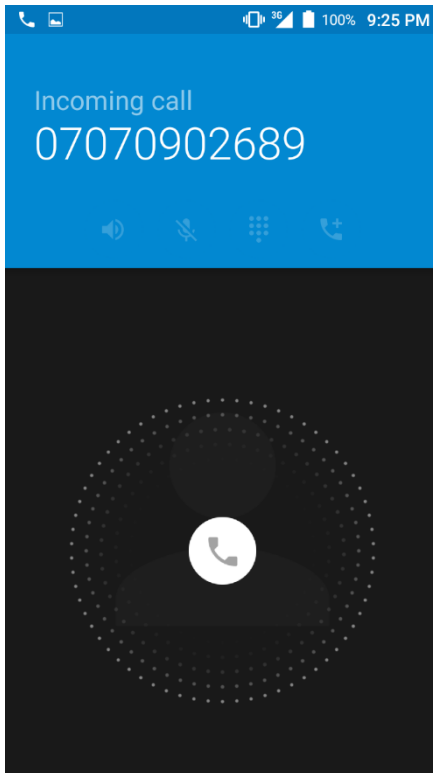

You can answer or rejecting a call by sliding the phone icon

Slide the  icon to the right direction in order to answer the call

Slide the  icon to the left direction in order to reject the call

Slide the  icon upwards to reject the call and send a preset message to the caller.



**Tip:** To mute the ringtone volume of an incoming call, keep press the “Volume down” key or turn your PM66 over.

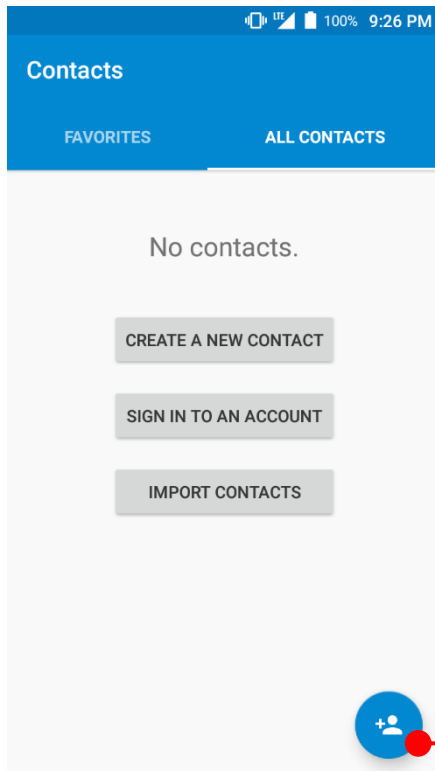

# Add to a contact

## Learning the basics



Touch  "App Drawer" icon and then  icon

### CREATE A NEW CONTACT

- You can manually create the new contact

### SIGN IN TO AN ACCOUNT

- You can sync with your contacts in the Google account.

### IMPORT CONTACTS

- You can import contact in the storage (.vcf file) or SIM card

Touch to add a new contact

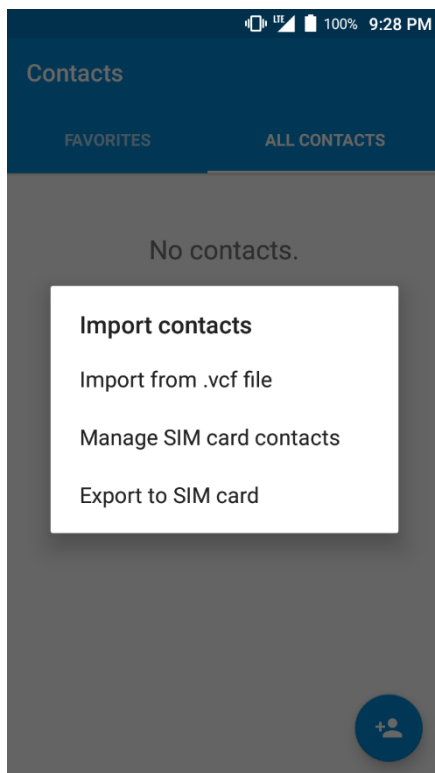

# Send a message

## Learning the basics

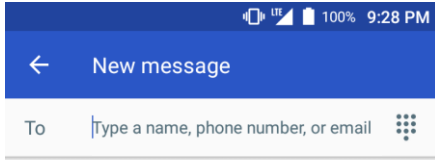

Touch  icon in the Favorite tray apps

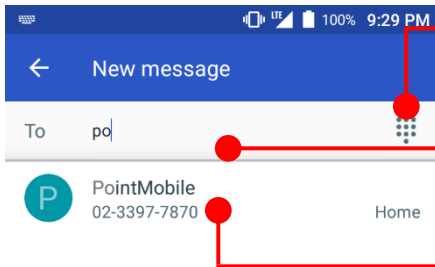

Touch to use a dialer

Touch to type a name, phone number or email

Suggest contact display here. Touch “Contacts” to compose a message

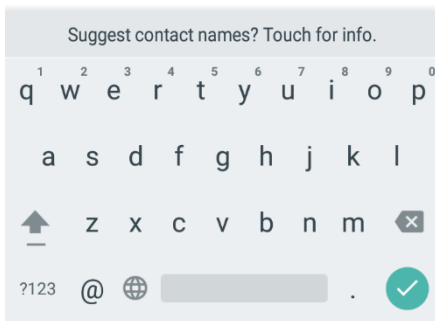

# Send a message

## Learning the basics

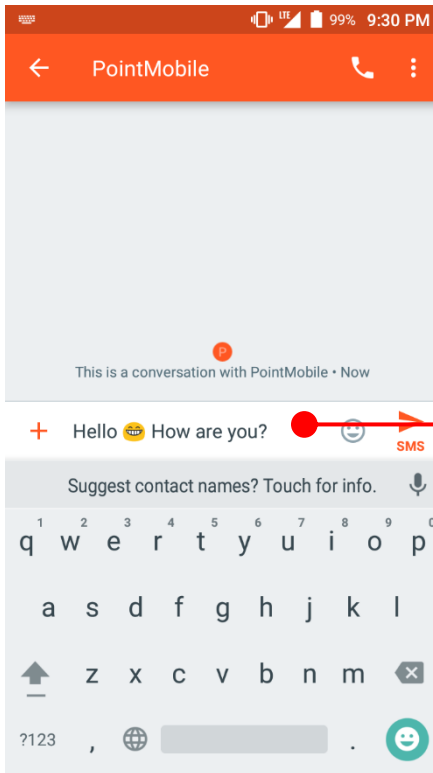

Your message display here

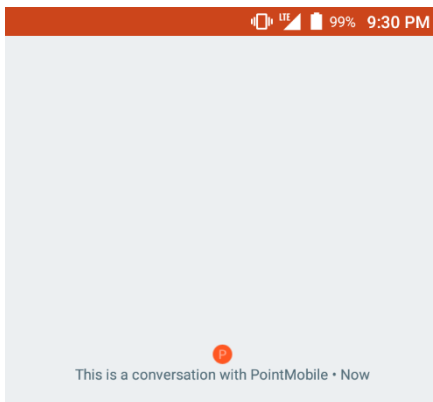

Touch to send the composed message

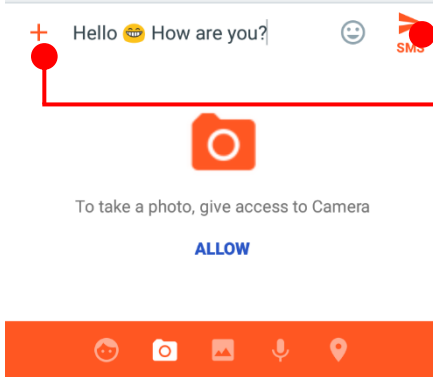



You can attach photo, saved picture, voice or location

**Note:** You may allow granting “Message App” access specific app or service.

# Connect to your Wi-Fi network

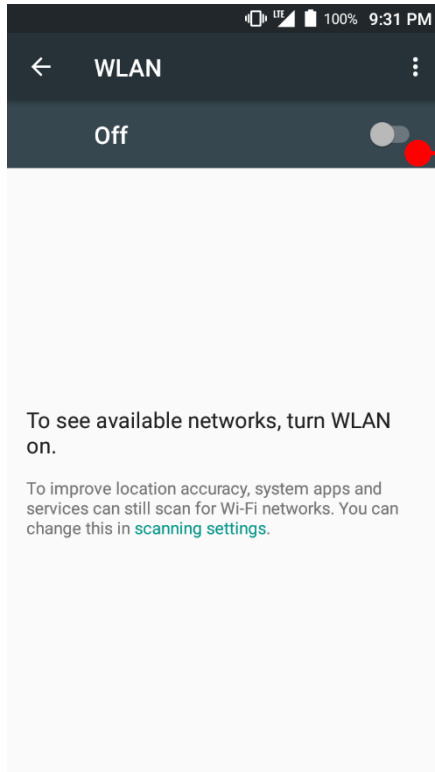
## Learning the basics



Touch  "App Drawer" -  "Settings" and then "WLAN"

Touch to turn On / Off the W-Fi

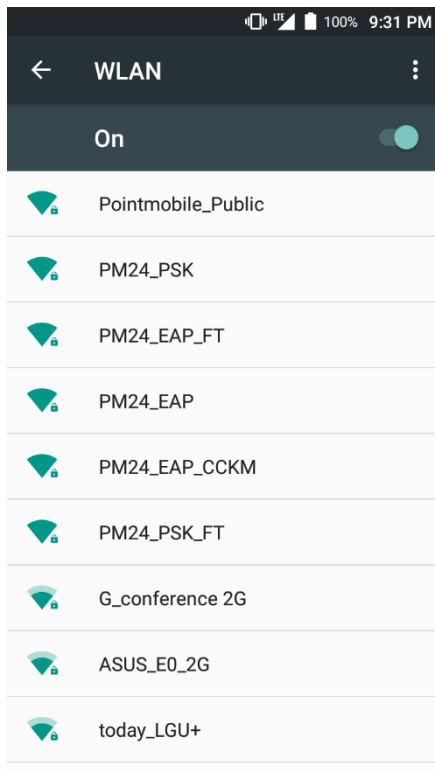

You can see nearby Wi-Fi network. Each AP's SSID information listed by signal strength



Icon means: Open Wi-Fi network. You don't need to enter the password



Icon means: Secured Wi-Fi network. To connect this Wi-Fi, you need to enter the password

# Connect to your Wi-Fi network

## Learning the basics

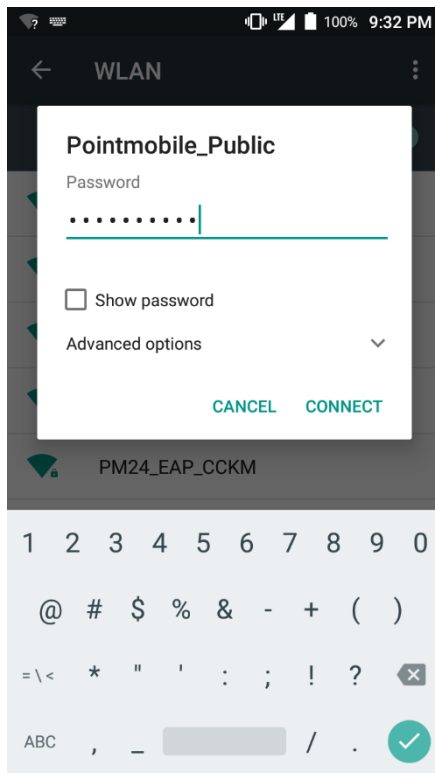

Touch SSID, which you want to connect.  
To connect to secured network, enter the password

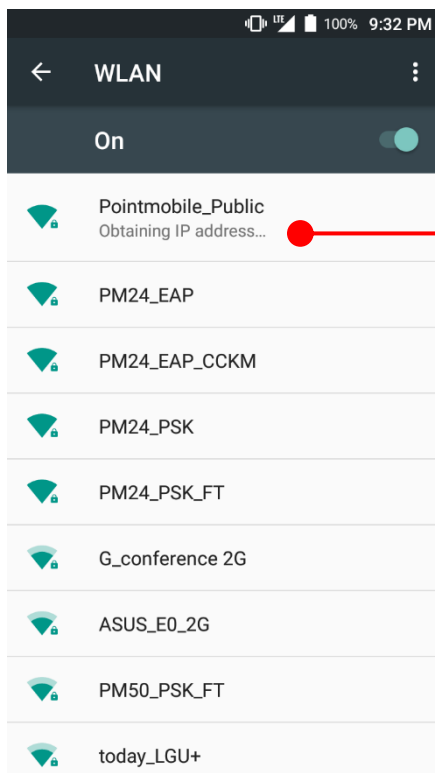



Your PM66 is obtaining the IP address from selected AP

# Use a Scanner

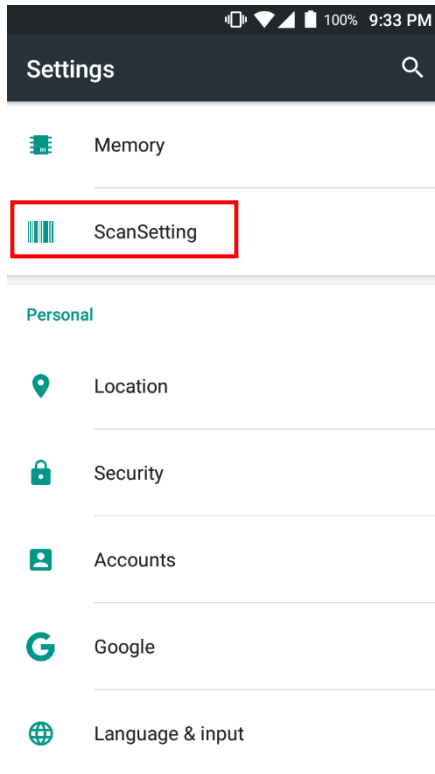
## Scanner Settings



Default setting of Scanner is “Off”  
To use the Scanner,

- Touch  EmKit and then “ScanSetting”
- Touch  “App Drawer” -  “Settings” and then “ScanSettings”

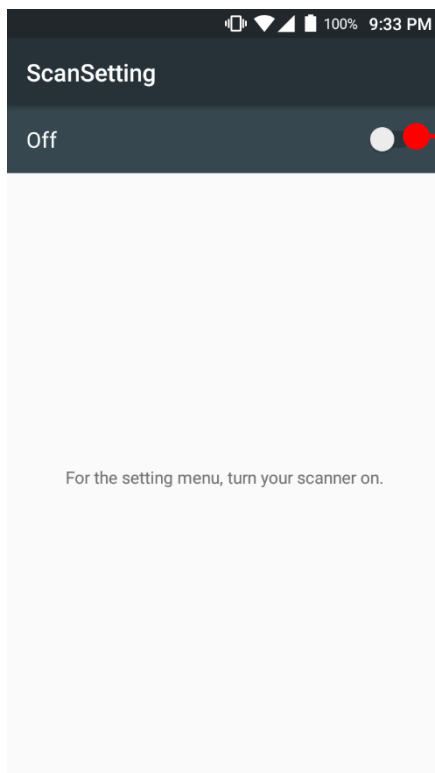

Touch to turn on the Scanner

# Use a Scanner

## Scanner Settings

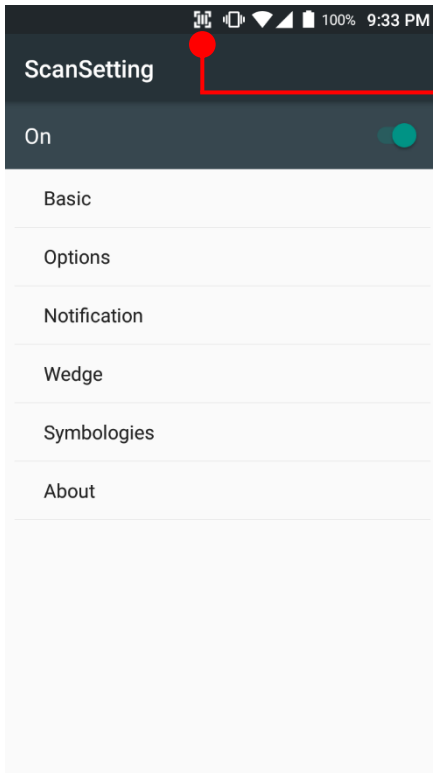

Now you can see “Scanner” icon in the “Status Bar”

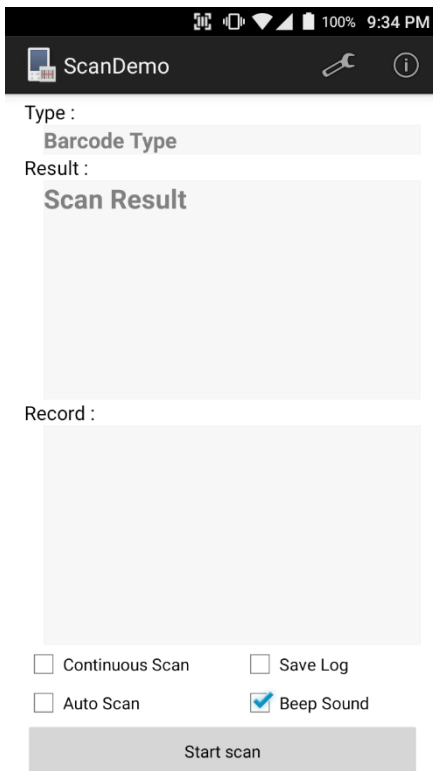

**Note:** When “Scanner” turned on, you can scan the barcode with “ScanDemo” in the EmKit

# Use a Scanner

## Scanner Settings

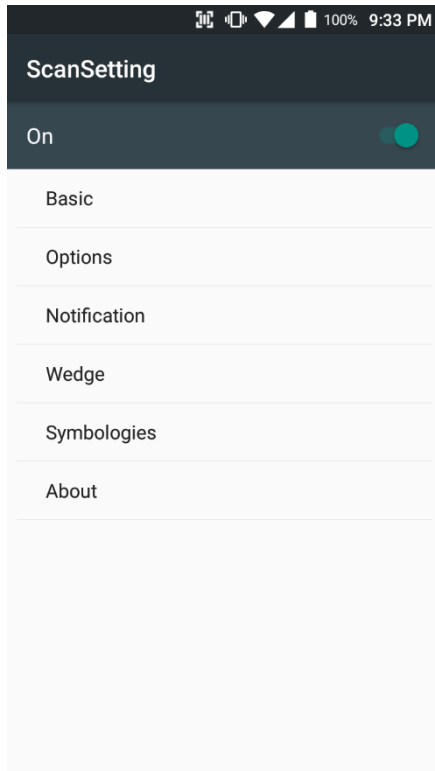

### Scanner setting details

Scanner setting consist with “Basic”, “Options”, “Notification”, “Wedge”, “Symbologies”, and “About”

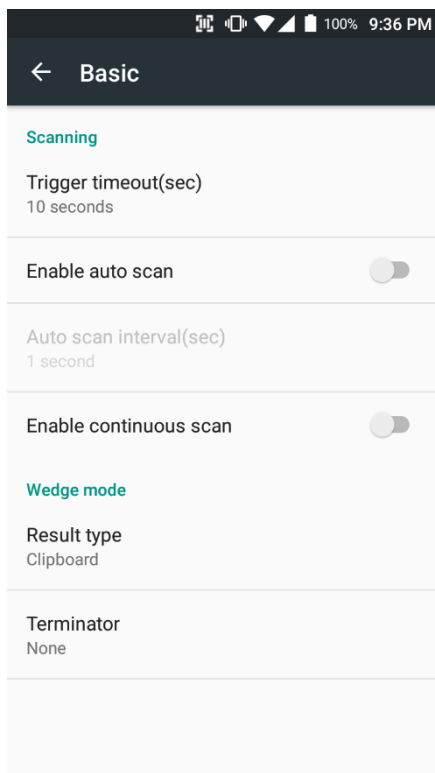

In the “Basic”, you can set “Scanning” option and “Wedge” mode option

In the “Scanning menu”, you can change Scanner’s trigger time out and set “Auto scan” & “Continues scan”

In the Wedge menu you can change, decode scan data’s result type handling “User Message”, “Keyboard Event”, “Clipboard’ or ‘Intent Broadcast’. Also you can set “Terminator” – “Space”, “Tab”, “LF” or “Tab & LF”



## Use a Scanner

## Scanner Settings

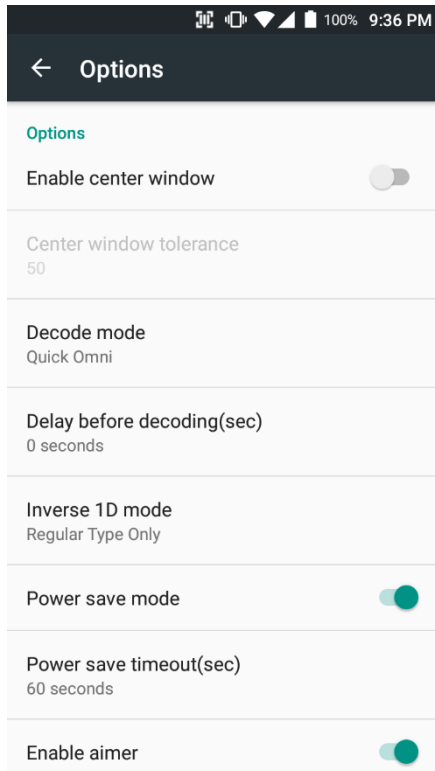

In the “Options”, you can enable / disable the “Center Window”, set “Decode mode”, “Power save mode” and enable / disable “Aimer” & “Illumination”

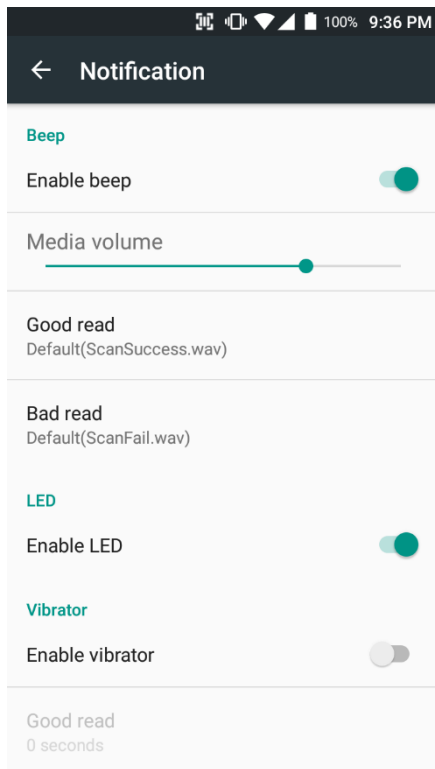

In the “Notification”, you can set notification option. You can change the volume level, notification sound, LED and vibration option

## Use a Scanner

## Scanner Settings

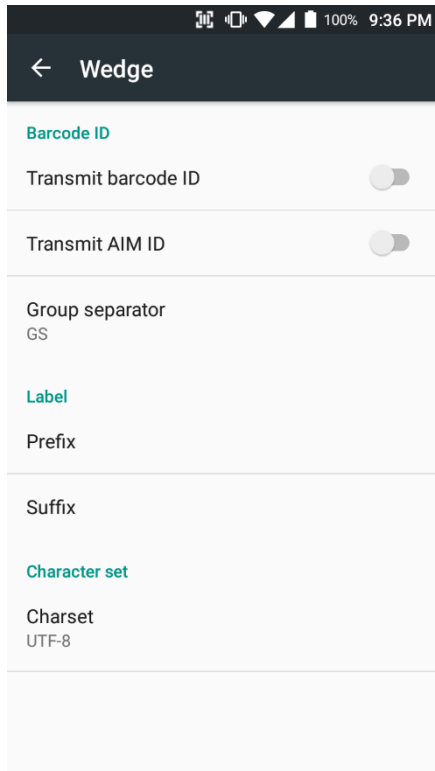

In the “Wedge”, you can enable / disable “Barcode ID” and “AIM ID”, set “Group separator”, “Prefix” & “Suffix” and “Character set”

## Use a Scanner

## Scanner Settings

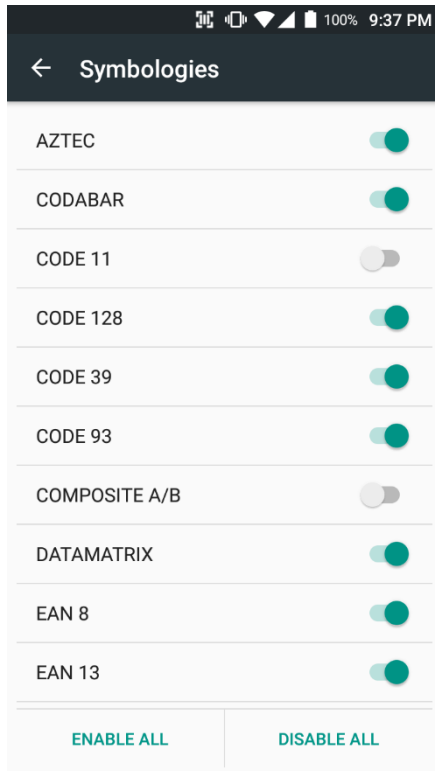

In the “Symbologies”, you can enable / disable specific barcode.

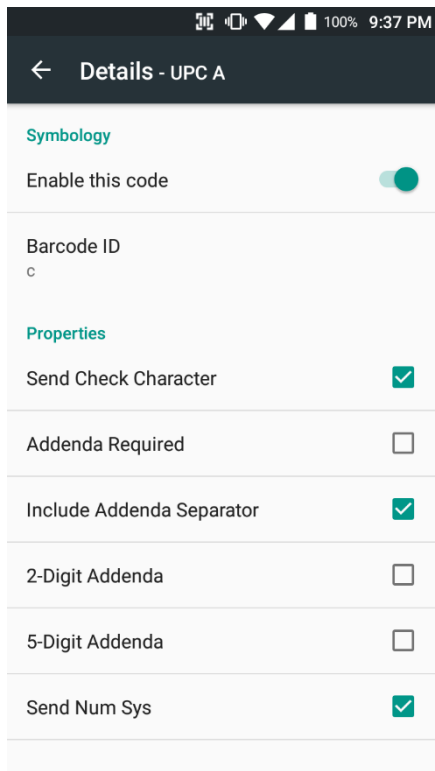

By touching each “Symbology” name, you can set detail option.

## Use a Scanner

## Scanner Settings

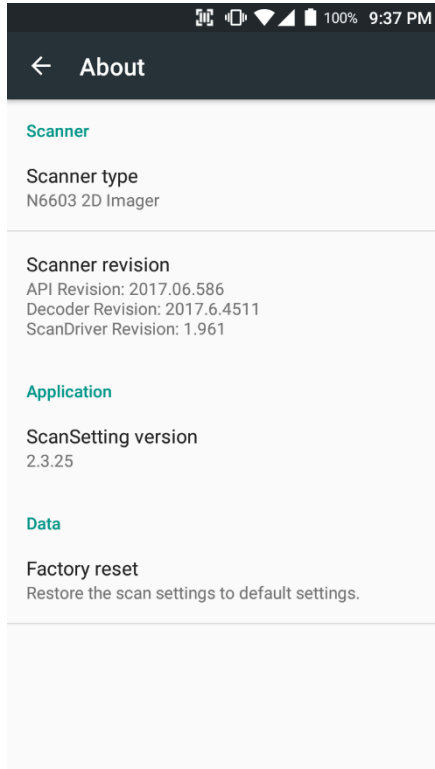

In the 'About', you can check your Scanner's information and restore Scanner's settings to default

# Scan a Barcode

## Scanner Settings

### Example of good Barcode reading



Idle barcode scan  
Please aim the middle of barcode



Even you aim the barcode slightly upper or down area or angle is slightly tilted, you can read the barcode



## Scan a Barcode

## Scanner Settings

### Example of bad Barcode reading



If you aim the barcode wrong direction or tilt too much, you can't read the barcode

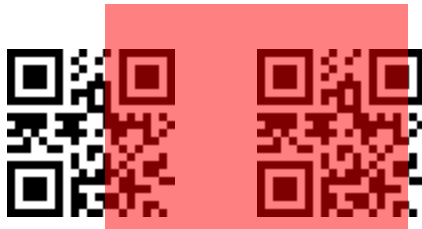

If you aim part of Barcode or aim two barcode together, you can't read the barcode

# OS Image update from a Storage

## OS Update

To update OS image, copy or place OS image file into the root folder of “Internal Storage” or “External Storage”

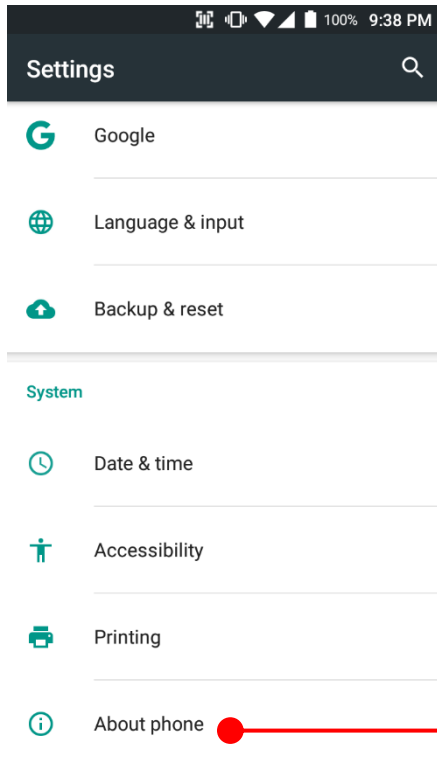

Touch  “App Drawer” -  “Settings” and then “About phone”

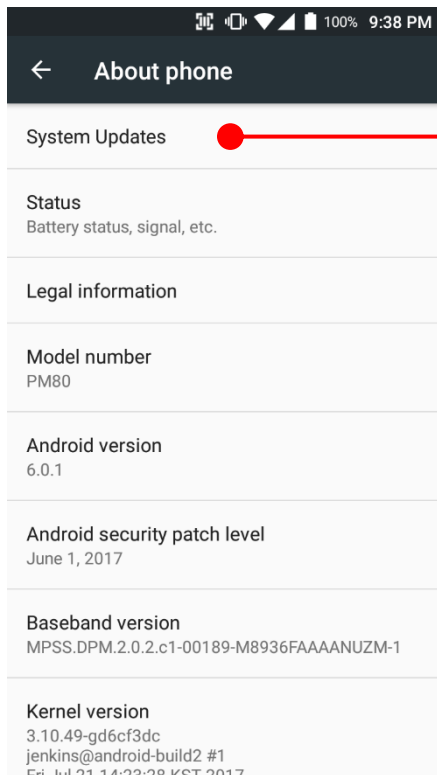

Touch “System Updates”

# OS Image update from a Storage

## OS Update

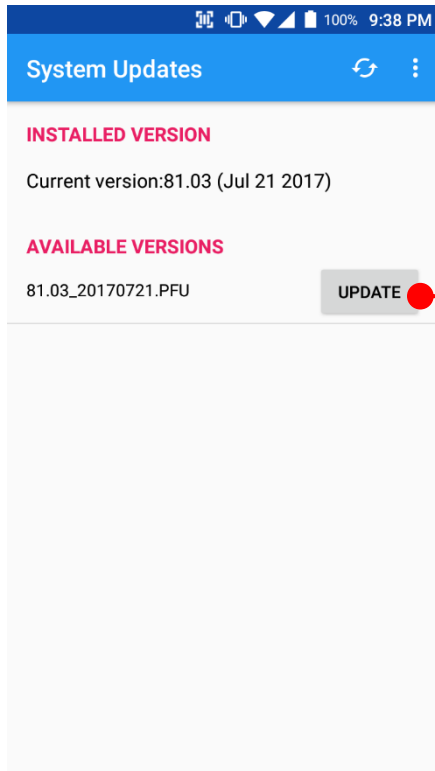

Your PM66 will check storage and display available OS image

Touch "Update" button

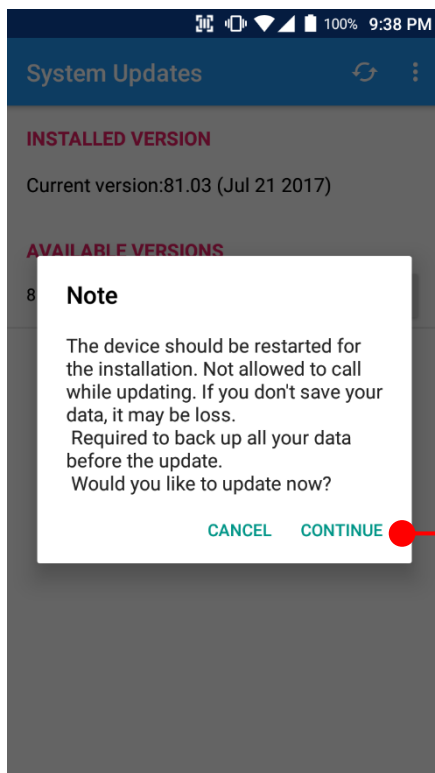



By touching the "CONTINUE" button, your PM66 start to update the OS image. During this time, you cannot use your PM66. Please save the data before start, the OS update process.

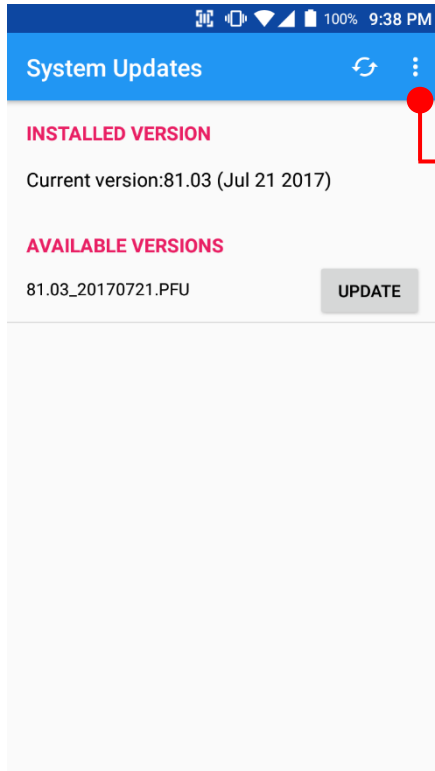

# OS Image update from the FOTA

## OS Update



Tap  icon for the advanced option

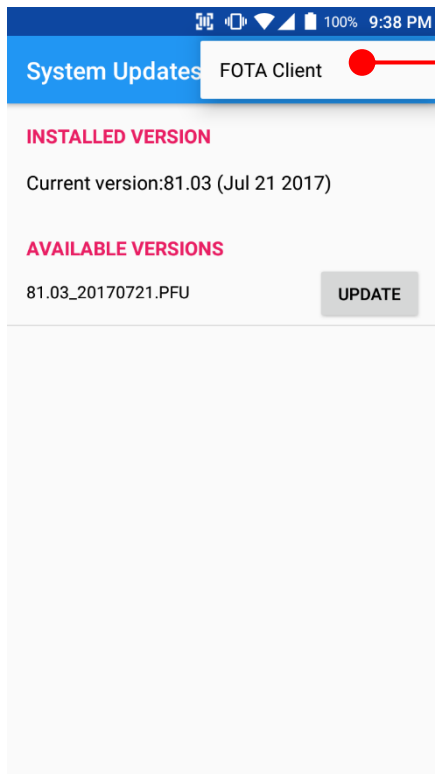

Touch "FOTA Client"

# OS Image update from the FOTA

## OS Update

PM66 will compare the OS image between FOTA server and current OS image. If there is newer OS image in the FOTA server, FOTA server will suggest downloading.

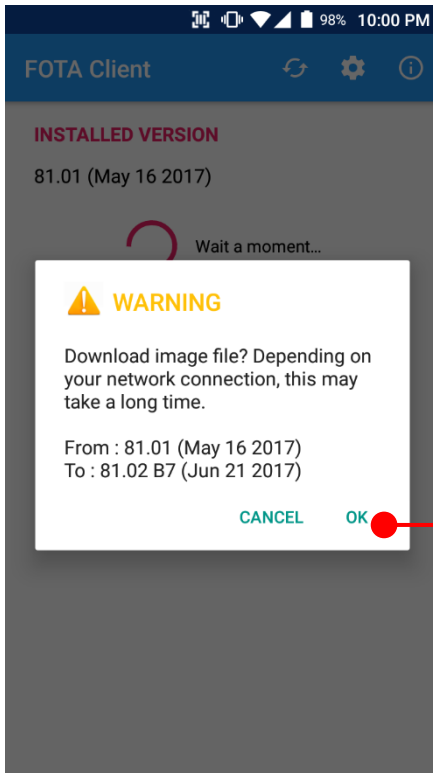

Touch "OK" to start download the image in the FOTA server

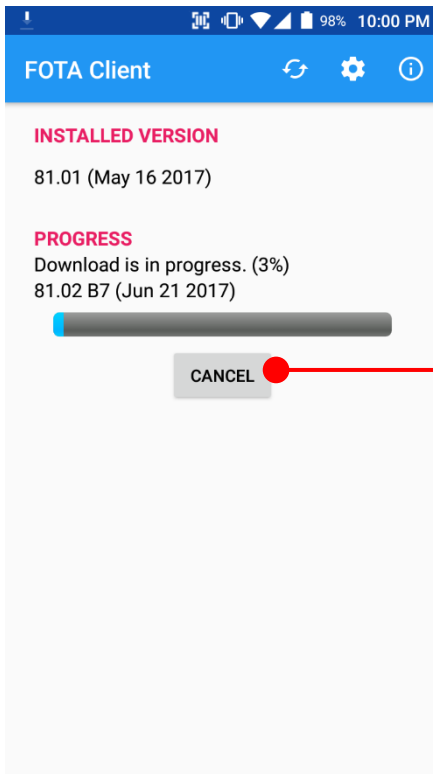

You can cancel OS image download process

**Note:** Default OS image download setting of FOTA Client is "Download over Wi-Fi only" Please connect to the nearby Wi-Fi network for FOTA service

# Factory data reset from Settings

## Factory data reset

When your PM66 system is unstable and abnormal behavior occur but could not recover by rebooting, you may need to “Factory data reset” your PM66

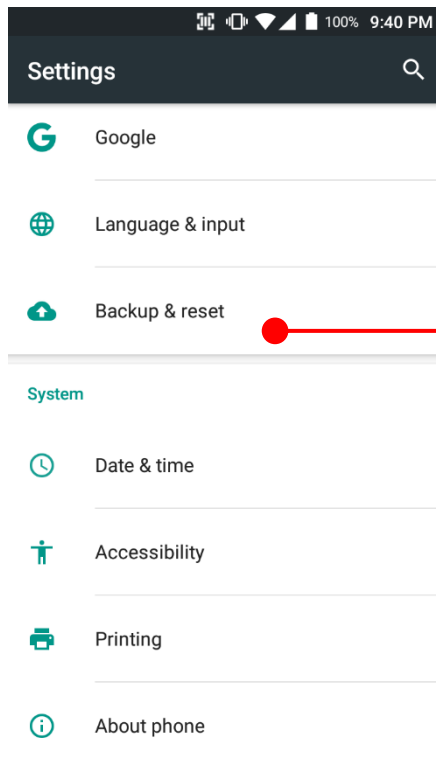

Touch  “App Drawer” -  “Settings” and then “Backup & reset”

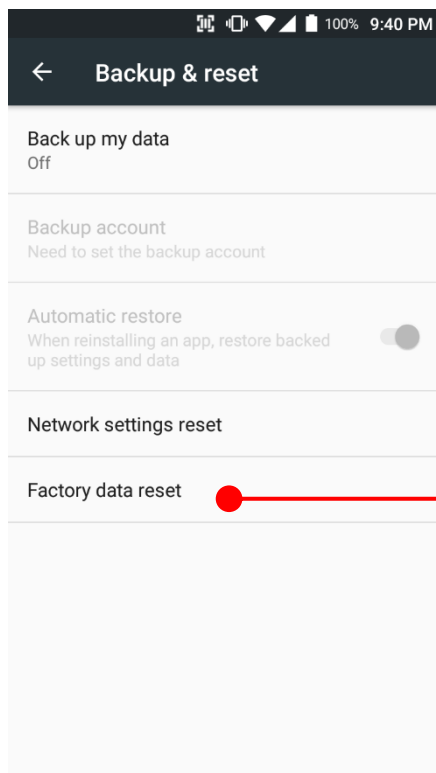

Touch “Factory data reset”

# Factory data reset from Settings

## Factory data reset

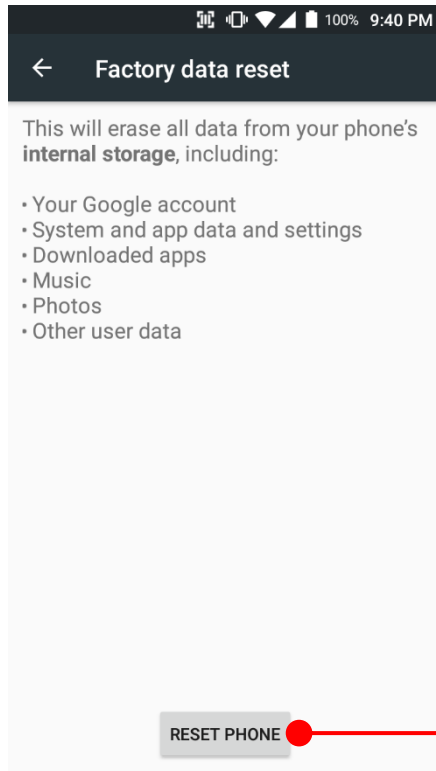

Please note, all apps and data in the internal storage will be deleted and restored to "Factory default" and this process cannot "Undo"

Touch to start "Factory Reset" process

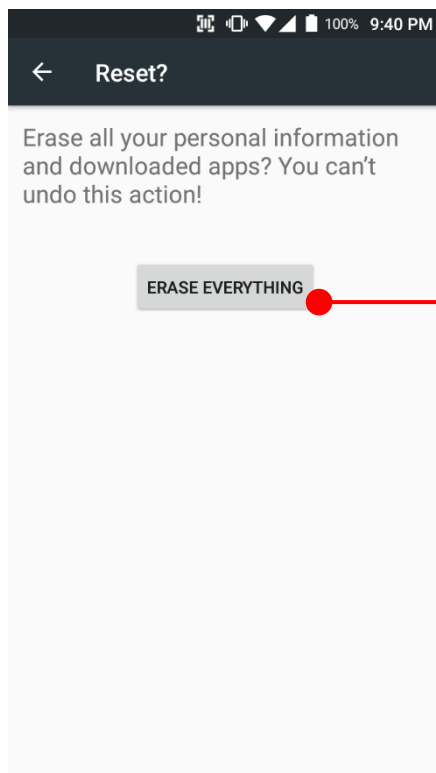

Touch to confirm erase of "Apps and Data"

## Force Factory data reset

## Factory data reset



### Force Factory data reset your PM66

You can perform “force” factory data reset your PM66. When your PM66 turned off, press “Power” + “Volume up” + “Home” button all together. After short vibration from your PM66, you may release the buttons.

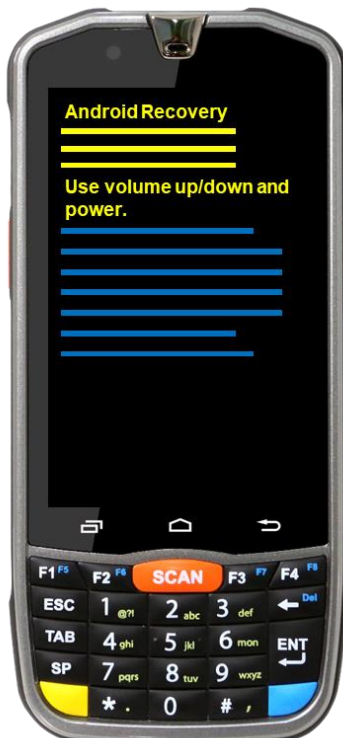

PM66 enter to the “Android Recovery” mode. In this mode, “Volume up” is “Move Up” in the menu tree and “Volume down” is “Move Down” in the menu tree. “Power Button” is “Select”

## Force Factory data reset

## Factory data reset

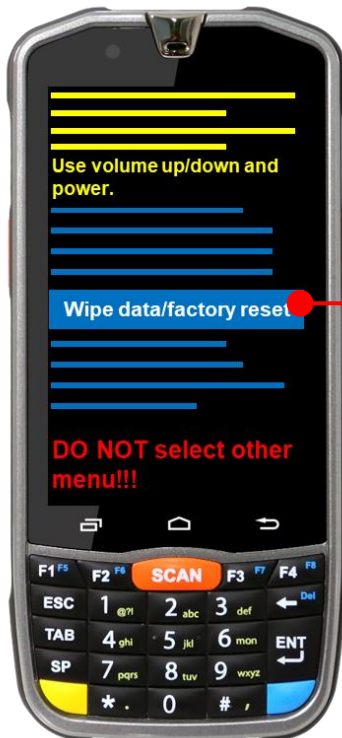

Select "Wipe data/factory reset"

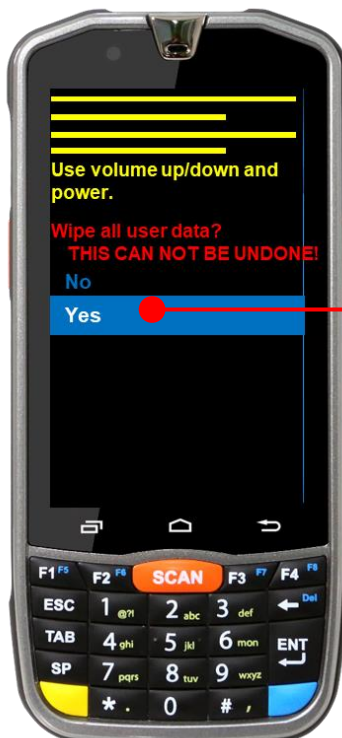

Select "Yes" to perform the "Factory data reset"  
After that, your PM66 start wiping the data

## Force Factory data reset

## Factory data reset



After data wiping, please select “Reboot system now” to finish the “Force Factory data reset” process

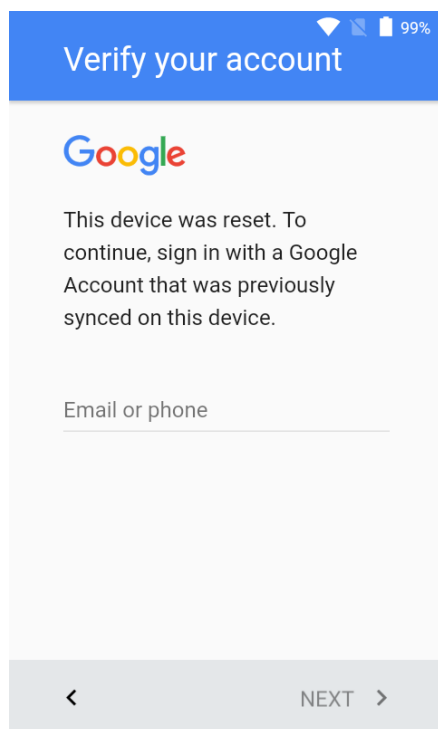

After Force factory reset, if PM Android Device locked by Factory Reset Protection, then please enter to Fast Boot mode and execute command

- fastboot erase config
- fastboot reboot

**Note:** Factory Reset Protection (FRP) is a security method that was designed to make sure someone can't just wipe and factory reset your device if you've lost it or it was stolen

# Enterprise Mobility Kit

EmKit

## Enterprise Mobility Kit – Truly, what Enterprise needs

Point Mobile announces new software solution – called “EmKit” is new software solution for enterprise mobility users. Our every Android device shall have EmKit pre-installed and every use can access them for free of charge\*. EmKit offers truly-value-added advantages, for enterprise users, which are against consumer-centric & non-customizable smartphones. Every solution in EmKit is 100% compatible with Point Mobile Android GMS certified devices.

\* Necessary MDM license subjects upon individual subscribers

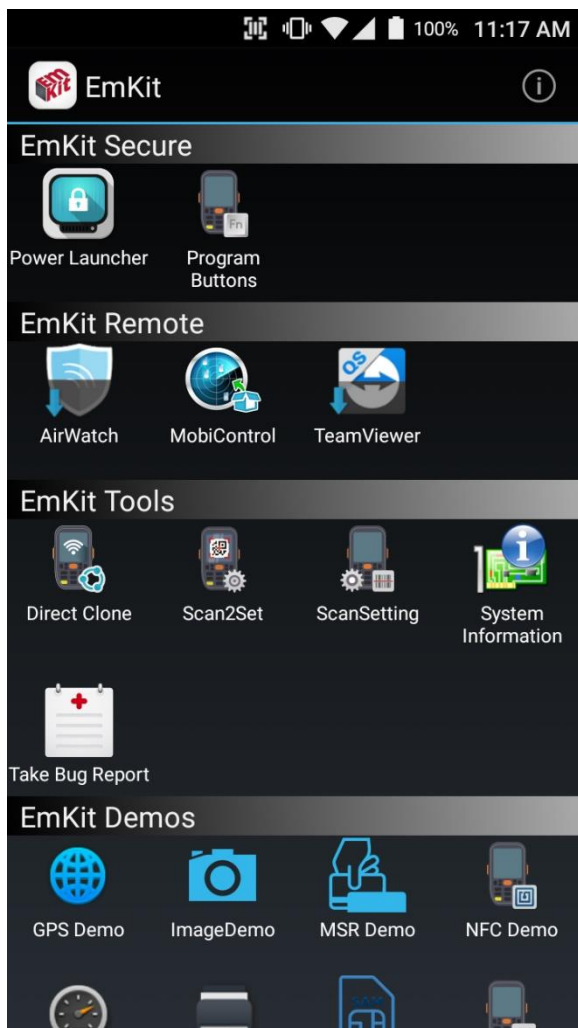

EmKit consist with “**EmKit Secure**”, “**EmKit Remote**”, “**Emkit Tools**” and “**EmKit Demos**”

- EmKit Secure “Lock Your Device”
- EmKit Remote “Mobile Device Management”
- EmKit Tools “Smarty Tools Ease Enterprise”
- EmKit Demos “Friendly For Programmers”



# EmKit Secure

EmKit

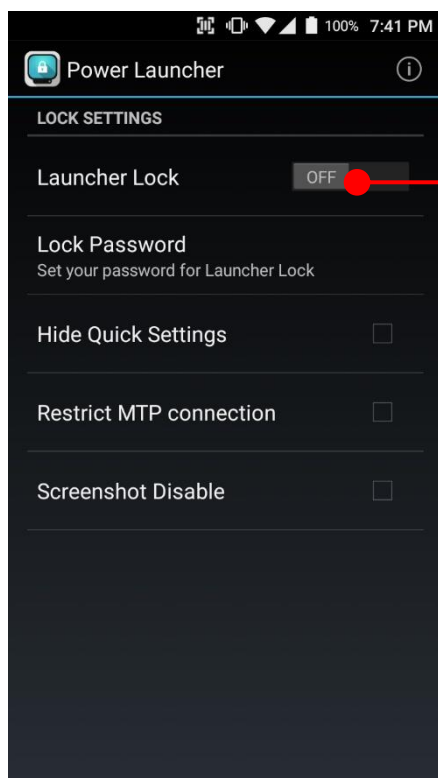

## Power Launcher

You can lock your Point Mobile Android model's **Home Screen** and limit to access app drawer or specific function. This function as known as **Kiosk mode**.

- Hide Quick Settings : Limit to access quick setting panel
- Restrict MTP connection : Limit to access Point Mobile Device's MTP connection
- Screenshot Disable : Disable screenshot capture in OS level

Restriction feature will be keep added.

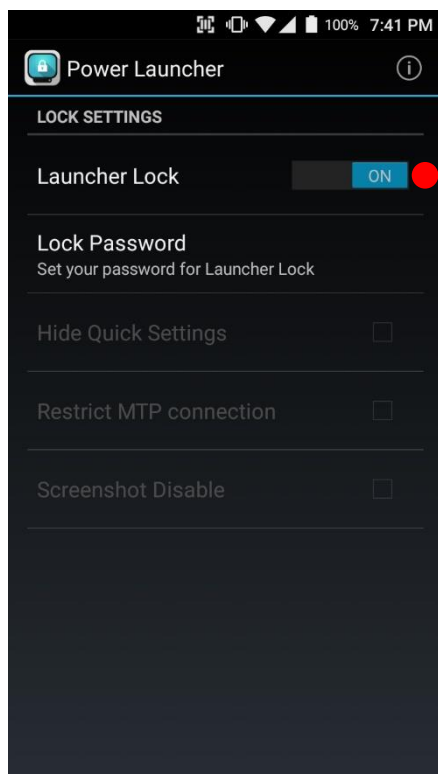

After restriction feature check, switch **Launcher Lock** to On.

# EmKit Secure

## EmKit

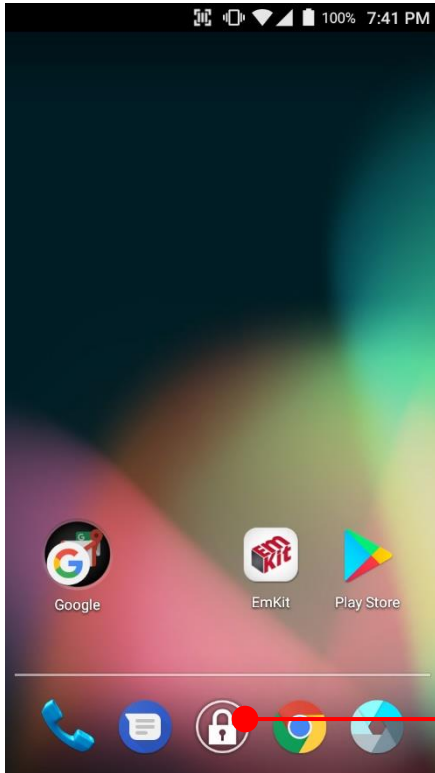

When Power Launcher is locked, operator could not access to **App drawer**.

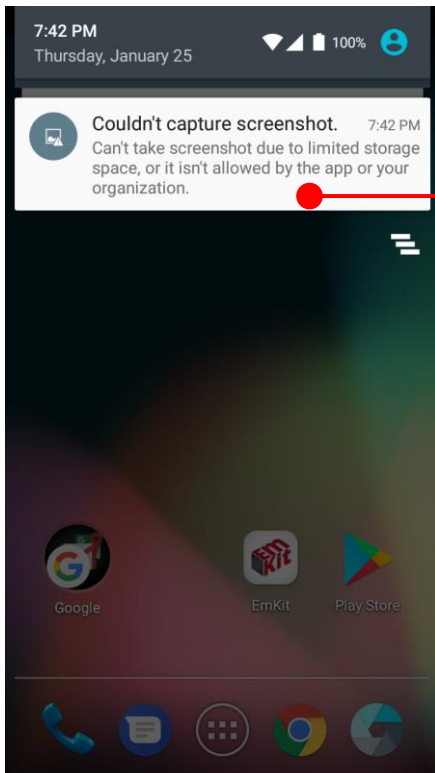

Example of **Screenshot Disable** restriction.

# EmKit Secure

EmKit

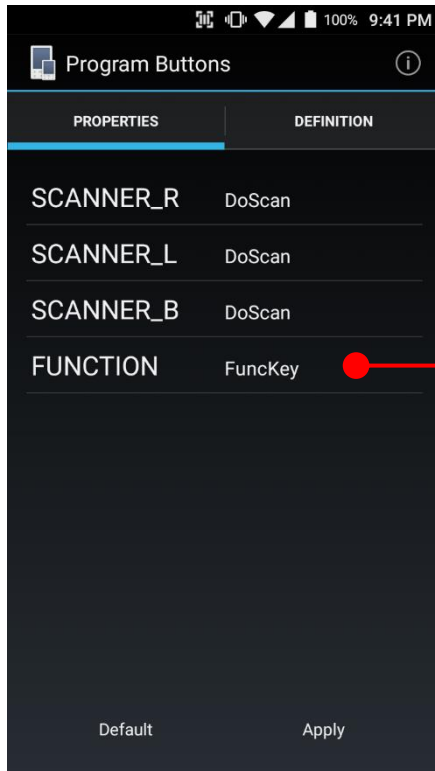

## Program Buttons

You can assign Hardware buttons function to rich pre-assigned functions.

Also you can applying the customized KCM file (Key Character Map Files) here.

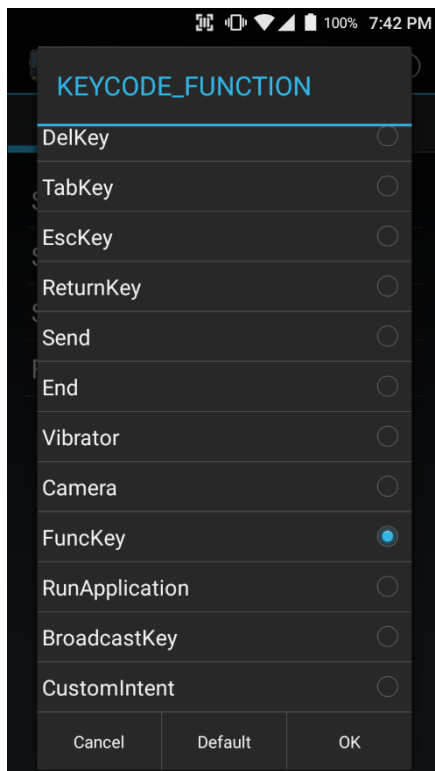

# EmKit Remote

## EmKit

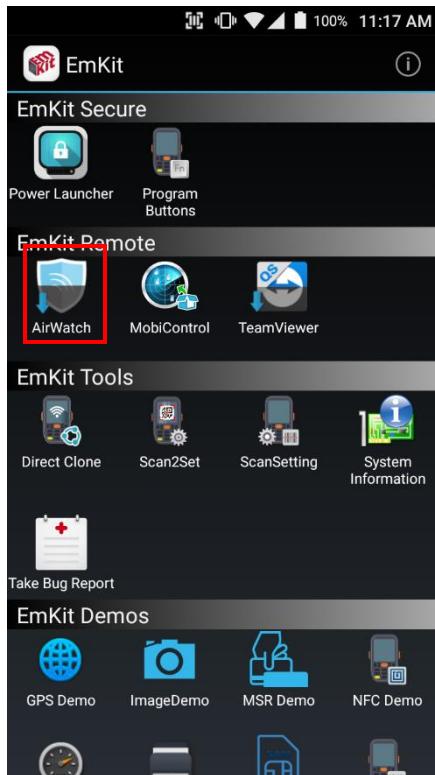

To install the AirWatch agent to Point Mobile Android device, please touch AirWatch icon

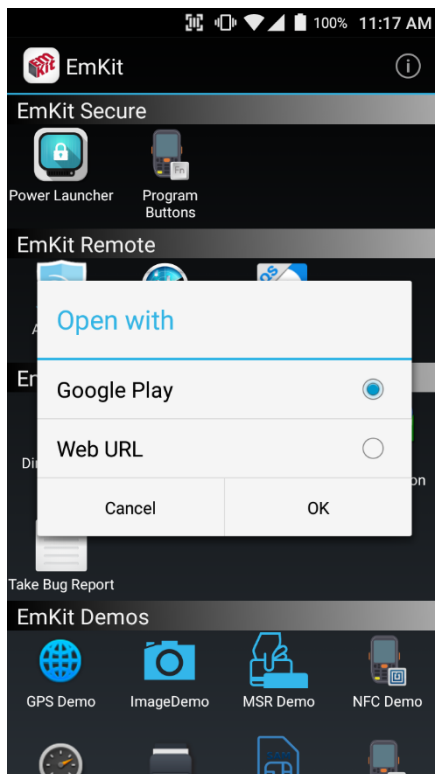

App provides AirWatch agent install via Google Play or Web URL.

- Google Play method requires Google account login. AirWatch agent download and install managed by Google Play
- Web URL method requires user's manual installation

## EmKit Remote

## EmKit

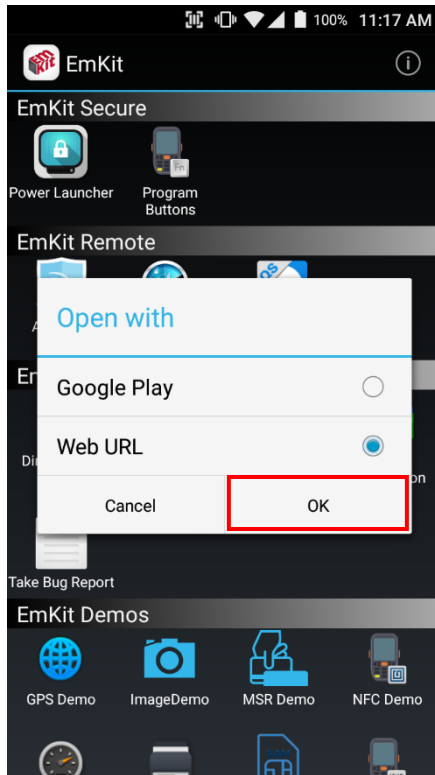

To install AirWatch agent from Web URL method, select Web URL and then **OK**

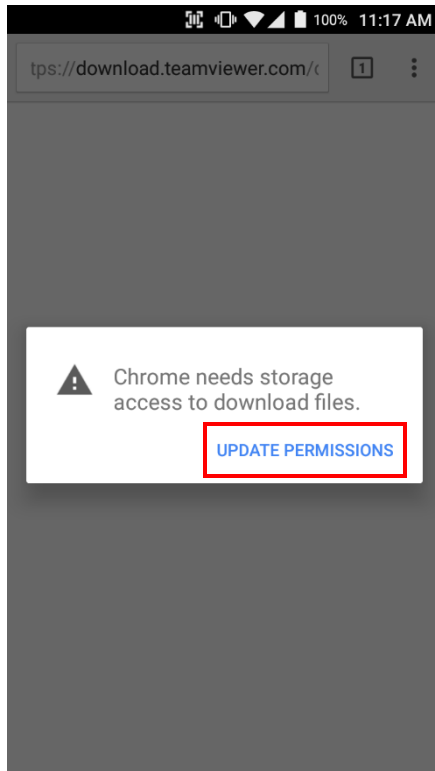

Web browser will download the apk file to the Point Mobile Android device. Before downloading, browser need permission to download apk file to the storage. Please touch **Update Permissions** button

# EmKit Remote

## EmKit

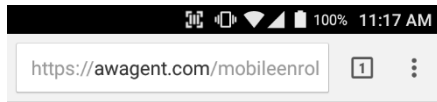

After permission update, web browser download the latest version of AirWatch agent apk file. Install this apk file to Point Mobile Android device.

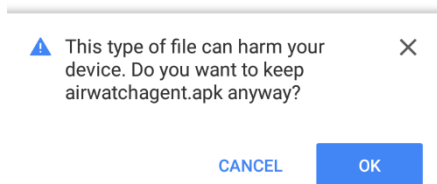

**Note:** If you need to install specific agent version, please contact to AirWatch

## EmKit Remote

## EmKit

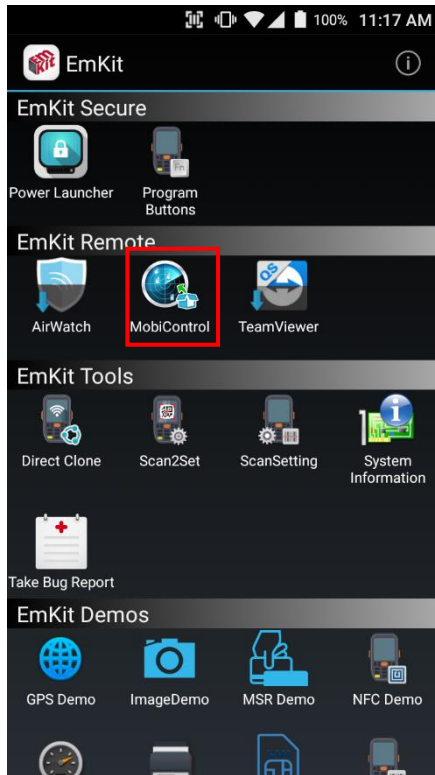

SOTI Mobi Control installer is pre-installed to Point Mobile Android device. To start enrollment process, please touch MobiControl icon

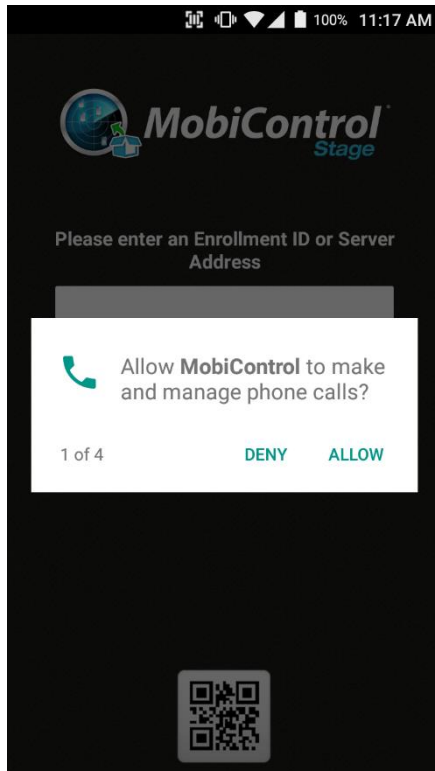

Mobi Control app request permission grant during enrollment process. Please allow it.

# EmKit Remote

## EmKit

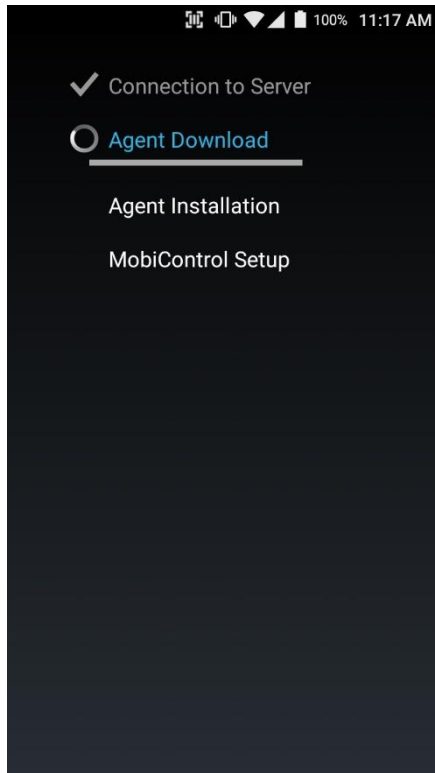

After login, Mobi Control app communicate with SOTI server and then install the Mobi Control agent

**Note:** Agent version determine from SOTI console's setting. If agent version is incorrect after enrollment, please contact to SOTI



# EmKit Remote

## EmKit

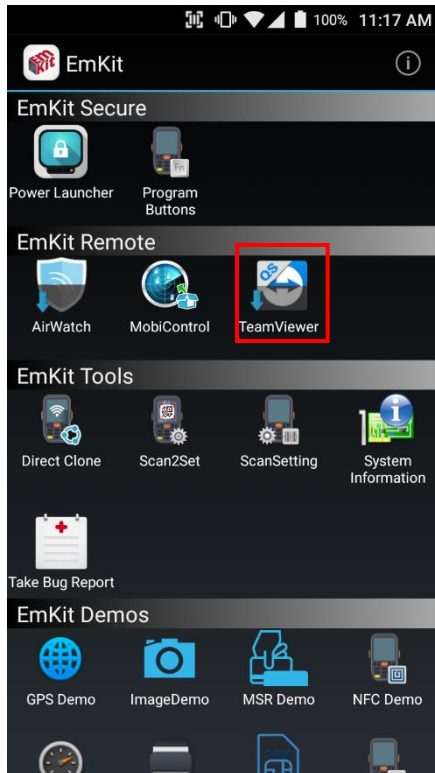

To install the TeamViewer QS app to Point Mobile Android device, please touch TeamViewer icon

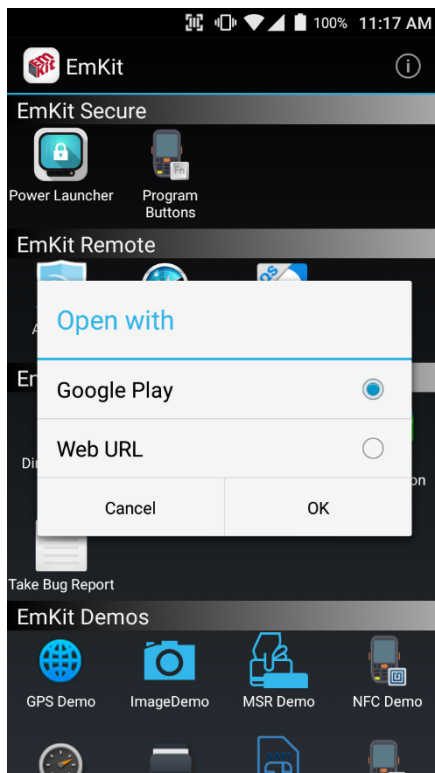

App provides TeamViewer QS app install via Google Play or Web URL.

- Google Play method requires Google account login. TeamViewer QS app download and install managed by Google Play
- Web URL method requires user's manual installation

## EmKit Remote

## EmKit

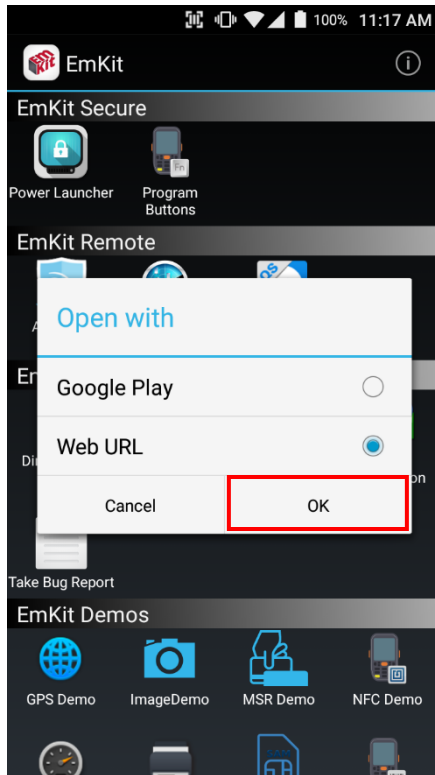

To install TeamViewer QS app from Web URL method, select Web URL and then **OK**

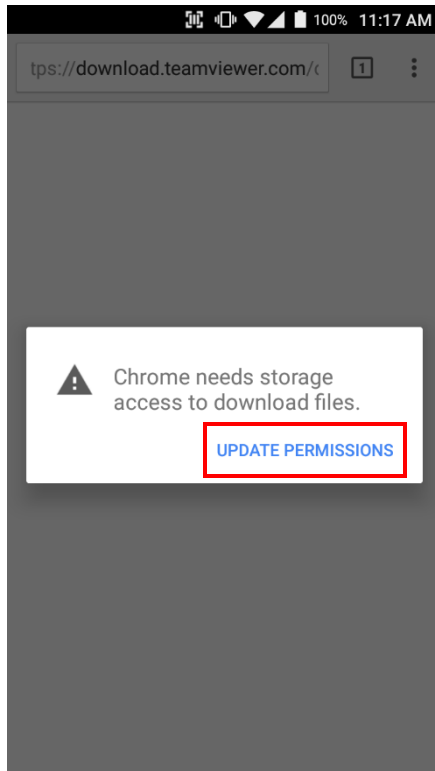

Web browser will download the apk file to the Point Mobile Android device. Before downloading, browser need permission to download apk file to the storage. Please touch **Update Permissions** button

## EmKit Remote

## EmKit

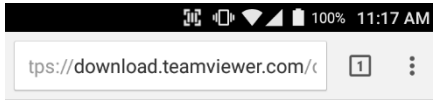

After permission update, web browser download the latest version of TeamViewer QS apk file. Install this apk file to Point Mobile Android device.

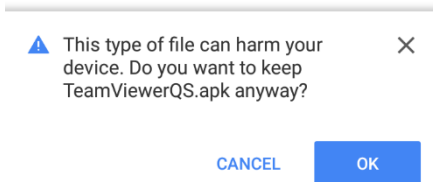

**Note:** If you need to install specific TeamViewer QS version, please contact to TeamViewer

# EmKit Tools

## EmKit

### Direct Clone

Create the **Master PDA** - backup your system settings and apps into a secured file. Without any network connection, Master PDA become a local server in your work place. Nearby Point Mobile device will automatically communicate with Master PDA and download the backup file and then **Restore**.

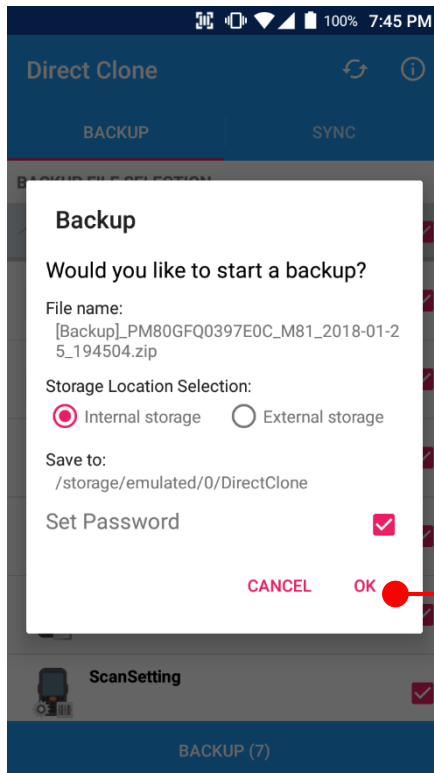

Create the backup file

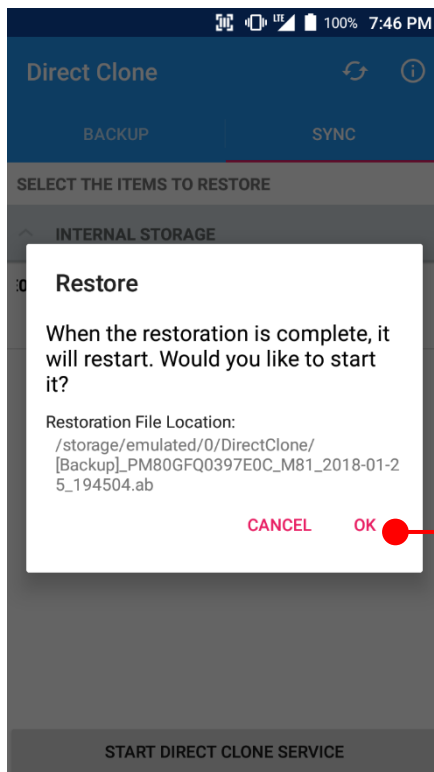

Backed up file will restore your Point Mobile Android device.

# EmKit Tools

## EmKit

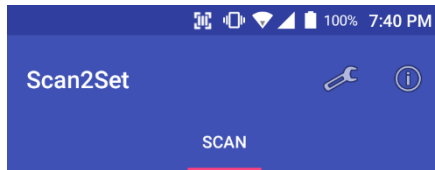

SCAN START

### Scan2Set

Scan2Set is designed for the network environment. Point Mobile Android device downloads the Direct Clone file from the FTP, Web server and Google Drive with just one QRcode Scan!

- Scan your QR code and,
- Connect to your network
  - Restore your PDA
  - Work Managed Device setup

### Step 1. Create Direct Clone Backup file

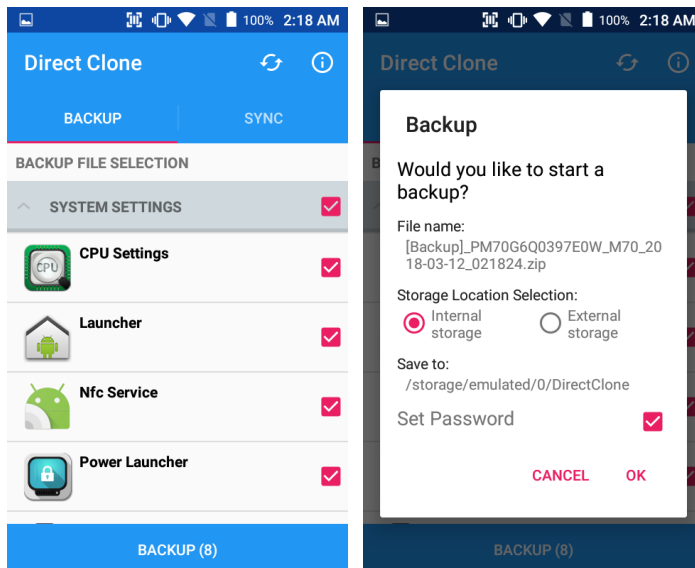

- Make a Direct Clone file from Master PDA device

# EmKit Tools

## EmKit

### Step 2. Upload Direct Clone file to your FTP site or Web server

- Copy the Direct Clone file from the Point Mobile Android device

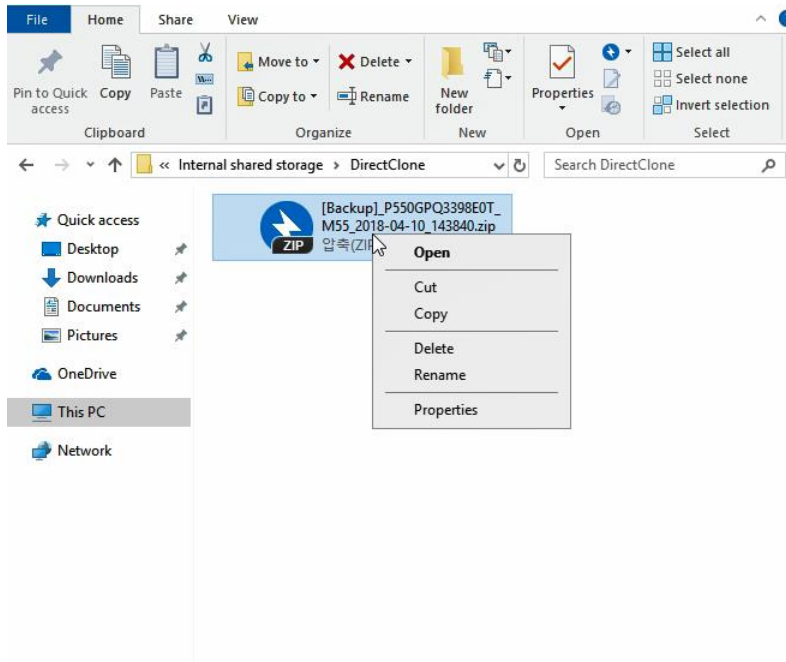

- Upload this file to your FTP site or Web Server. You may change file name

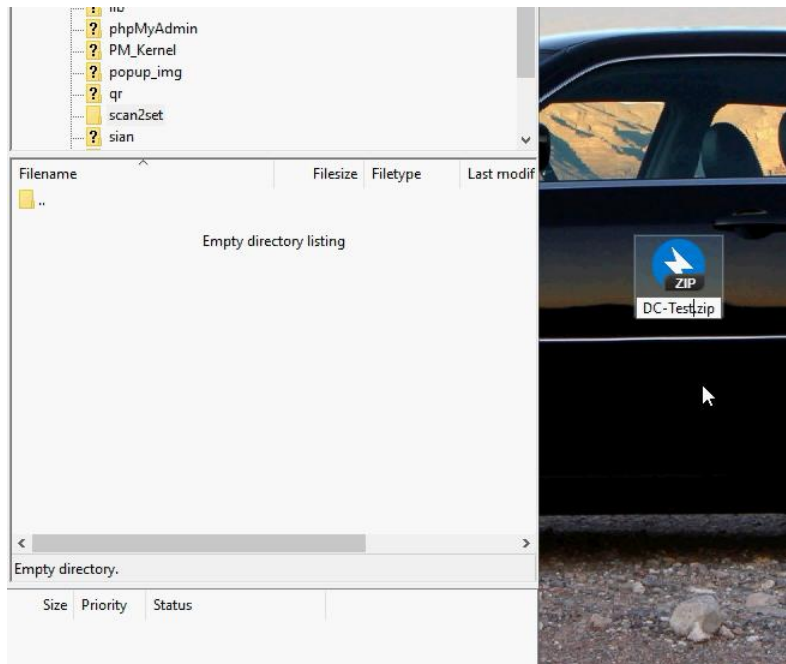

# EmKit Tools

## EmKit

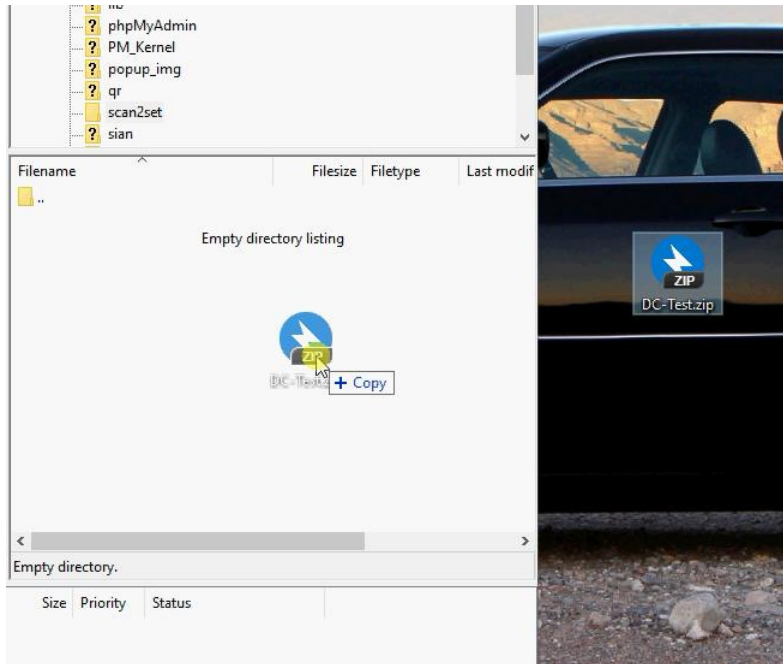

- After file uploading, please check the url first. File should be download with url address.

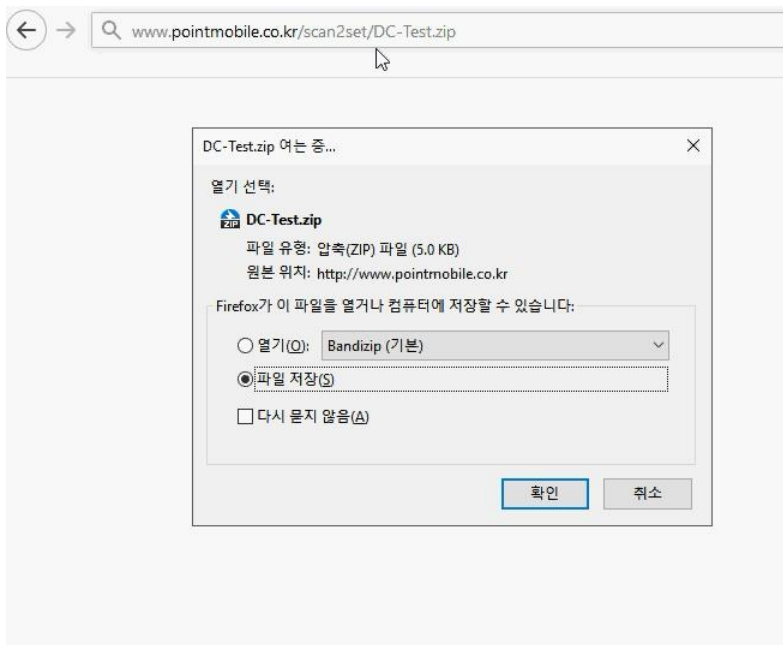

# EmKit Tools

## EmKit

### Step 3. Generate QRcode

- Access to Web QRcode generating site [www.pointmobile.co.kr/qr](http://www.pointmobile.co.kr/qr)

- Click **Web/Google Drive** menu
- Input Network information, Direct Clone file name and password



# EmKit Tools

## EmKit

Web/Google Drive  
FTP  
Work Managed Device Enrollment  
json format

Network Setup

SSID:   
 Hidden

Password:

Security Type:  None  WEP  WPA,WPA2,WPA2PSK

Direct Clone File Location

URL:

File Name:

Password:

**Note:** Make sure put http:// or https:// in front of url address

- Click **Generate QRcode** button and save or print generated QRcode

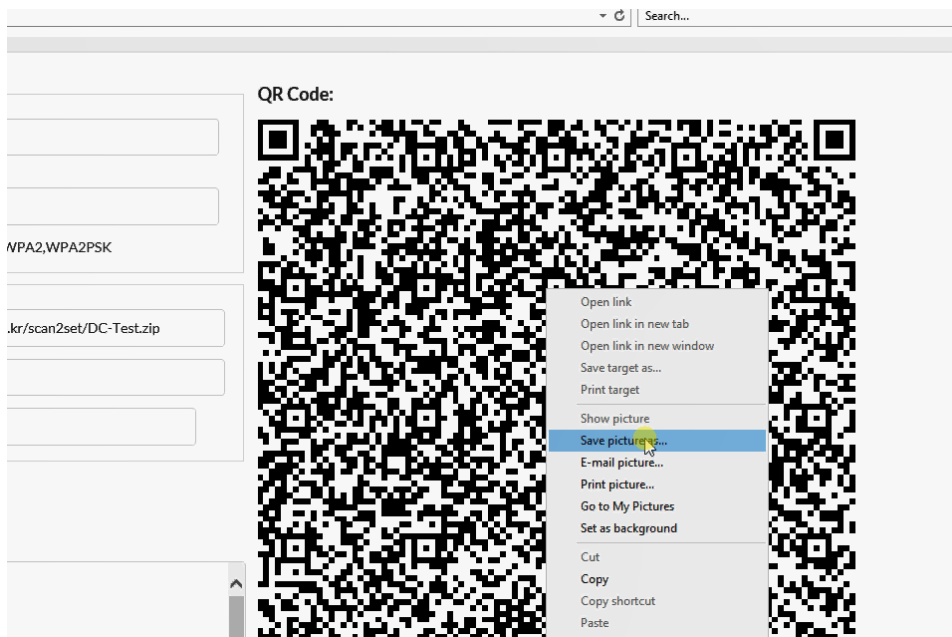

# EmKit Tools

## EmKit

### Step 4. Read QRcode in other PDAs

- Turn on your Point Mobile Android device.
- Press the Power Button, then you will see the Scan2Set in the menu

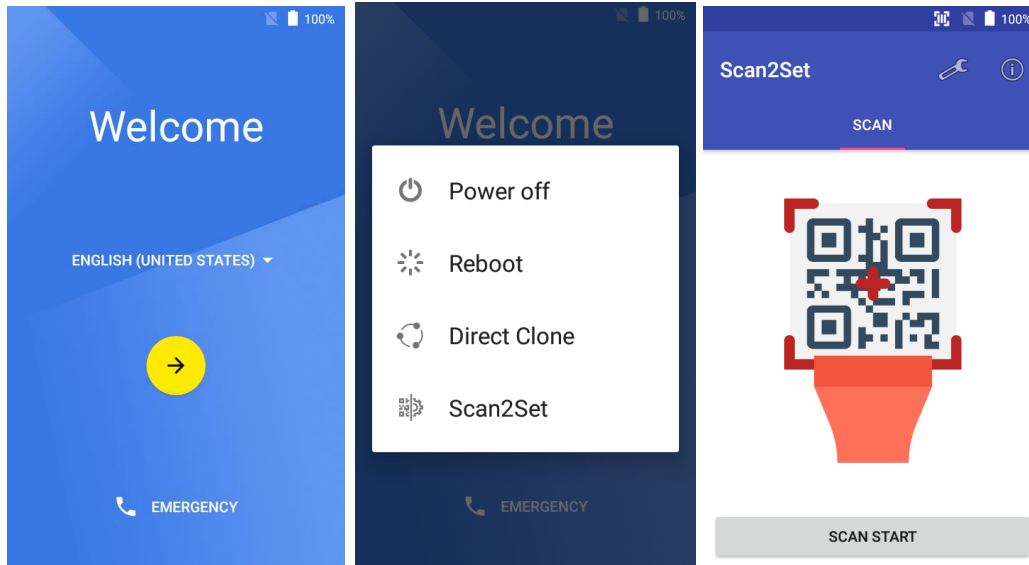

- Read the generated QRcode. Point Mobile Android device will download the file from the FTP site or Web server and restore Direct Clone file

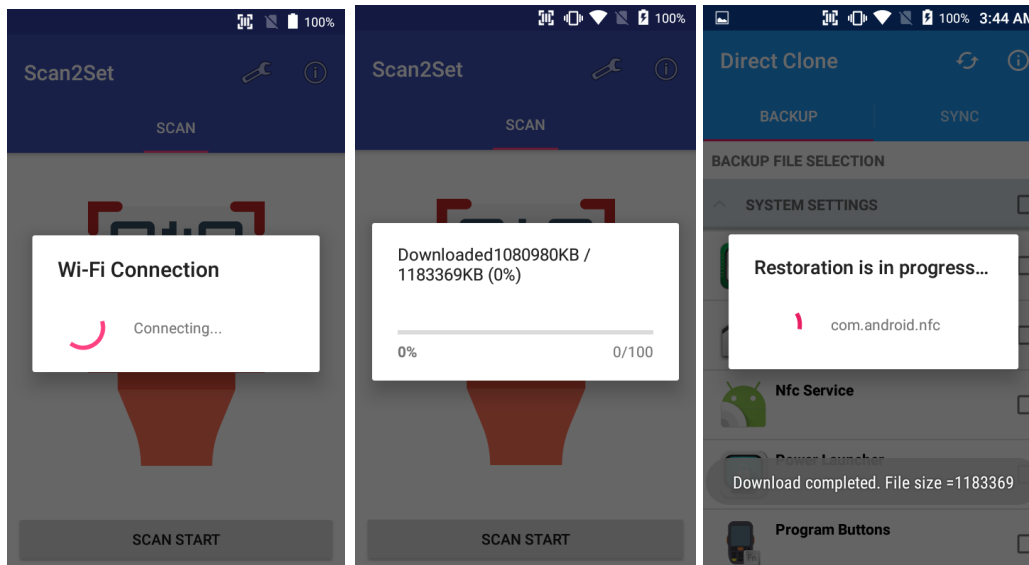

# EmKit Tools

## EmKit

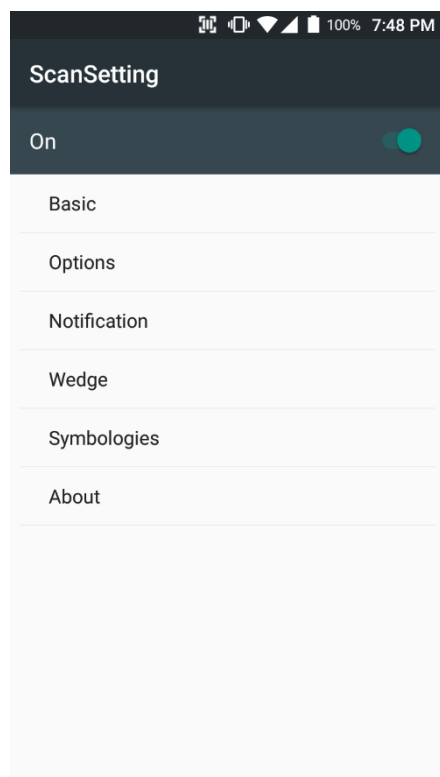

### ScanSetting

You can set your PM80's scanner option with intuitive menu.



### System information

All of SW and HW information available here and can save it to the file.

- Touch **Save to file**.
- **devinfo.html** file saved to root folder of the internal storage.

# EmKit Tools

## EmKit

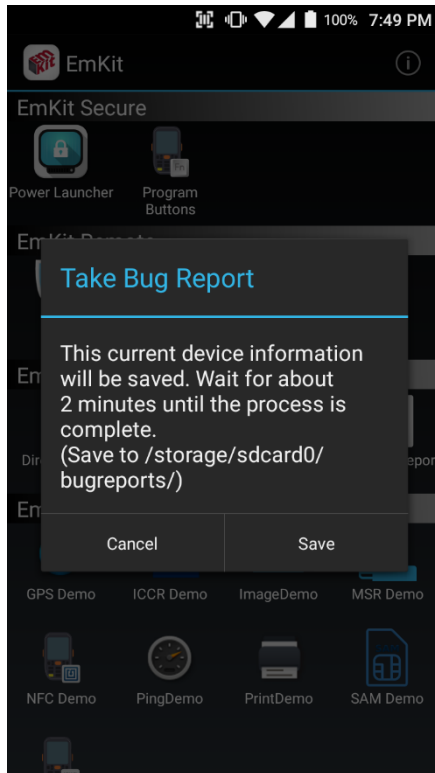

### Take Bug Report

This function save logs and event to the internal storage. When you have a field issue, and need to contact service center, please find the reproduce step first.

- Reproduce the issue.
- After issue, reproduce, please run **Take bug report**.
- File will be saved to **bugreports** folder.
- Copy the file to the PC and then zip it to reduce the file size.
- Share bug report file to the service center or Point Mobile Support team with reproduce steps.

# EmKit Demos

## EmKit

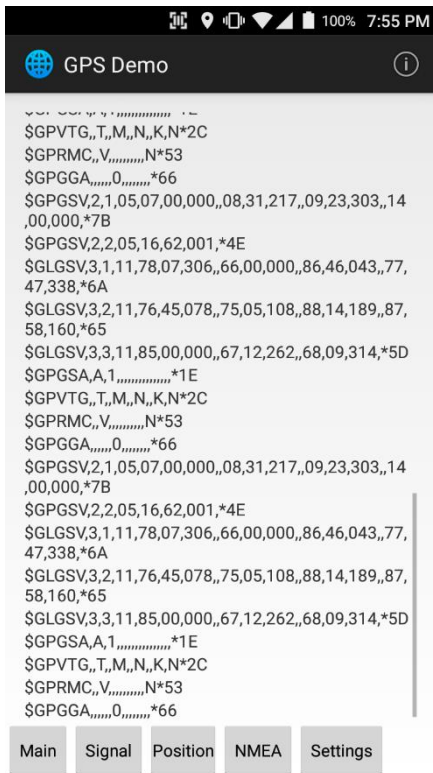

### GPS Demo

Developer can demonstrate or check Point Mobile Android model's GPS signal strength, Satellite info, NMEA info.

*Some of demo app only available for specific Hardware feature integrated SKU (Stock Keeping Unit)*

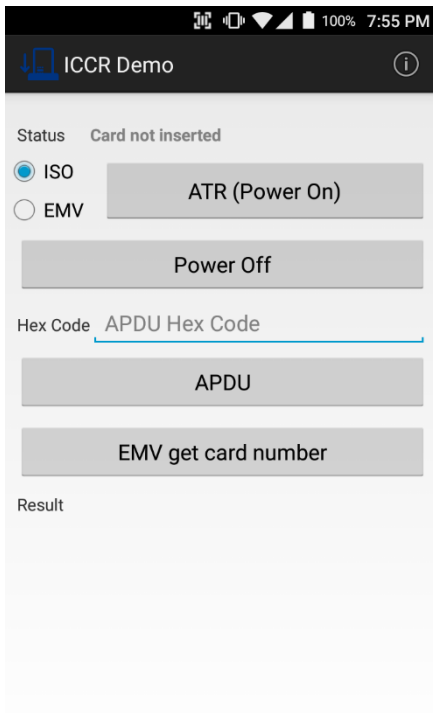

### ICCR Demo

Developer can demonstrate or check Point Mobile Android model's payment solution.

*Some of demo app only available for specific Hardware feature integrated SKU (Stock Keeping Unit)*

# EmKit Demos

## EmKit

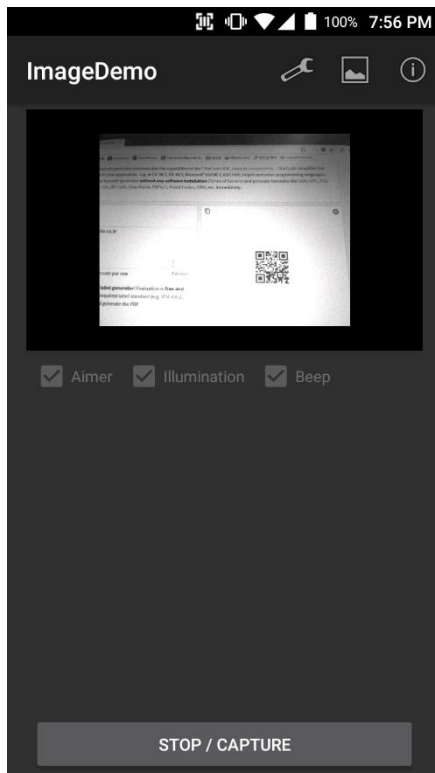

### Image Demo

Developer can demonstrate or check Point Mobile Android model's 2D scanner's image taking solution.

*Some of demo app only available for specific Hardware feature integrated SKU (Stock Keeping Unit)*

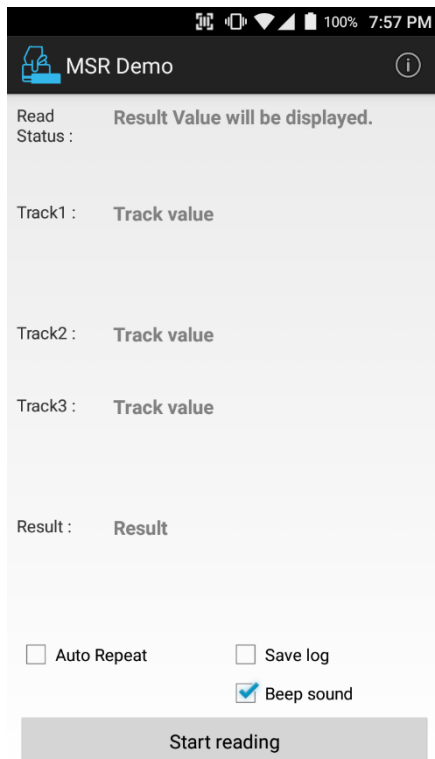

### MSR Demo

Developer can demonstrate or check Point Mobile Android model's IC card and Magnetic card reading solution.

*Some of demo app only available for specific Hardware feature integrated SKU (Stock Keeping Unit)*

# EmKit Demos

## EmKit

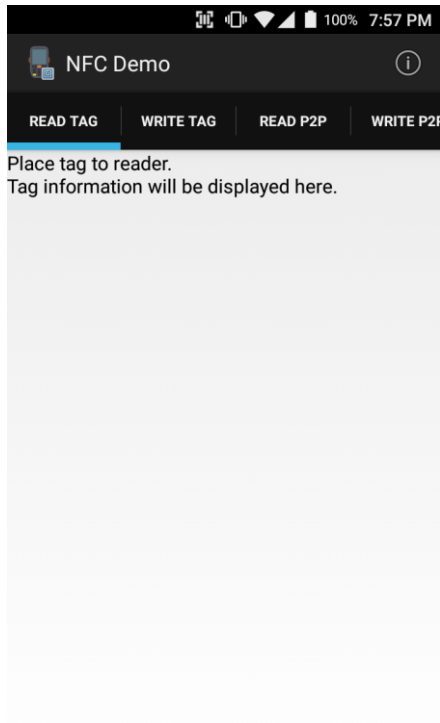

### NFC Demo

Developer can demonstrate or check Point Mobile Android model's NFC Read/Write solution.

*Some of demo app only available for specific Hardware feature integrated SKU (Stock Keeping Unit)*

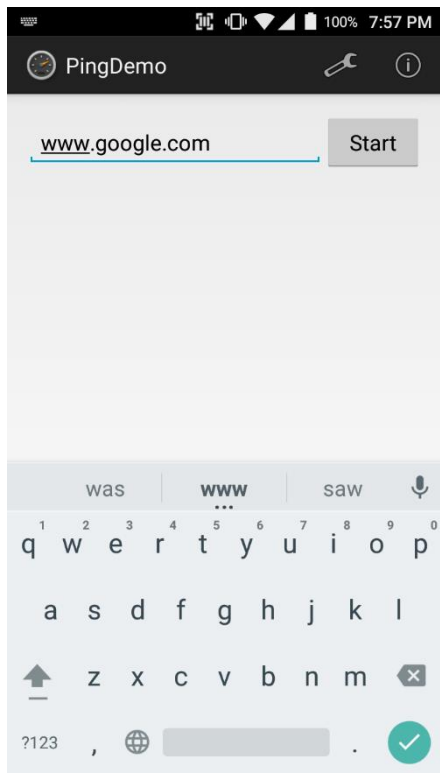

### Ping Demo

Developer can demonstrate or check Point Mobile Android model's ping test.

# EmKit Demos

## EmKit

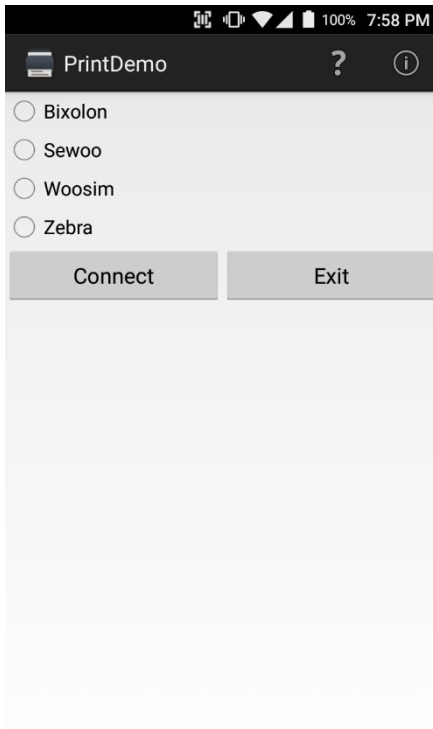

### Print Demo

Developer can demonstrate or check Point Mobile Android model's Bluetooth mobile printing solution.

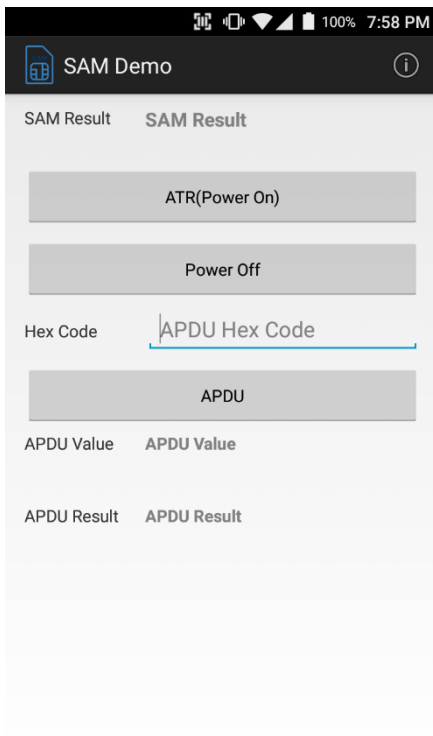

### SAM Demo

Developer can demonstrate or check Point Mobile Android model's SAM communication.

*Some of demo app only available for specific Hardware feature integrated SKU (Stock Keeping Unit)*



# EmKit Demos

## EmKit

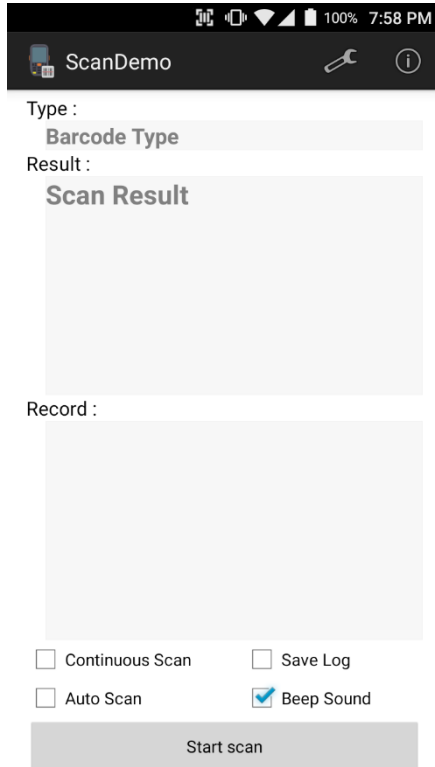

### Scan Demo

Developer can demonstrate or check Point Mobile Android model's Scanner solution.

*Some of demo app only available for specific Hardware feature integrated SKU (Stock Keeping Unit)*



## **POINT MOBILE. CO., LTD.**

### **Offline**

Tel: +82-2-3397-7870~1

ARS: 1800-3010

Fax: +82-2-3397-7872

Address: B-9F Kabul Great Valley, 32, Digital-ro 9-gil,  
Geumcheon-gu, Seoul, Korea 08512

### **Online**

Website: <http://www.pointmobile.co.kr/>

E-mail: [pm\\_support@pointmobile.co.kr](mailto:pm_support@pointmobile.co.kr)