



For Android™ 6.0.1

Enterprise Mobility

PM80

User Manual

User Manual

Please note your phone is battery-embedded design with removable battery and battery cover. Unauthorized personnel are strictly prohibited from disassembling the phone. Make sure to use only the power adapter (5V 2A Output AC/DC) that came with PM80.

In case your phone does not work as expected, you are strongly recommended to restart it by pressing and holding the power button for at least 12 seconds until the startup screen appears. If your phone has encountered a serious error and cannot be recovered, you should reset your phone to factory settings by using the menu, either “Backup & Reset”, or “Factory Reset”. For more details, please refer to “Factory data reset” section on page 44

Note: Please be cautious while performing the factory data reset. Because this will erase personalized settings and data saved in your phone, such as SMS, Contacts, Music, etc.



www.sar-tick.com

Body-worn Operation

This device was tested for typical body-worn operations with the front & back of the phone kept 0.2 inches (0.5 cm) between the user's body and the front & back of the phone. A minimum separation distance of 0.2 inches (0.5 cm) must be maintained between the user's body and the front & back of the phone. Any belt clips, holsters, and similar accessories containing metallic components may not be used. Body-worn accessories that cannot maintain 0.2 inches (0.5 cm) separation distance between the user's body and the front & back of the phone, and have not been tested for typical body-worn operations should be avoided.



PROTECT YOUR HEARING

To prevent possible hearing damage, do not listen at high volume levels for long periods. Exercise caution when holding your device near your ear while the loudspeaker is in use.

Rev 03

Table of Contents

User Manual.....	1
Table of Contents.....	2
Getting Started.....	3
Major Parts	3
Accessory	5
Setup PM80.....	6
Charge PM80.....	9
Turn On/Off PM80.....	10
Hot swap the battery	11
Learning the basics.....	12
Use a keypad	12
Use a touch screen	14
Home Screen, Apps and Widget.....	16
Status & Notifications Icons	20
Make a call	22
Add to a contact.....	24
Send a message.....	25
Connect to your Wi-Fi network.....	27
Scanner Settings	29
Use a Scanner	29
Scan a Barcode	36
Read a Credit Card.....	38
OS Update.....	40
OS Image update from a Storage.....	40
OS Image update from the FOTA.....	42
Factory data reset	44
Factory data reset from Settings.....	44
Force Factory data reset	46
EmKit.....	49
EmKit Secure	50
EmKit Remote.....	53
EmKit Tools.....	61
EmKit Demos	70

Major Parts

Getting Started



1. Barcode Scanner



2. LED Indicator
3. Illuminance / Proximity Sensor
4. Front Camera

5. Touch Screen

6. Front Panel

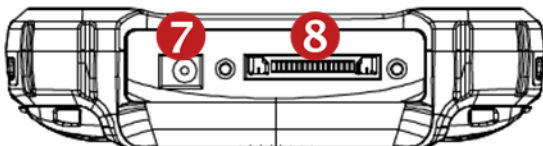

7. AC / DC Adaptor Jack

8. Direct Sync I/O Connector

Major Parts

Getting Started

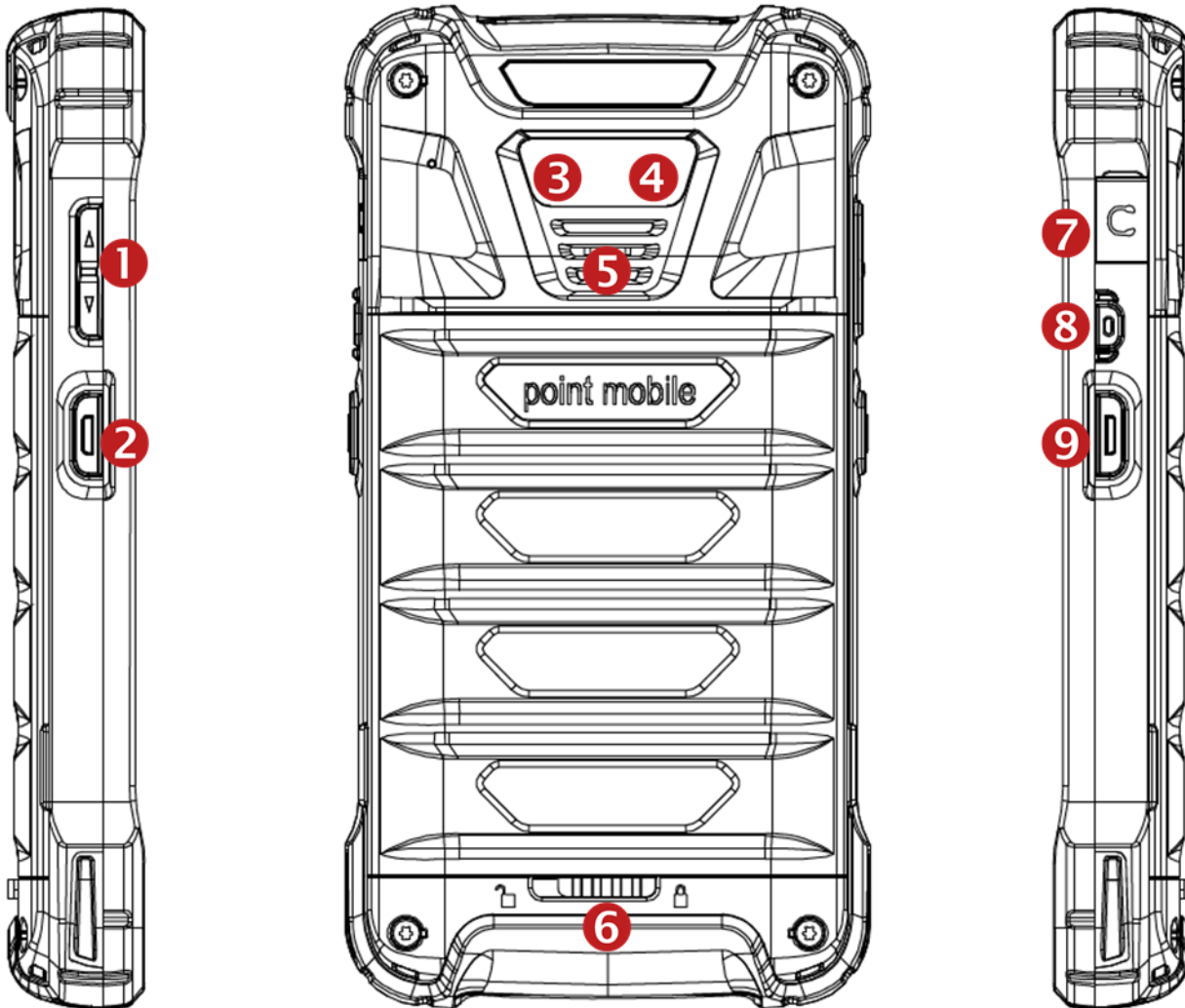

1. Volume Key
2. Scanner Trigger
3. Camera
4. Flash Light
5. Speaker
6. Battery Cover Lock
7. 3.5mm Audio Jack
8. Power Key
9. Scan Trigger Key

Accessory

AC/DC adapter



LCD protection film



Getting Started

Plug (US/ EU/ UK)





Li-ion battery
(3,000mAh or 4000mAh)



Setup PM80

Getting Started

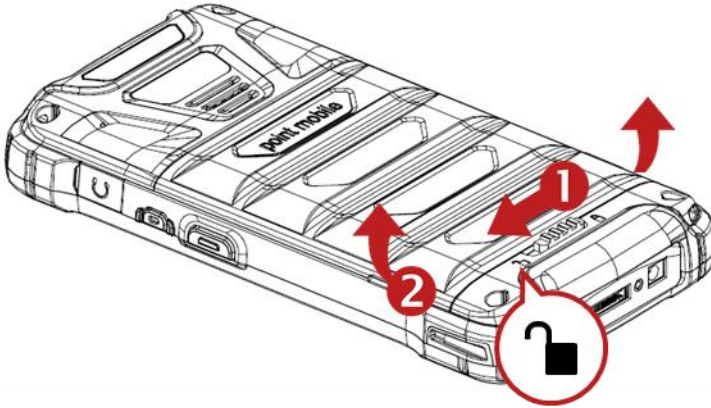
Remove the Battery Cover

1. Slide “Battery Cover Lock” to the “Unlock 

Insert SIM card and SAM card

1. Insert the SIM card and SAM card (Optional) into the each slot. (Gold contact should face down)
2. To remove the card, gently slide it out of the slot.

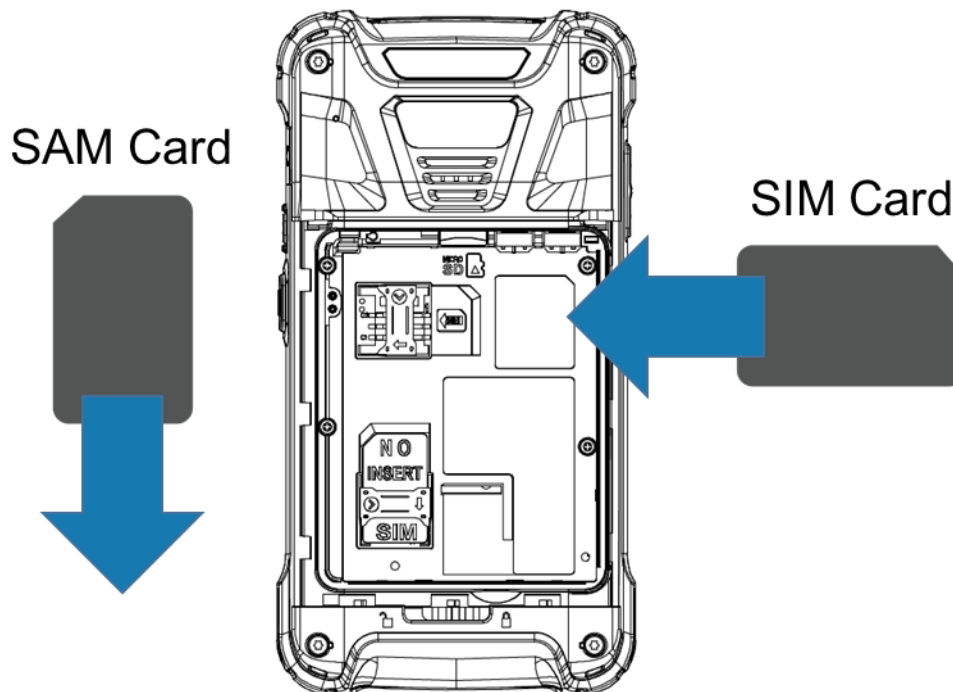

Setup PM80

Getting Started

Note: Your device only supports SIM cards. Do not attempt to insert other SIM types such as “Micro” and “Nano” SIM card, this may cause damage to your device. If you have to use different SIM card types, please use “SIM adaptor”.

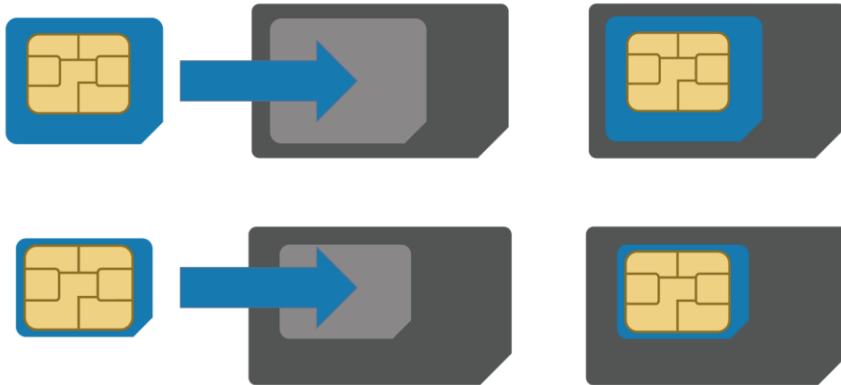

Install and Remove the microSD card

1. Insert the microSD card into the slot (Gold contact should face down).
2. To remove the microSD card, gently slide it out of the slot.

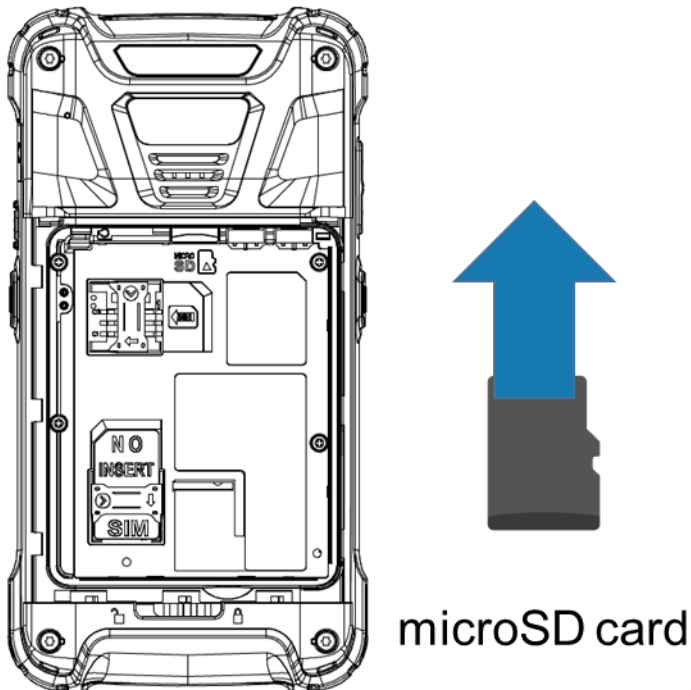

Note: To avoid data loss and SD card damage, please ensure the SD card is unmounted from Android system “**Settings – Storage - Unmount SD card**”

Setup PM80

Getting Started

Insert the Battery

Insert "Battery" from top area first and then put in bottom area. Make sure battery contact "Battery Pin" is correctly inserted.

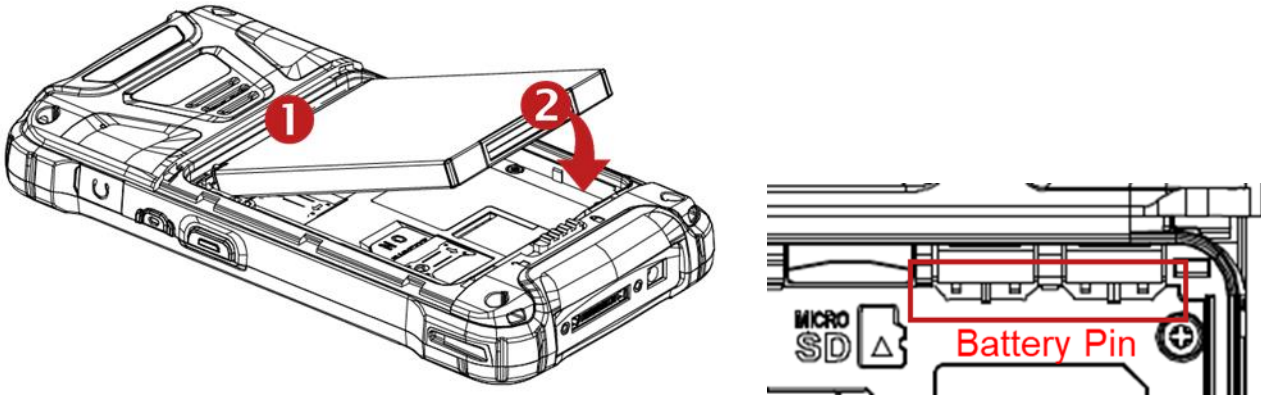

Close the Battery Cover

Insert "Battery Cover" from the top area first and then put in bottom area. Press battery cover with both hand and Make sure "Battery Cover Lock" is "Locked" (🔒).

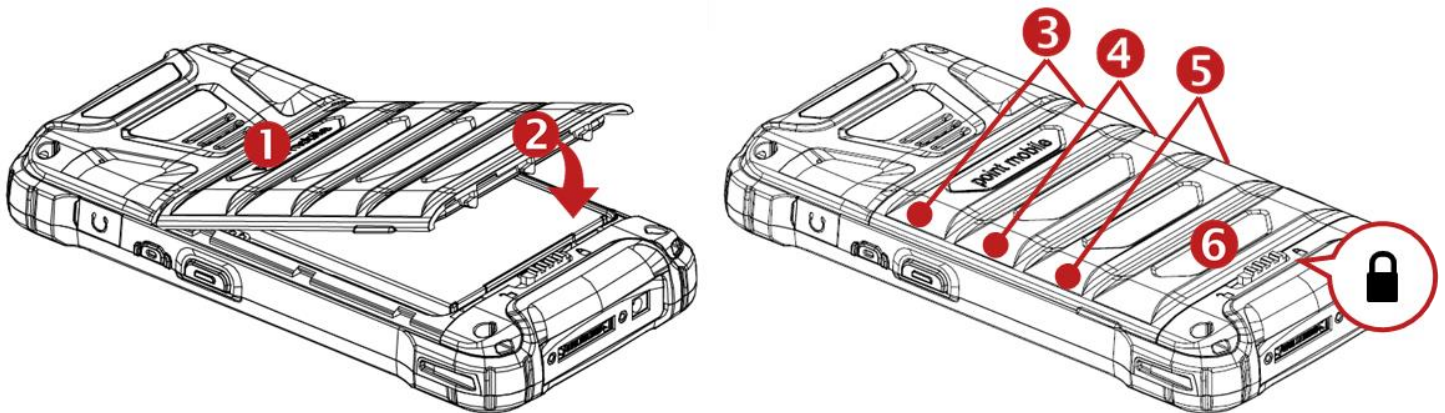

Charge PM80

Getting Started

1. Connect the AC/DC adaptor to your device and wall socket respectively

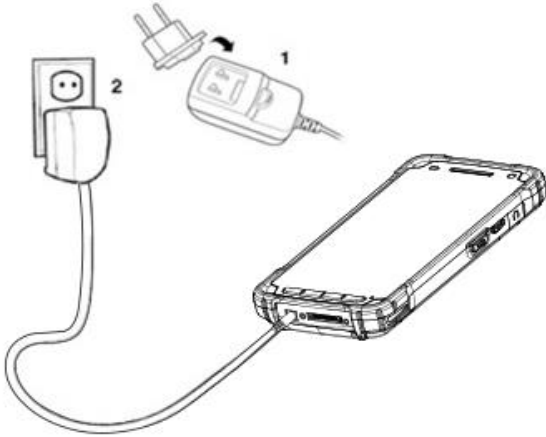

2. LED indicator will display charging status.

Steady Red	Battery is charging or Battery level is low
Blinking Red	Battery level is critical low
Steady Green	Battery is fully charged
Blinking Red and Green	Battery is removed or fail to recognize

PM80 Battery Specification

Standard Battery	3.8V, 3,000mAh
Extend Battery	3.8V, 4,000mAh
Backup Battery	4.2V, 60mAh
Charging time	Standard Battery : About 4hours
from Low battery level	Extend Battery : About 6hours

Note: Always use an original charger and cable from the Point Mobile. Other chargers and cables may damage PM80. In addition, make sure connector, charger, cables are not wet.

Turn On/Off PM80

Getting Started

Turn On

1. Press and hold down the “Power Key” for a few seconds.
2. When PM80 enter to the boot mode, it will display “SMART BEYOND RUGGED” logo with short vibration
3. Release the “Power Key” and wait until PM80 finish booting

Note: If you cannot turn on your PM80, try below steps

- To turn on PM80, battery needs to be charged certain level. Please charge first
- Press and hold the “Power key” for 12 seconds to force reboot
- Press and release the “Reset Hole” and then turn on PM80 again

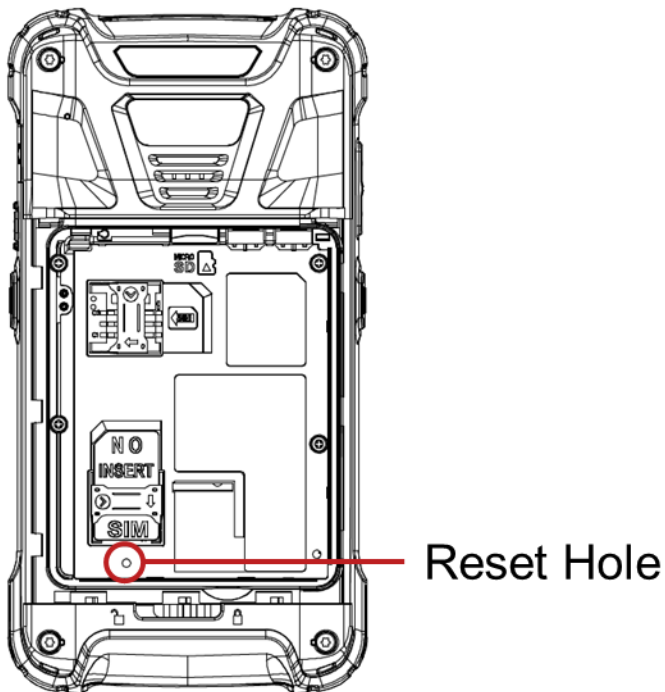

Turn Off

1. Press and hold the “Power Key” until you see the power menu
2. Among the menu, tap “Power Off”

Hot swap the battery

Getting Started

When battery level is low, you can replace the battery without turning off and on PM80.

- Remove the Battery and replace to another one.

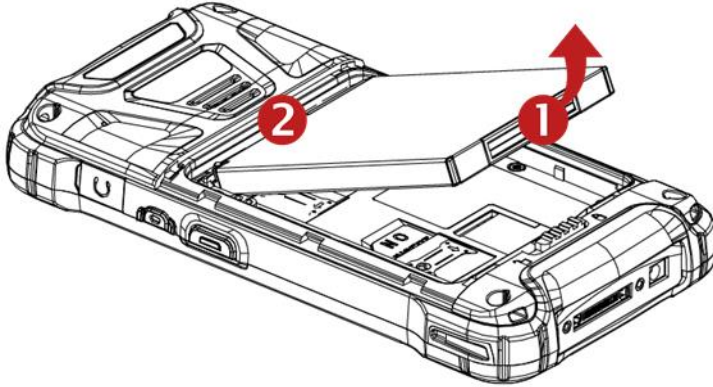

- Make sure the battery cover closed firmly.

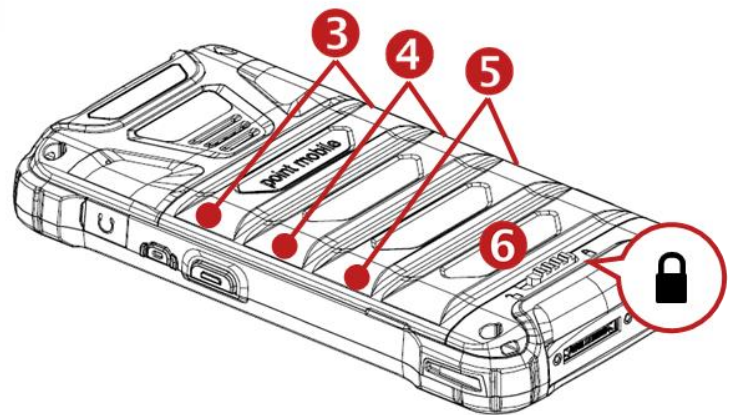
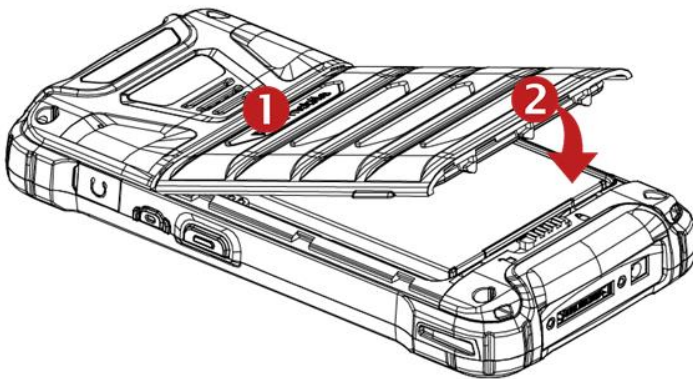

- Press the Power Key to use PM80 again.

Use a keypad

Learning the basics

Power key

Press

- Lock the screen / Light up the screen.



Press and hold

- Display the power menu “Power Off / Reboot / Airplane mode”

Press and hold for 12seconds

- Forced to reboot

Press the “Power” key and “Volume Down” key together

- Screen capture

Volume keys

In general

- Adjusts the ringtone volume or “Mute” the ringtone of an incoming call.

In call mode

- Adjusts the earpiece or headset volume.

In Music / Video / Streaming

- Adjusts the media volume.

In camera preview

- Take the photo by pressing Volume Up or Down key.



Scanner Triggers

When “Scan Wedge” mode is activated

- By pressing, PM80 scan the barcode.



Using a keypad

Learning the basics

Front panel

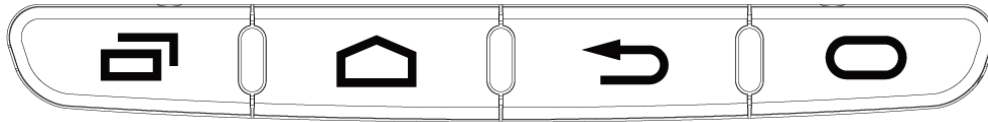

Recent Apps key

- Press to see recently used apps.

Home key

- From any apps or screens, press to return to the Home screen.

Back key

- Press to go back to the previous screen, or to close a dialog box, options menu, notification panel, etc.

Function key (Programmable)

- Press to run the function or the app. You can set **EmKit - Program Buttons**

Use a touch screen

Learning the basics

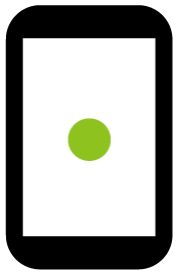

Touch

One-finger press



Double touch

One-finger press, lift, one-finger press, lift for “Zoom in”



Long press

One-finger press, wait, lift for “Select an item”

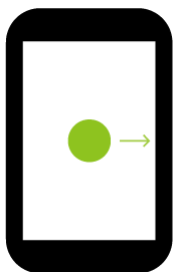

Drag, Swipe, or Fling

One-finger press, move, lift for “Scroll” or “Tilt”

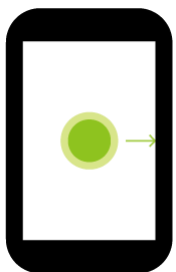

Long-press drag

One-finger press, wait, move, lift for “Pick up and move” or “select multiple items”

Use a touch screen

Learning the basics

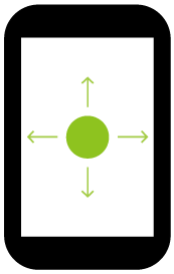

Scroll

Vertical or horizontal swipe in a single direction

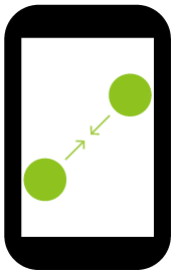
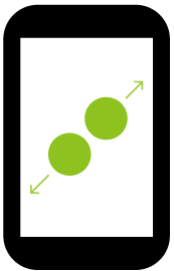

Pinch Open & Close

Two-finger press, move outwards and inwards, lift for “Zoom in and out”



Rotate

When PM80 is turning sideways, screen orientation is changing

Home Screen, Apps and Widget

Learning the basics

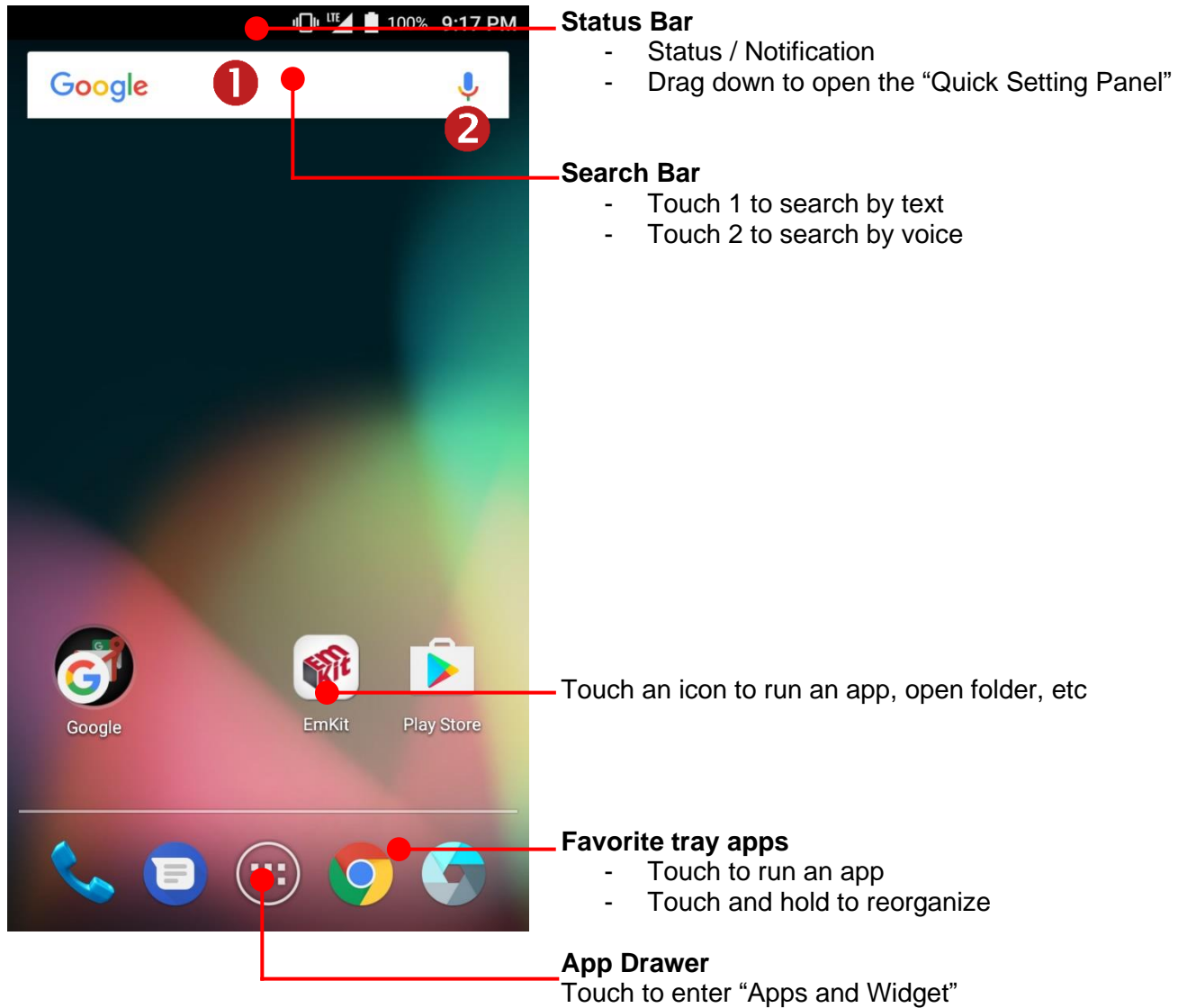

Home Screen, Apps and Widget

Learning the basics

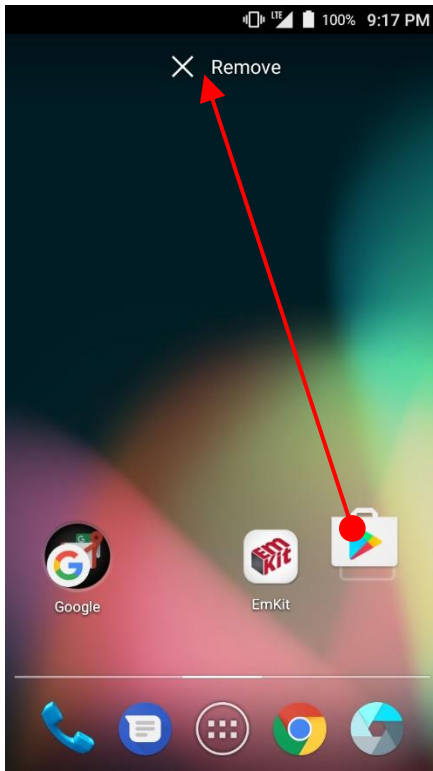

Remove the app icon from home screen

- Long press the app icon and then drag it to the "Remove" area and then release

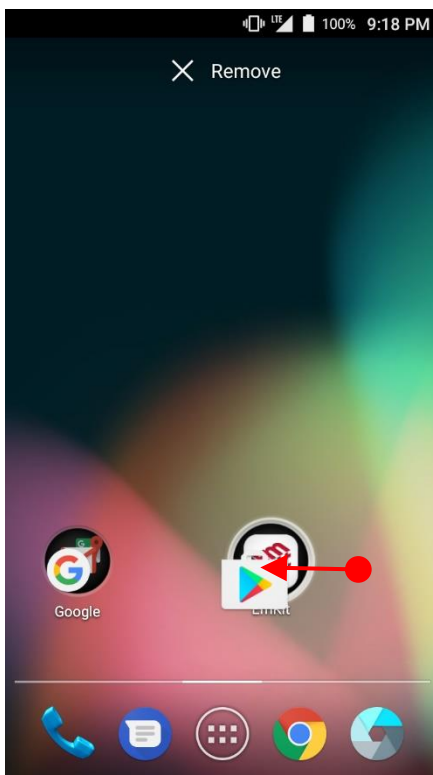

Create "App Folder"

- Long press the app icon to other app icon. This will create the "App Folder"
- To set the folder name, touch the "Unnamed Folder" and rename it

Home Screen, Apps and Widget

Learning the basics

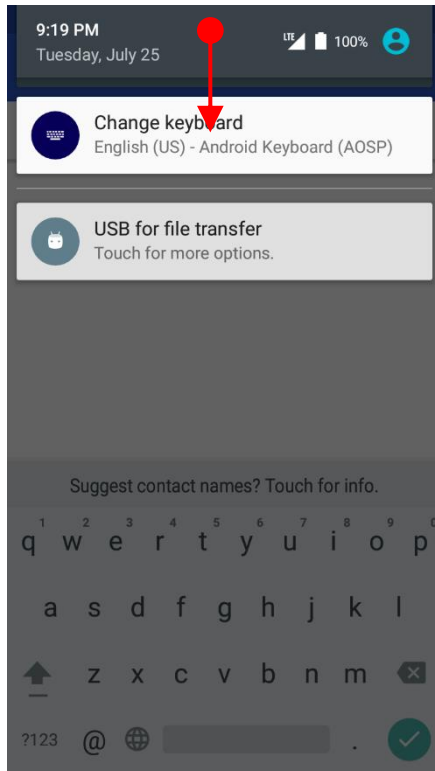

Notification panel

When there are notifications from the Android (system) or the App, you can check details by drag down the “Status Bar”.

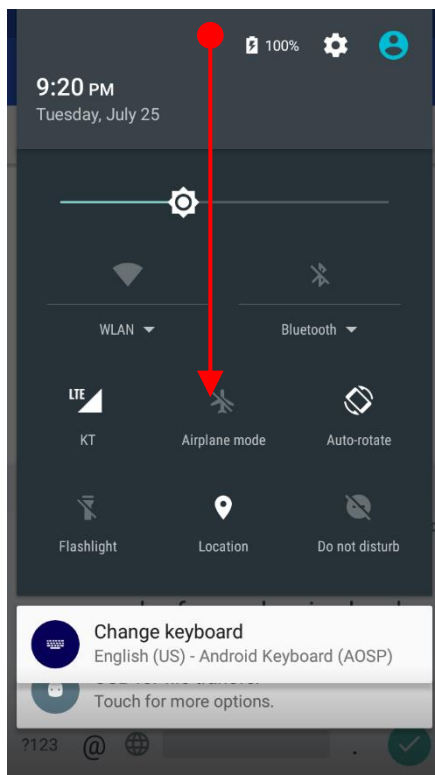



Quick setting panel

You can access “Quick setting panel” by drag down the “Notification panel”. You can enable / disable functions or change modes easily.

Home Screen, Apps and Widget

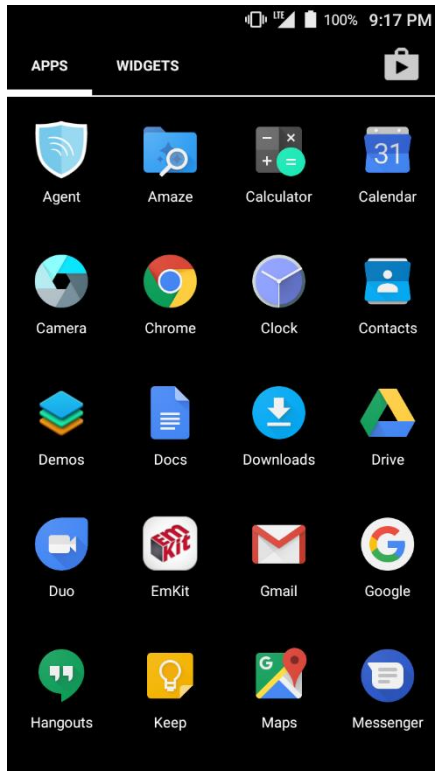
Learning the basics



By touching the “App drawer” icon,  you can enter to the “Apps” and “Widgets”

All installed apps are listed in the “Apps” tab, alphabetically

- Tap app icon to run.
- Long press, specific app icon to place to the “Home Screen”.

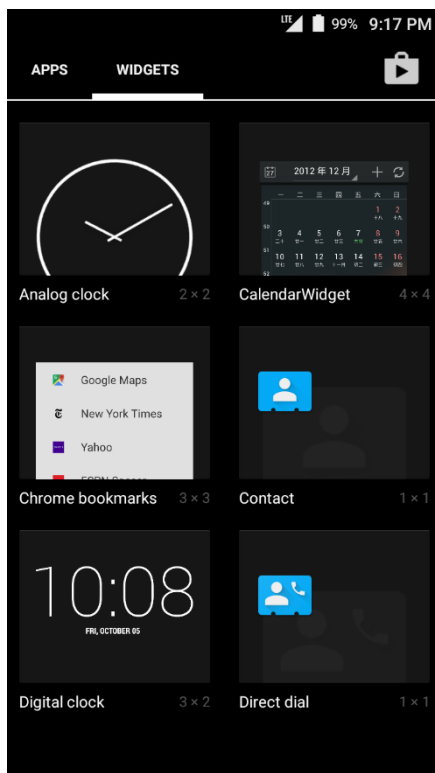





























All available widgets are listed in the “Widgets” tab, alphabetically.

- Long press, specific widget to place to the “Home Screen”.

Status & Notifications Icons

Learning the basics













Status icons

	GPRS connected		GPRS in use
	EDGE connected		EDGE in use
	3G connected		3G in use
	4G connected		4G in use
	Signal strength		No signal
	Roaming		Airplane mode
	No SIM card installed		
	WLAN is on		Connected to a WLAN network
	Bluetooth is on		Connected to a Bluetooth device
	Battery is full		Battery is partially drained
	Battery is low		Battery is very low
	Battery is charging		
	GPS is on		Alarm is set
	Speaker phone is on		Headset connected
	Vibrate mode/ Mute		Phone mic is mute

Status & Notifications Icons

Learning the basics

Notification icons

	Missed call		New SMS or MMS message
	New Email		Connected to VPN network
	Upcoming event		Screenshot captured
	Preparing SD card		SD card removed, unexpectedly
	OTG device connected		
	File uploaded		File downloaded
	There are more notifications		Other input method available

Make a call

Learning the basics

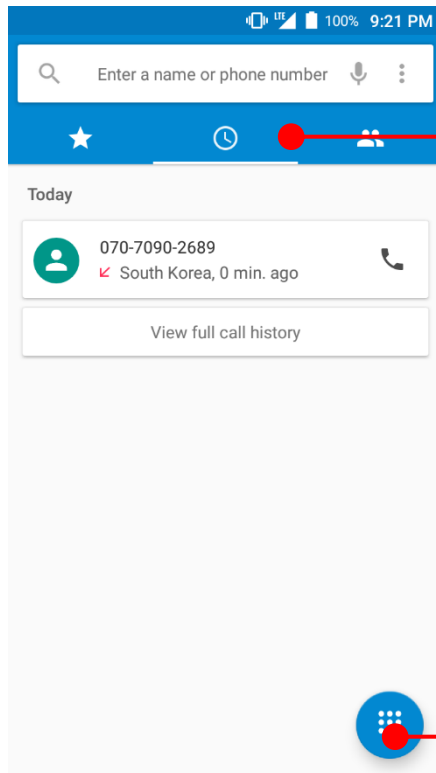

Touch  icon in the Favorite tray apps

Slide to access the “FAVORITE”, “RECENTS” and “CONTACTS”.

- To make a call from recent call list or missed call, select “RECENTS” tab
- To make a call from your contact list, select “CONTACTS”

Touch to use a dialer

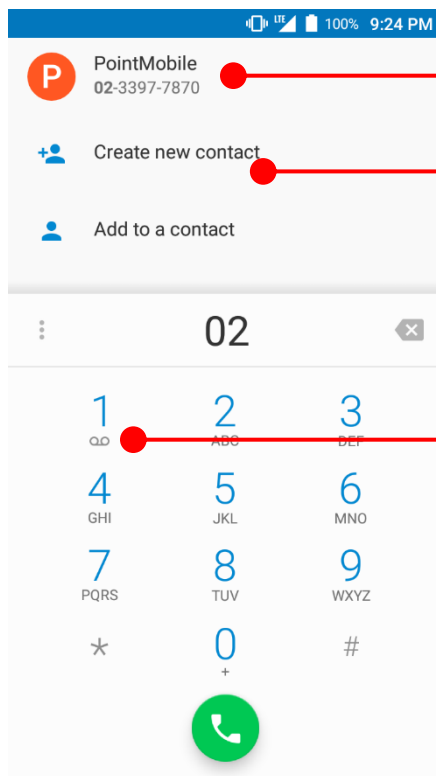

Suggested phone number(s)

Phone number can be saved to “CONTACTS”

Touch and hold the dial pad #1, to access voicemail.

Make a call

Learning the basics

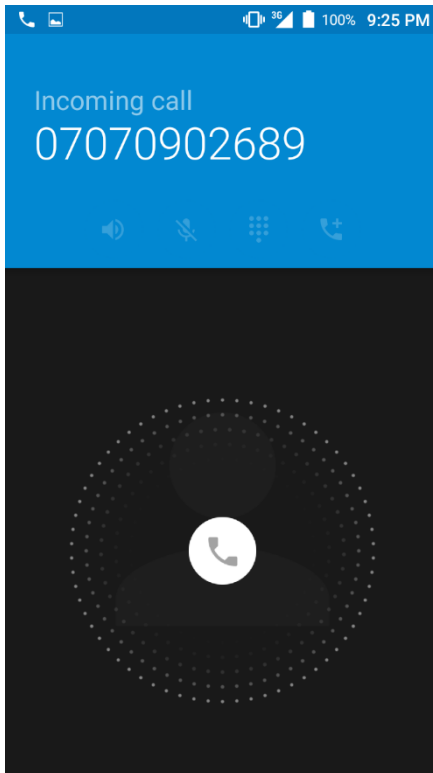

You can answer or rejecting a call by sliding the phone icon

Slide the  icon to the right direction in order to answer the call

Slide the  icon to the left direction in order to reject the call



Slide the  icon upwards to reject the call and send a preset message to the caller.

Tip: To mute the ringtone volume of an incoming call, keep press the “Volume down” key or turn your PM80 over.

Add to a contact

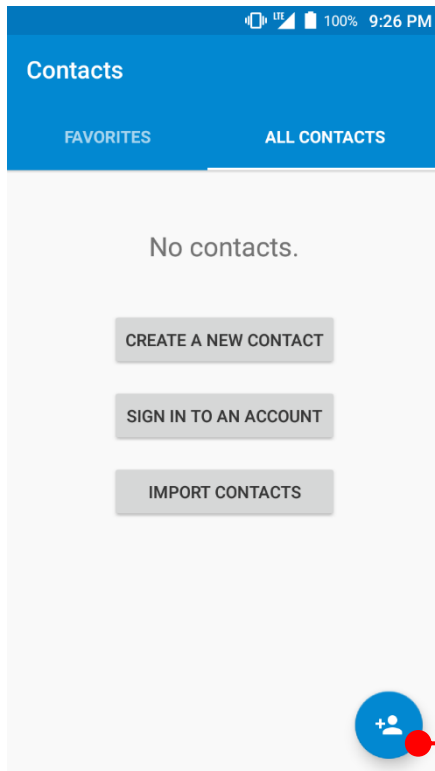
Learning the basics



Touch  "App Drawer" icon and then  icon

CREATE A NEW CONTACT

- You can manually create the new contact

SIGN IN TO AN ACCOUNT

- You can sync with your contacts in the Google account.

IMPORT CONTACTS

- You can import contact in the storage (.vcf file) or SIM card

Touch to add a new contact

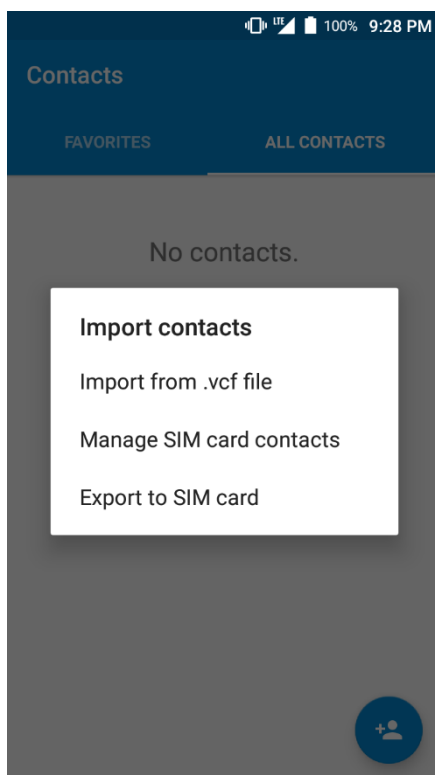

Send a message

Learning the basics

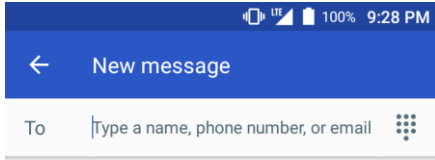

Touch  icon in the Favorite tray apps

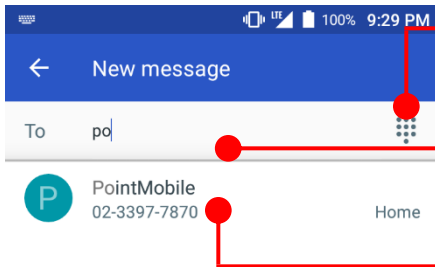

Touch to use a dialer

Touch to type a name, phone number or email

Suggest contact display here. Touch “Contacts” to compose a message

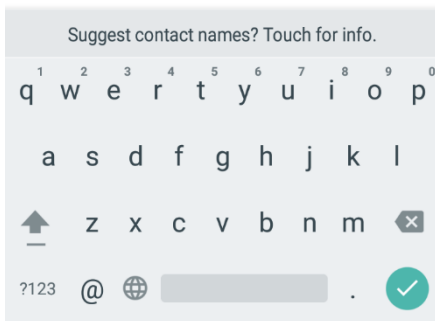

Send a message

Learning the basics

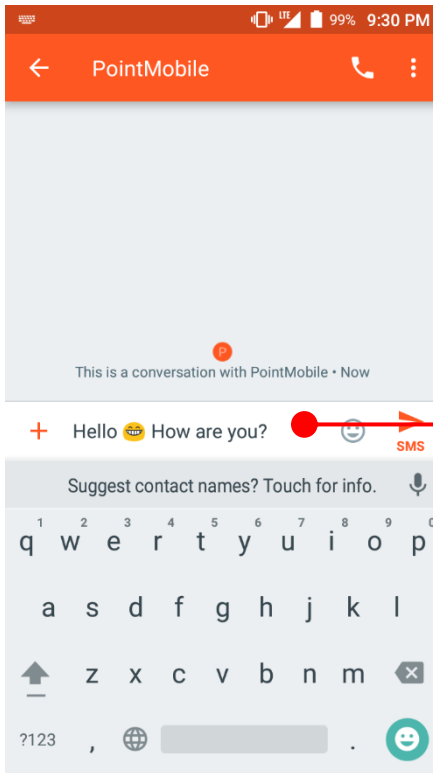

Your message display here

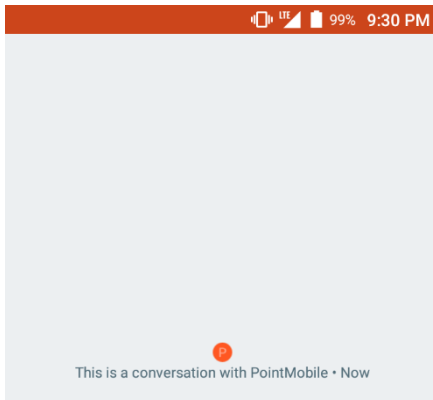

Touch to send the composed message

You can attach photo, saved picture, voice or location



To take a photo, give access to Camera

ALLOW



Note: You may allow granting “Message App” access specific app or service.

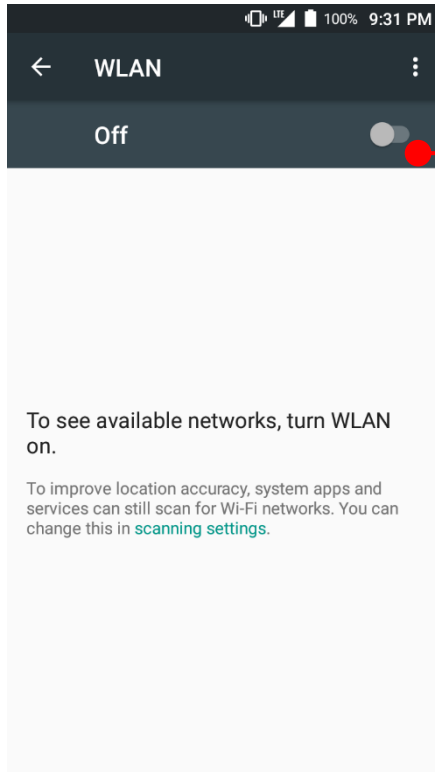

Connect to your Wi-Fi network

Learning the basics



Touch  "App Drawer" -  "Settings" and then "WLAN"
Touch to turn On / Off the W-Fi

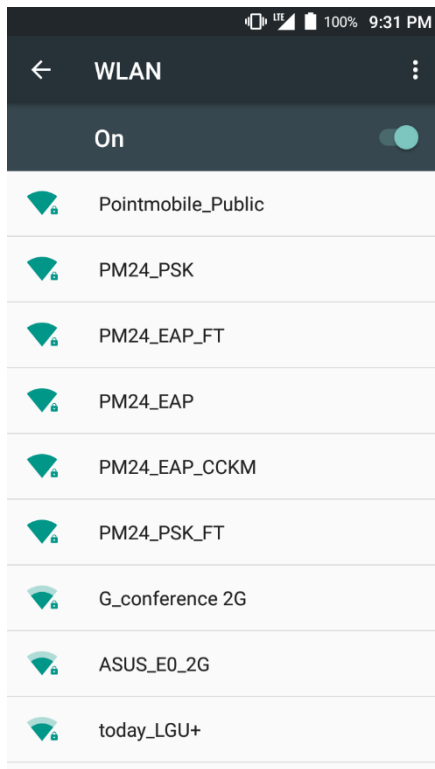

You can see nearby Wi-Fi network. Each AP's SSID information listed by signal strength



Icon means: Open Wi-Fi network. You don't need to enter the password



Icon means: Secured Wi-Fi network. To connect this Wi-Fi, you need to enter the password

Connect to your Wi-Fi network

Learning the basics

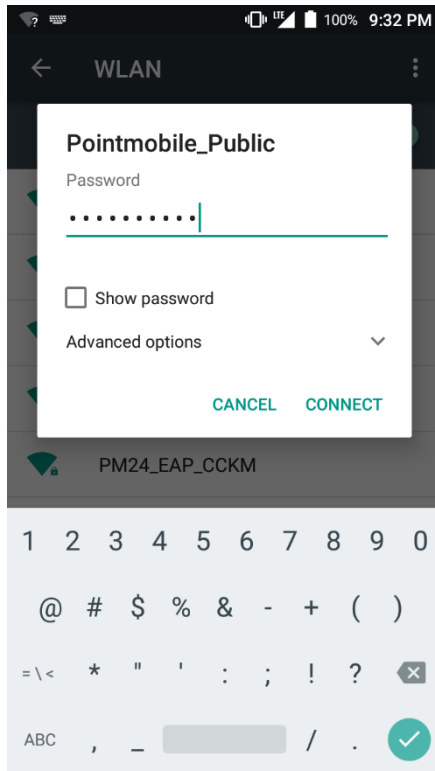

Touch SSID, which you want to connect.
To connect to secured network, enter the password

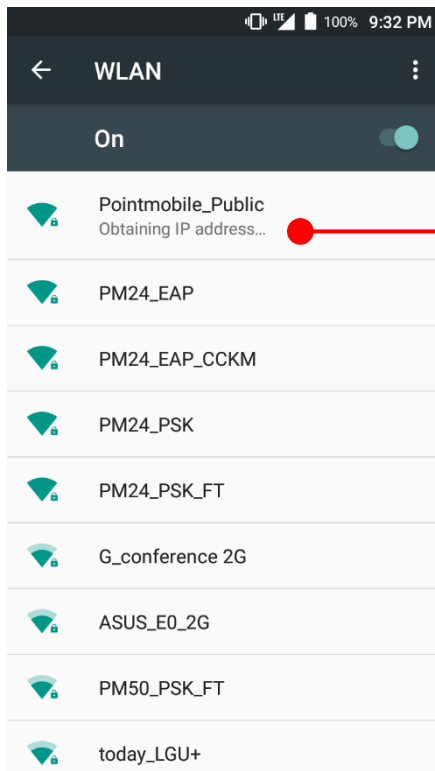



Your PM80 is obtaining the IP address from selected AP

Use a Scanner

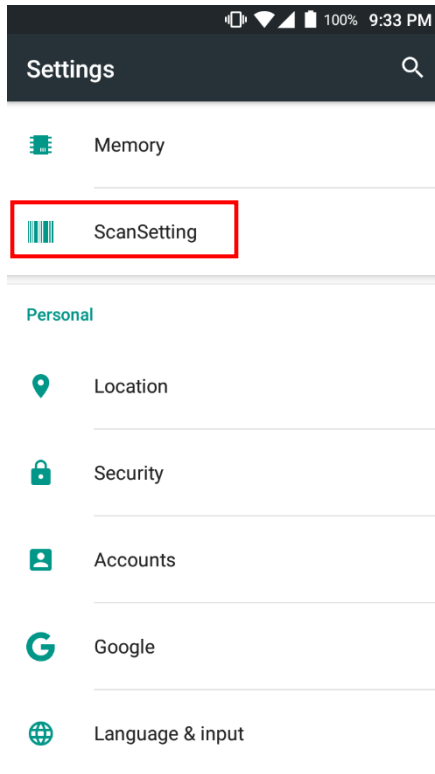
Scanner Settings



Default setting of Scanner is “Off”
To use the Scanner,

- Touch  EmKit and then “ScanSetting”
- Touch  “App Drawer” -  “Settings” and then “ScanSettings”

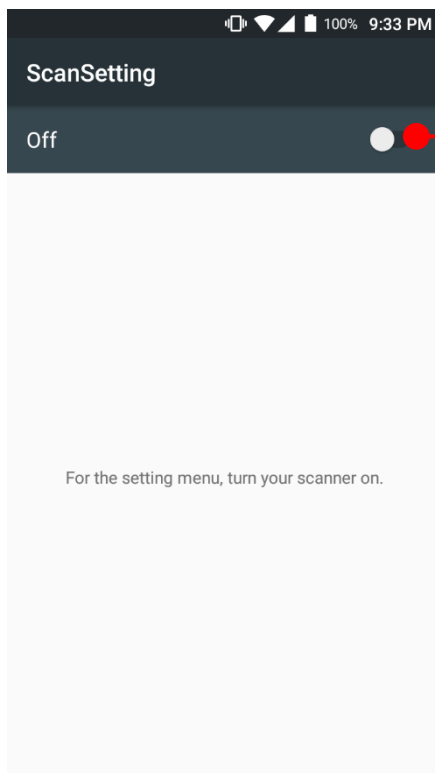

Touch to turn on the Scanner

Use a Scanner

Scanner Settings

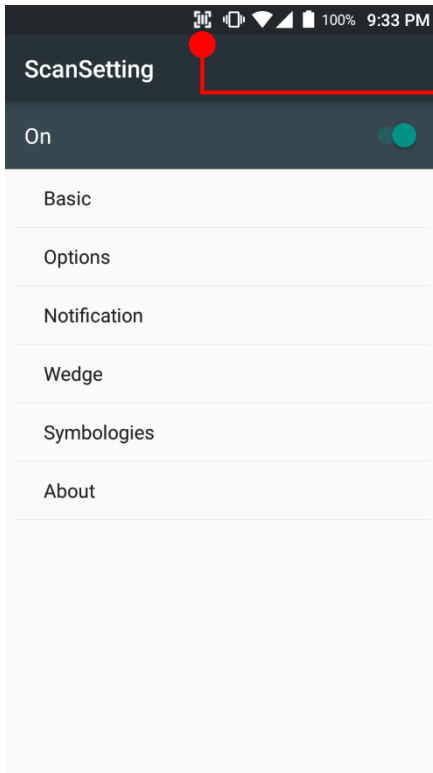

Now you can see “Scanner” icon in the “Status Bar”

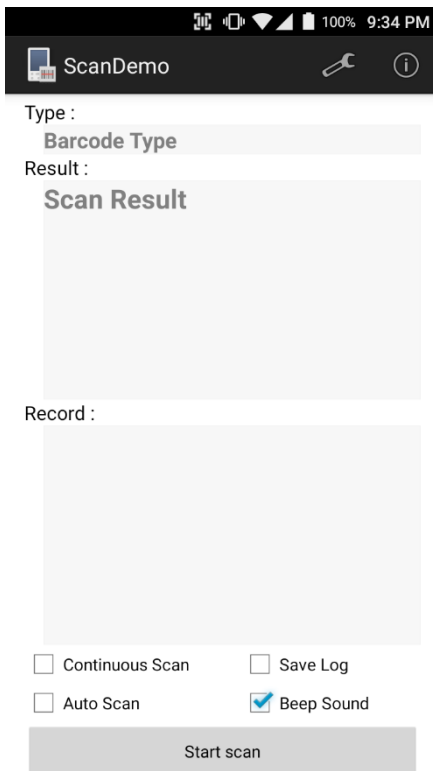

Note: When “Scanner” turned on, you can scan the barcode with “ScanDemo” in the EmKit

Use a Scanner

Scanner Settings

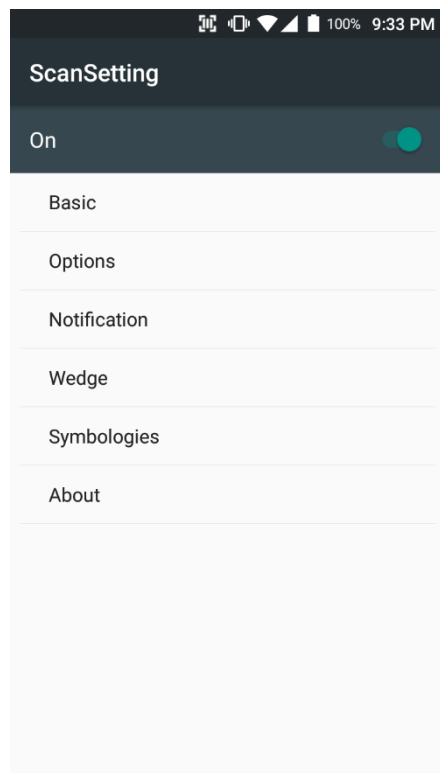

Scanner setting details

Scanner setting consist with “Basic”, “Options”, “Notification”, “Wedge”, “Symbologies”, and “About”

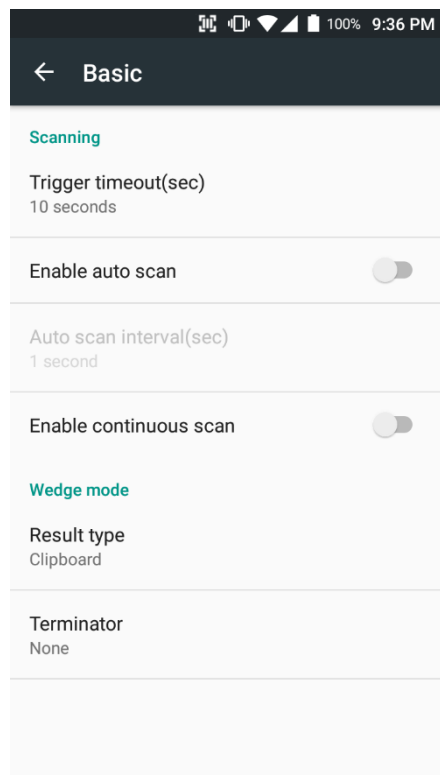

In the “Basic”, you can set “Scanning” option and “Wedge” mode option

In the “Scanning menu”, you can change Scanner’s trigger time out and set “Auto scan” & “Continues scan”

In the Wedge menu you can change, decode scan data’s result type handling “User Message”, “Keyboard Event”, “Clipboard’ or ‘Intent Broadcast’. Also you can set “Terminator” – “Space”, “Tab”, “LF” or “Tab & LF”

Use a Scanner

Scanner Settings

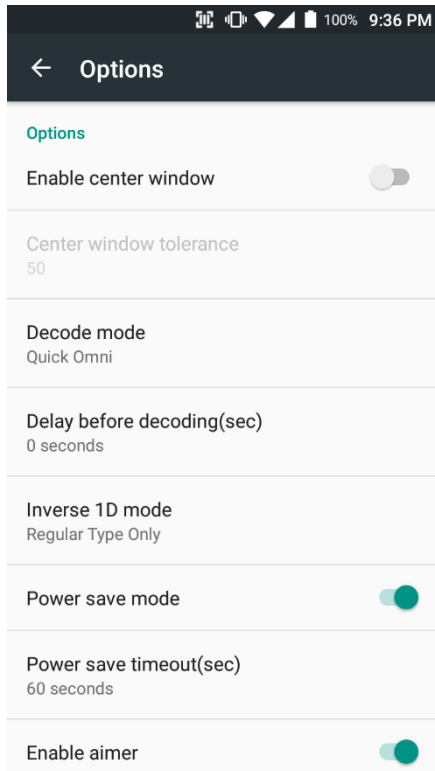

In the “Options”, you can enable / disable the “Center Window”, set “Decode mode”, “Power save mode” and enable / disable “Aimer” & “Illumination”

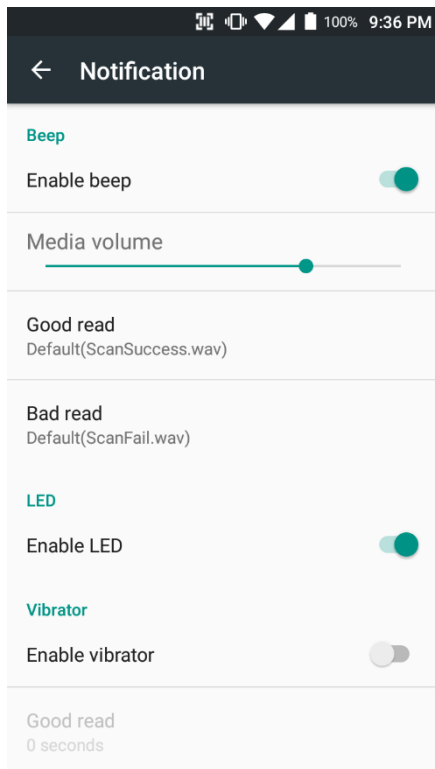

In the “Notification”, you can set notification option. You can change the volume level, notification sound, LED and vibration option

Use a Scanner

Scanner Settings

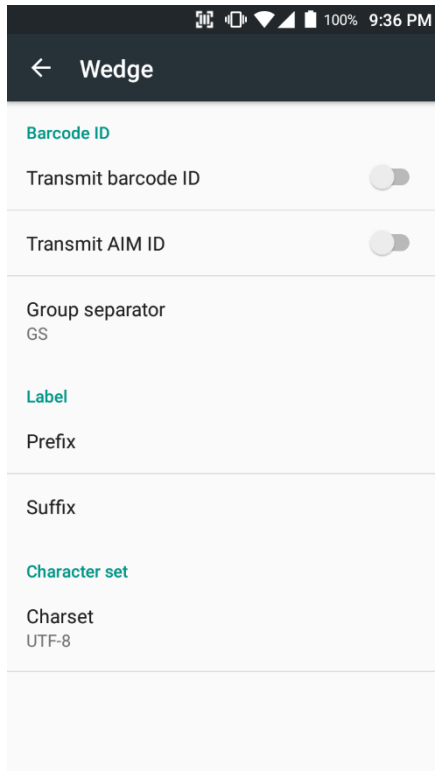

In the "Wedge", you can enable / disable "Barcode ID" and "AIM ID", set "Group separator", "Prefix" & "Suffix" and "Character set"

Use a Scanner

Scanner Settings

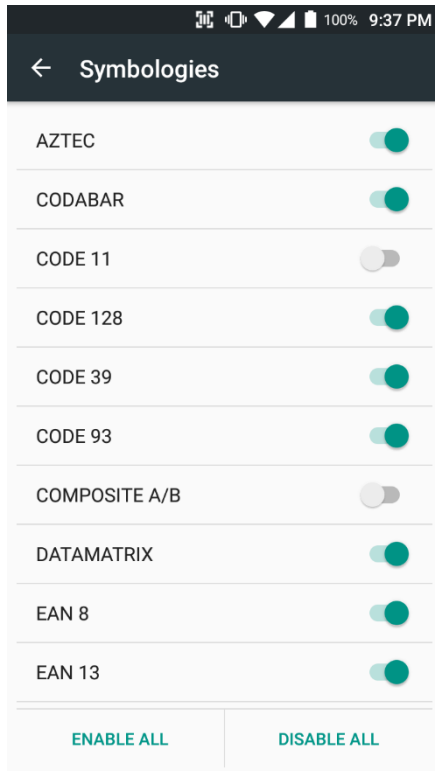

In the “Symbologies”, you can enable / disable specific barcode.

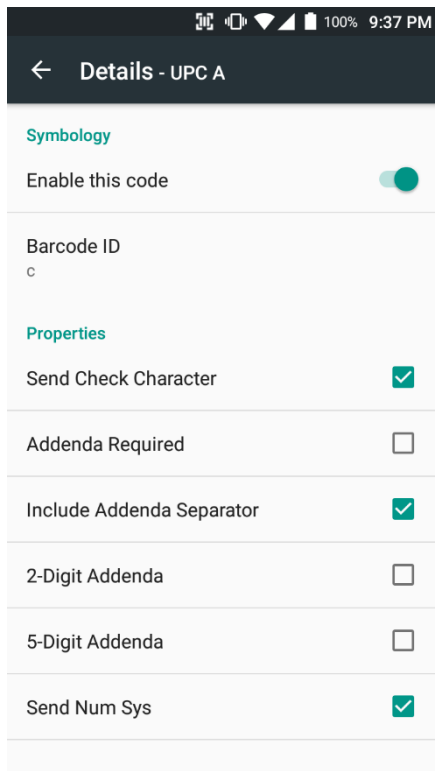

By touching each “Symbology” name, you can set detail option.

Use a Scanner

Scanner Settings

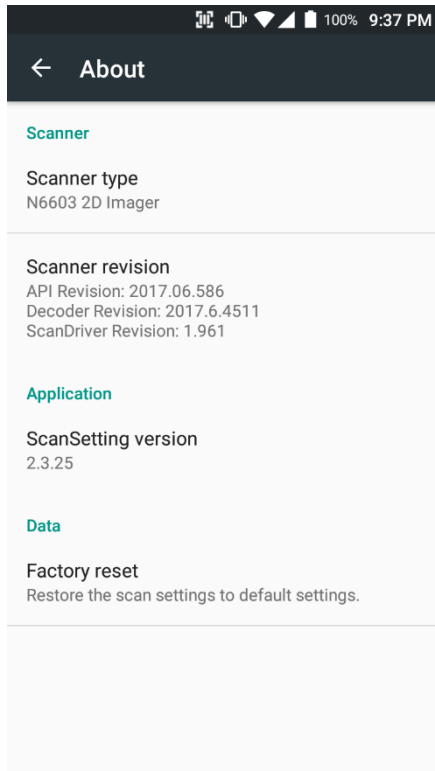

In the 'About', you can check your Scanner's information and restore Scanner's settings to default



Tip: By plug PM80 into the "Gun Handle", you can start to scan with "Trigger" button

Scan a Barcode

Scanner Settings

Example of good Barcode reading



Idle barcode scan
Please aim the middle of barcode



Even you aim the barcode slightly upper or down area or angle is slightly tilted, you can read the barcode



Scan a Barcode

Scanner Settings

Example of bad Barcode reading



If you aim the barcode wrong direction or tilt too much, you can't read the barcode

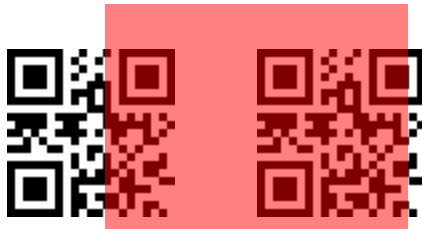

If you aim part of Barcode or aim two barcode together, you can't read the barcode

IC Card

Read a Credit Card

To read an “IC Credit Card” with PM80, please insert the card to the “IC Card Pocket”. IC chip should face the front side



IC Card



Magnetic Card

Read a Credit Card

To read a “Magnetic Credit Card” with PM80, please slide the credit card to the “Card slot” Magnetic bar should face the front side. You can read the card, bi-direction



Magnetic Card



Front side of the Card
Can read bi-direction



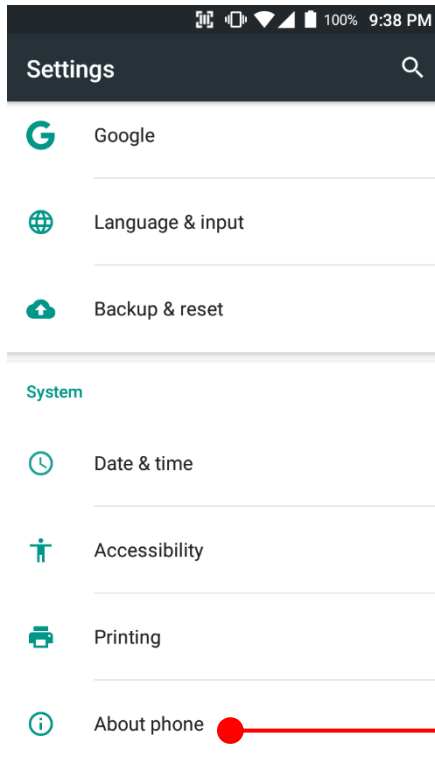

OS Image update from a Storage

OS Update



To update OS image, copy or place OS image file into the root folder of “Internal Storage” or “External Storage”

Touch  “App Drawer” -  “Settings” and then “About phone”

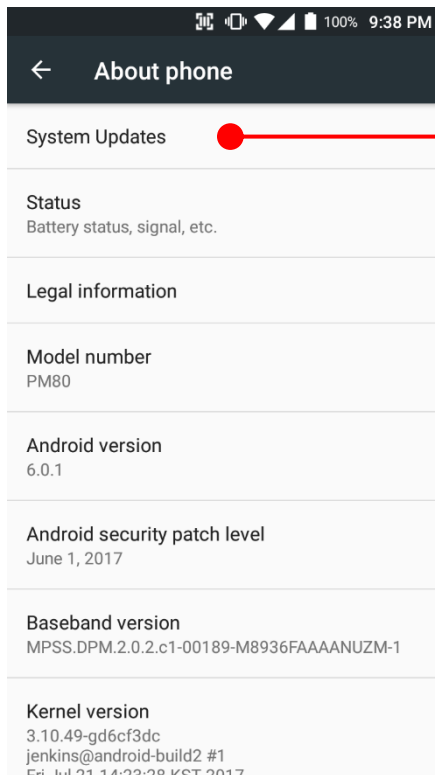

Touch “System Updates”

OS Image update from a Storage

OS Update

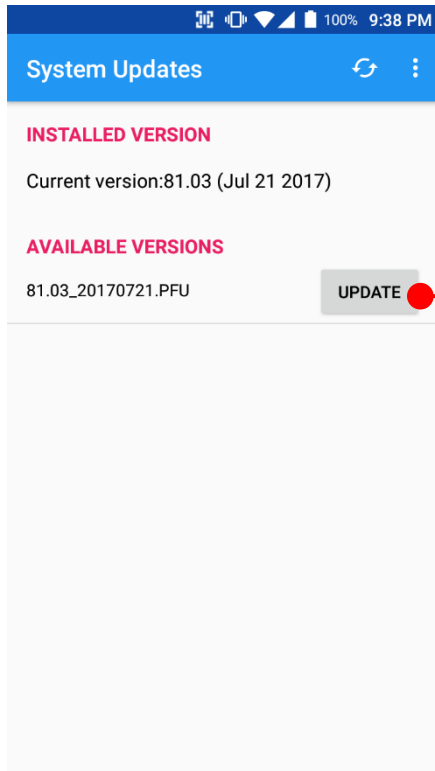

Your PM80 will check storage and display available OS image

Touch "Update" button

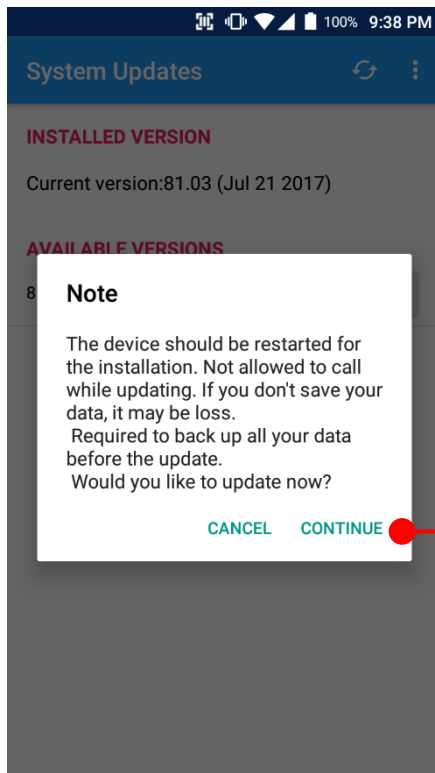

By touching the "CONTINUE" button, your PM80 start to update the OS image. During this time, you cannot use your PM80. Please save the data before start, the OS update process.

OS Image update from the FOTA

OS Update

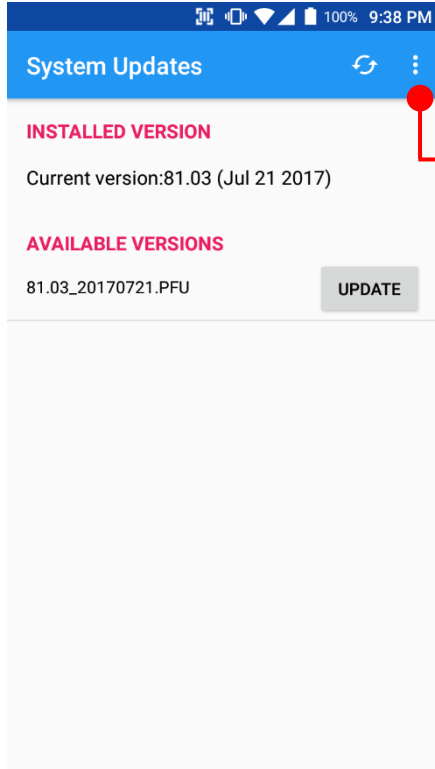

Tap  icon for the advanced option

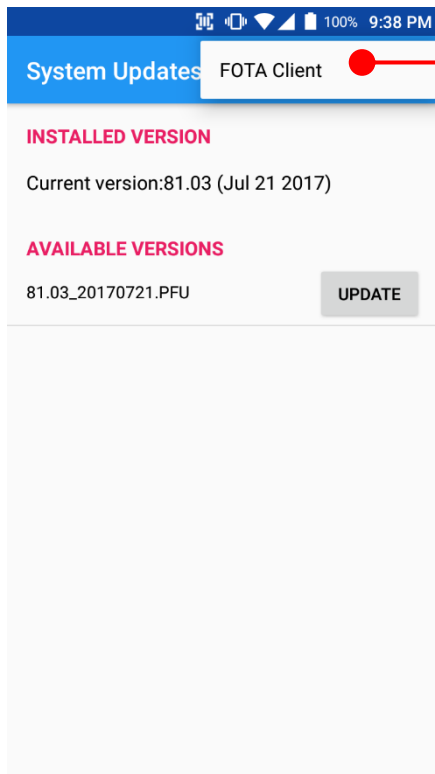

Touch "FOTA Client"

OS Image update from the FOTA

OS Update

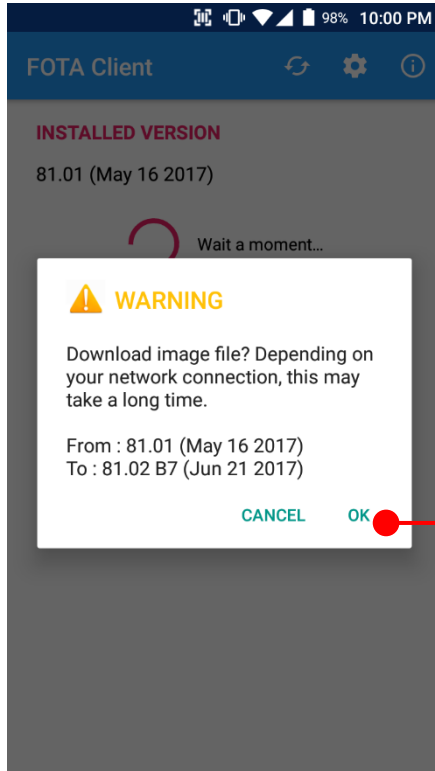

PM80 will compare the OS image between FOTA server and current OS image. If there is newer OS image in the FOTA server, FOTA server will suggest downloading.

Touch "OK" to start download the image in the FOTA server

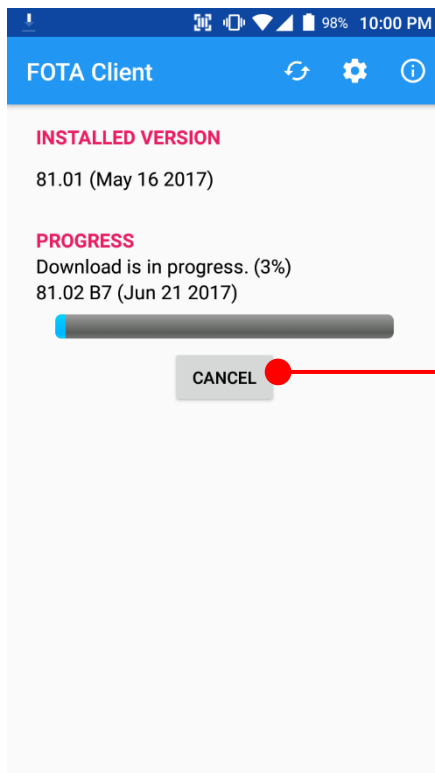

You can cancel OS image download process

Note: Default OS image download setting of FOTA Client is "Download over Wi-Fi only" Please connect to the nearby Wi-Fi network for FOTA service

Factory data reset from Settings

Factory data reset

When your PM80 system is unstable and abnormal behavior occur but could not recover by rebooting, you may need to “Factory data reset” your PM80

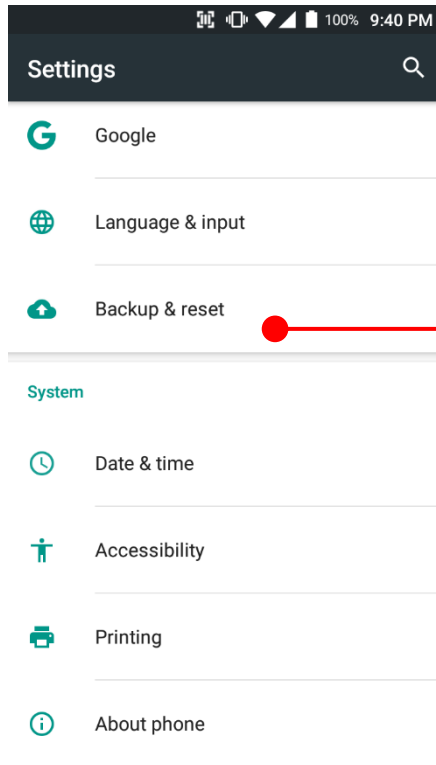

Touch  “App Drawer” -  “Settings” and then “Backup & reset”

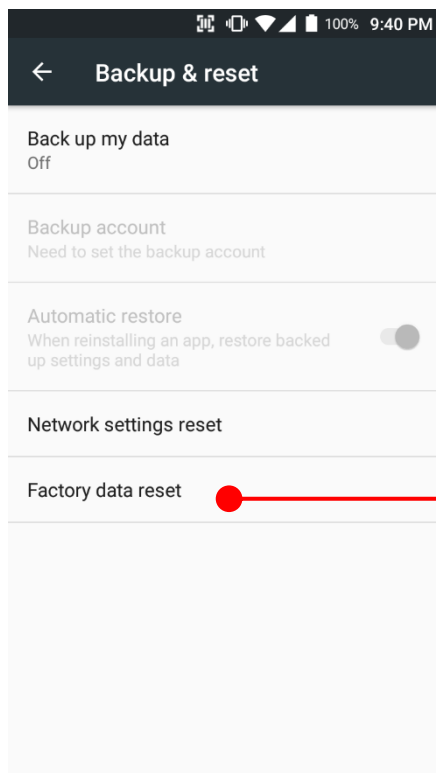

Touch “Factory data reset”

Factory data reset from Settings

Factory data reset

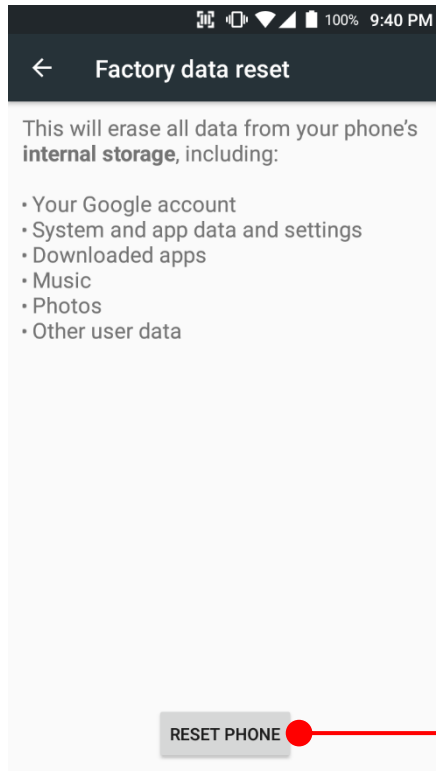

Please note, all apps and data in the internal storage will be deleted and restored to "Factory default" and this process cannot "Undo"

Touch to start "Factory Reset" process

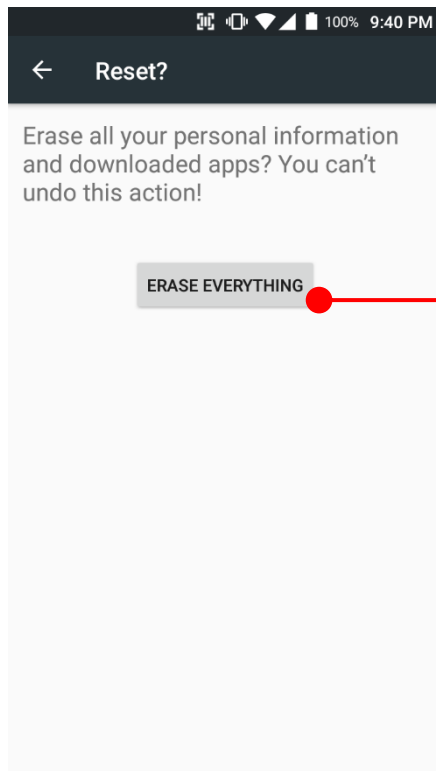

Touch to confirm erase of "Apps and Data"

Force Factory data reset

Factory data reset



Force Factory data reset your PM80

You can perform “force” factory data reset your PM80. When your PM80 turned off, press “Power” + “Volume up” + “Home” button all together. After short vibration from your PM80, you may release the buttons.



PM80 enter to the “Android Recovery” mode. In this mode, “Volume up” is “Move Up” in the menu tree and “Volume down” is “Move Down” in the menu tree. “Power Button” is “Select”

Force Factory data reset

Factory data reset



Select "Wipe data/factory reset"

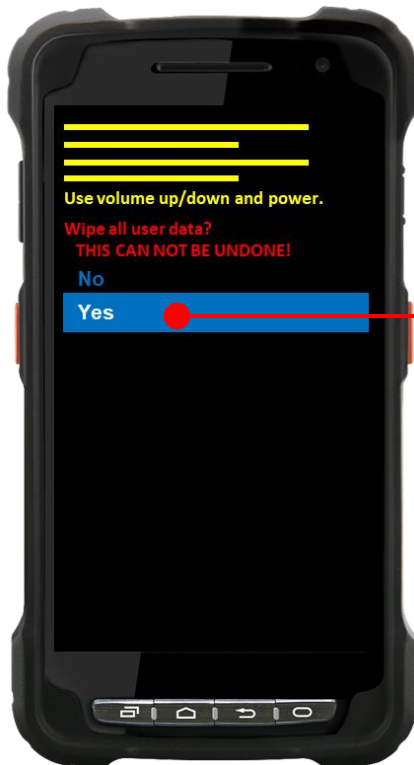

Select "Yes" to perform the "Factory data reset"
After that, your PM80 start wiping the data

Force Factory data reset

Factory data reset

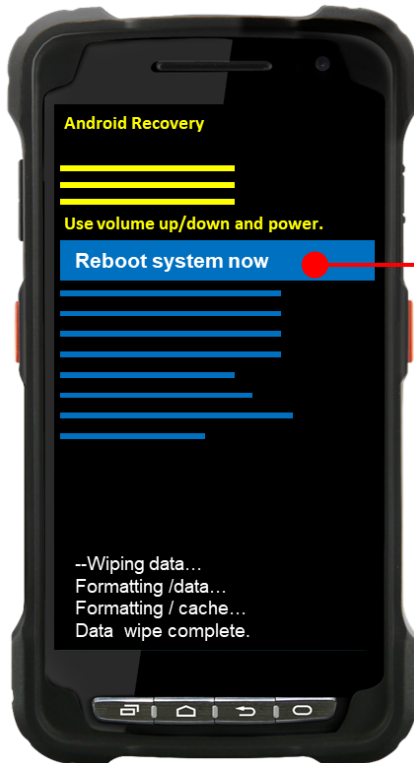

After data wiping, please select “Reboot system now” to finish the “Force Factory data reset” process

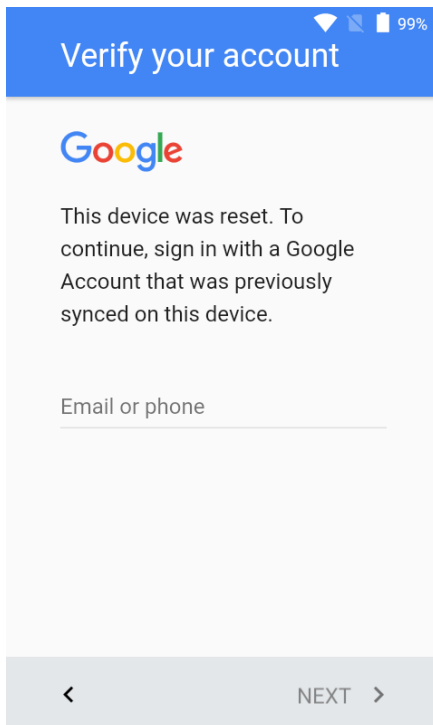

After Force factory reset, if PM Android Device locked by Factory Reset Protection, then please enter to Fast Boot mode and execute command

- fastboot erase config
- fastboot reboot

Note: Factory Reset Protection (FRP) is a security method that was designed to make sure someone can't just wipe and factory reset your device if you've lost it or it was stolen

Enterprise Mobility Kit

EmKit

Enterprise Mobility Kit – Truly, what Enterprise needs

Point Mobile announces new software solution – called “EmKit” is new software solution for enterprise mobility users. Our every Android device shall have EmKit pre-installed and every user can access them for free of charge*. EmKit offers truly-value-added advantages, for enterprise users, which are against consumer-centric & non-customizable smartphones. Every solution in EmKit is 100% compatible with Point Mobile Android GMS certified devices.

* Necessary MDM license subjects upon individual subscribers

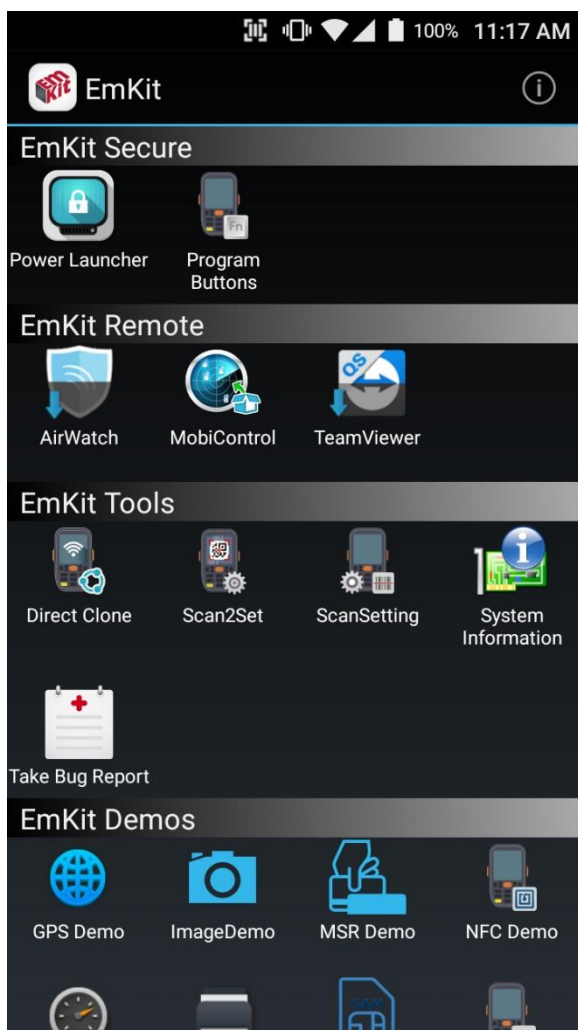

EmKit consist with “**EmKit Secure**”, “**EmKit Remote**”, “**Emkit Tools**” and “**EmKit Demos**”

- EmKit Secure “Lock Your Device”
- EmKit Remote “Mobile Device Management”
- EmKit Tools “Smarty Tools Ease Enterprise”
- EmKit Demos “Friendly For Programmers”

EmKit Secure

EmKit

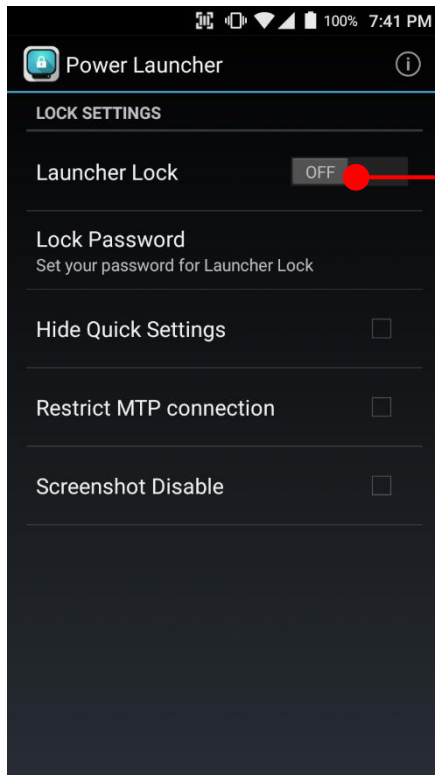

Power Launcher

You can lock your Point Mobile Android model's **Home Screen** and limit to access app drawer or specific function. This function as known as **Kiosk mode**.

- Hide Quick Settings : Limit to access quick setting panel
- Restrict MTP connection : Limit to access Point Mobile Device's MTP connection
- Screenshot Disable : Disable screenshot capture in OS level

Restriction feature will be keep added.

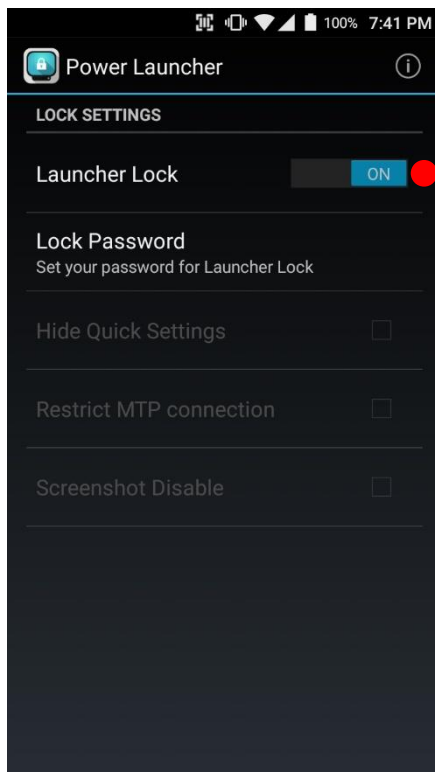

After restriction feature check, switch **Launcher Lock** to On.

EmKit Secure

EmKit

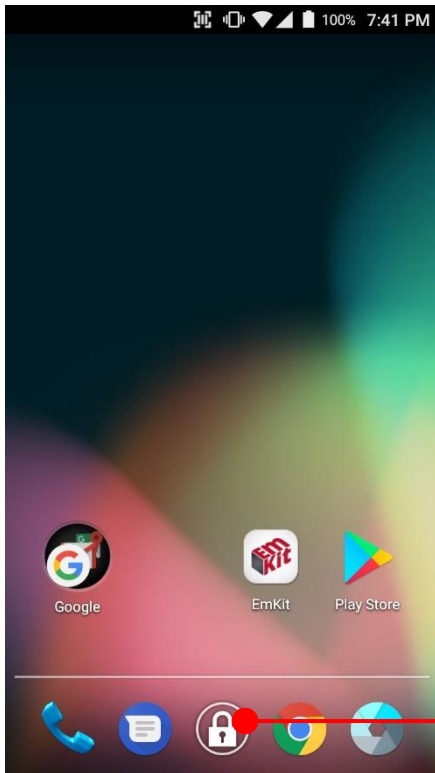

When Power Launcher is locked, operator could not access to **App drawer**.

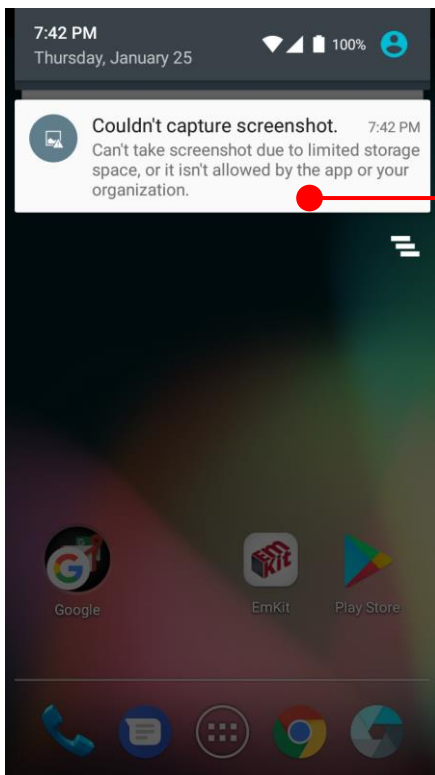

Example of **Screenshot Disable** restriction.

EmKit Secure

EmKit

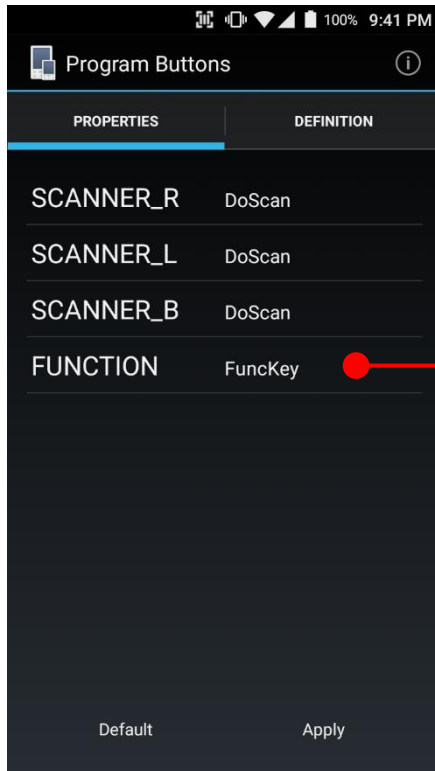

Program Buttons

You can assign Hardware buttons function to rich pre-assigned functions.

Also you can applying the customized KCM file (Key Character Map Files) here.

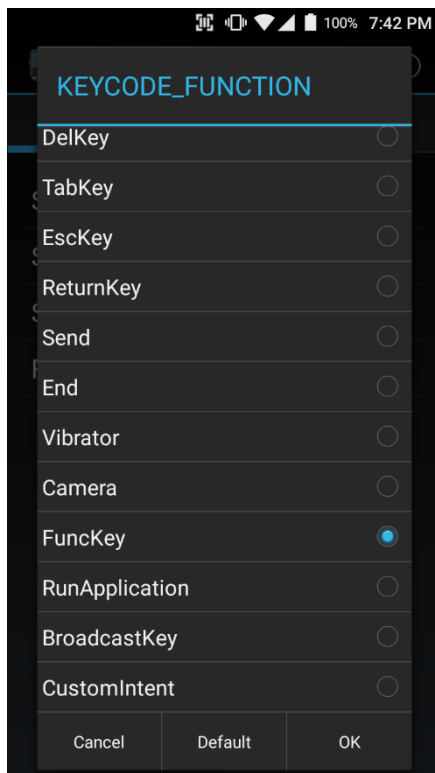

EmKit Remote

EmKit

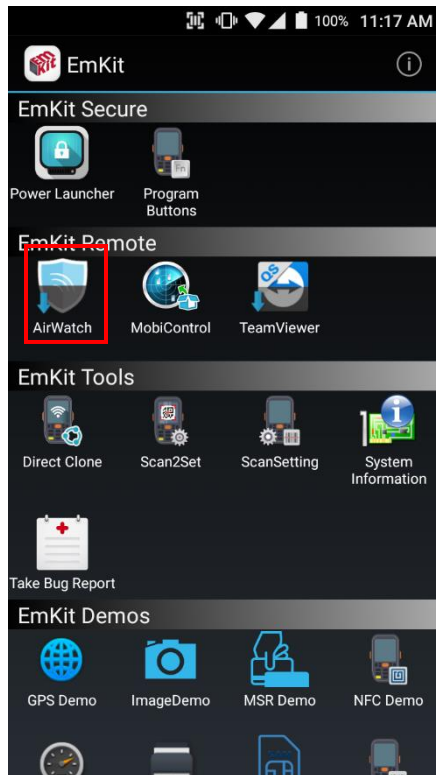

To install the AirWatch agent to Point Mobile Android device, please touch AirWatch icon

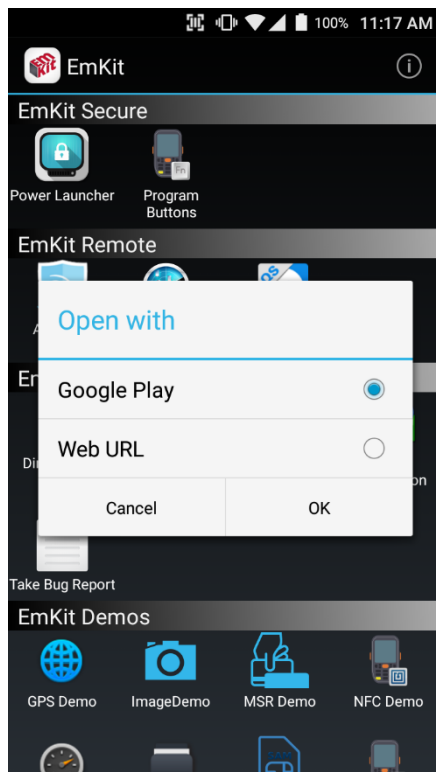

App provides AirWatch agent install via Google Play or Web URL.

- Google Play method requires Google account login. AirWatch agent download and install managed by Google Play
- Web URL method requires user's manual installation

EmKit Remote

EmKit

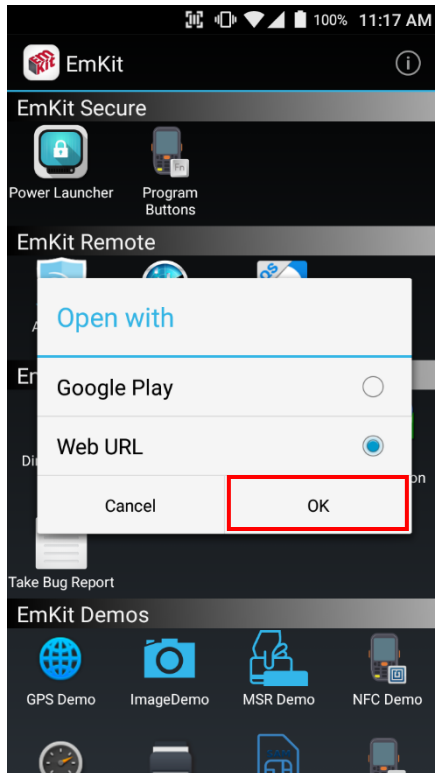

To install AirWatch agent from Web URL method, select Web URL and then **OK**

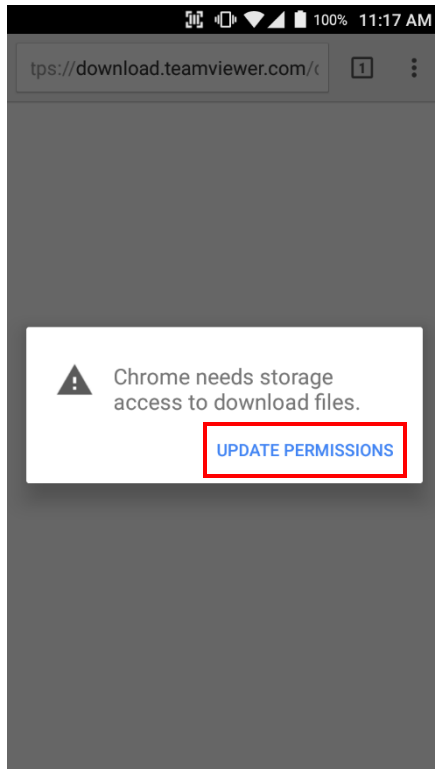

Web browser will download the apk file to the Point Mobile Android device. Before downloading, browser need permission to download apk file to the storage. Please touch **Update Permissions** button

EmKit Remote

EmKit

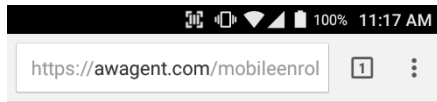

After permission update, web browser download the latest version of AirWatch agent apk file. Install this apk file to Point Mobile Android device.

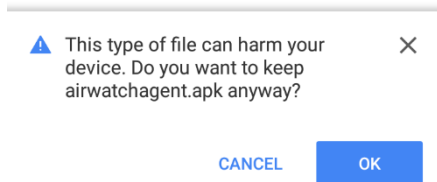

Note: If you need to install specific agent version, please contact to AirWatch

EmKit Remote

EmKit

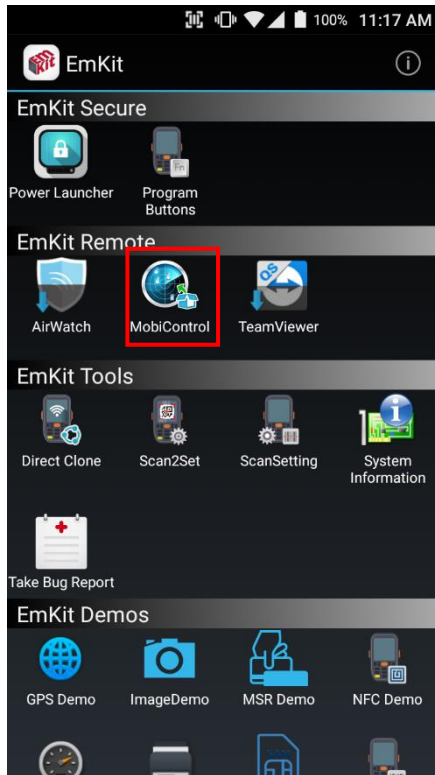

SOTI Mobi Control installer is pre-installed to Point Mobile Android device. To start enrollment process, please touch MobiControl icon

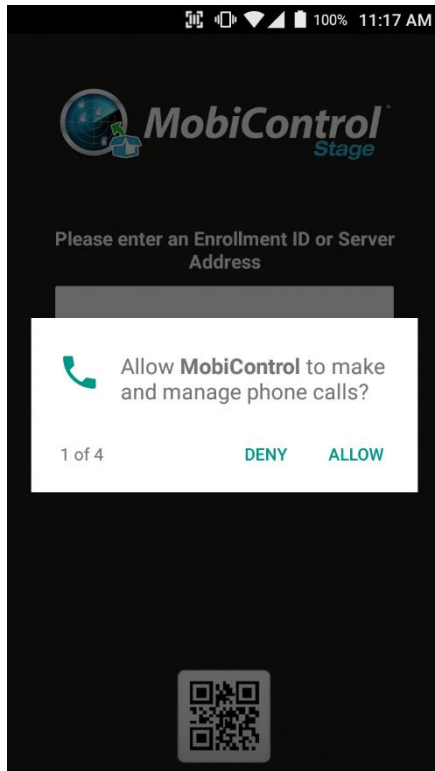

Mobi Control app request permission grant during enrollment process. Please allow it.

EmKit Remote

EmKit

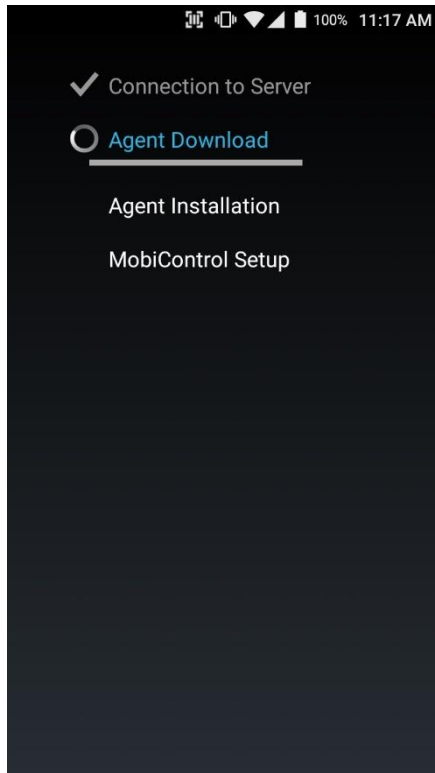

After login, Mobi Control app communicate with SOTI server and then install the Mobi Control agent

Note: Agent version determine from SOTI console's setting. If agent version is incorrect after enrollment, please contact to SOTI

EmKit Remote

EmKit

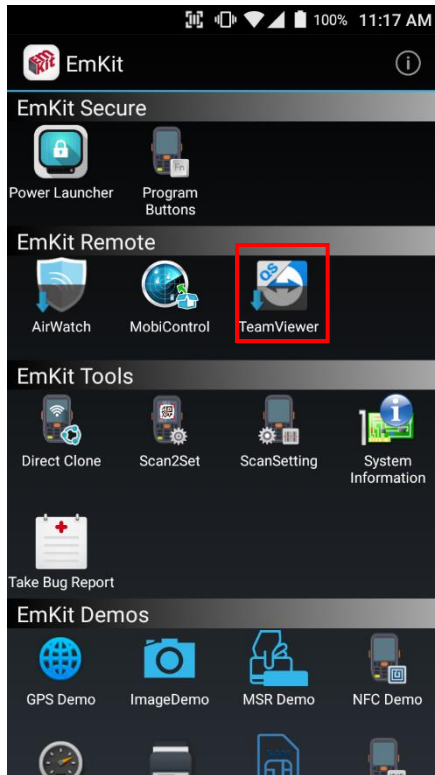

To install the TeamViewer QS app to Point Mobile Android device, please touch TeamViewer icon

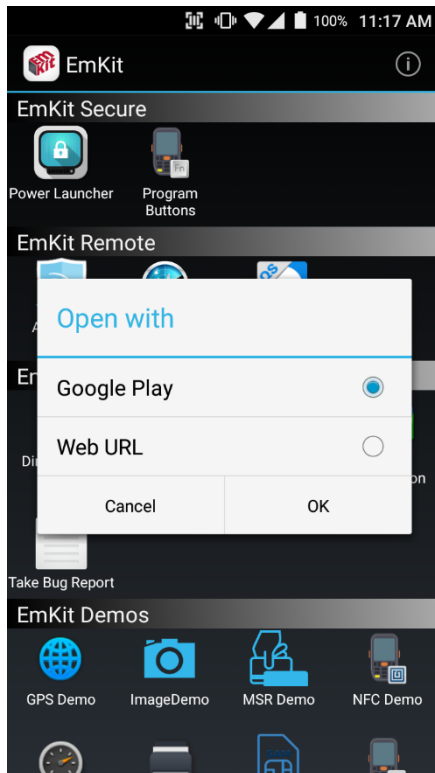

App provides TeamViewer QS app install via Google Play or Web URL.

- Google Play method requires Google account login. TeamViewer QS app download and install managed by Google Play
- Web URL method requires user's manual installation

EmKit Remote

EmKit

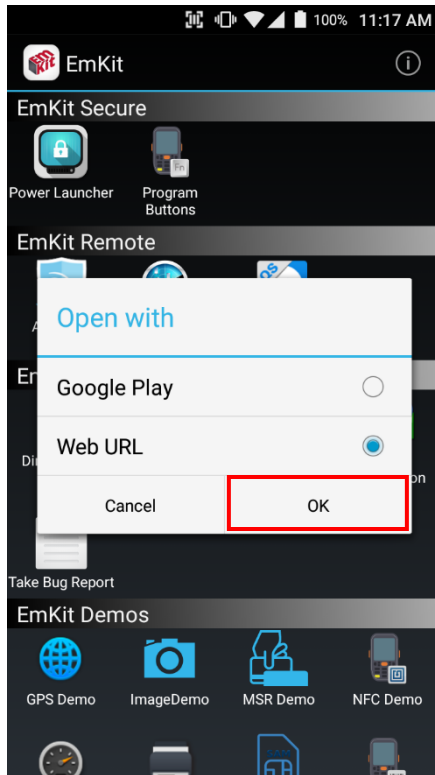

To install TeamViewer QS app from Web URL method, select Web URL and then **OK**

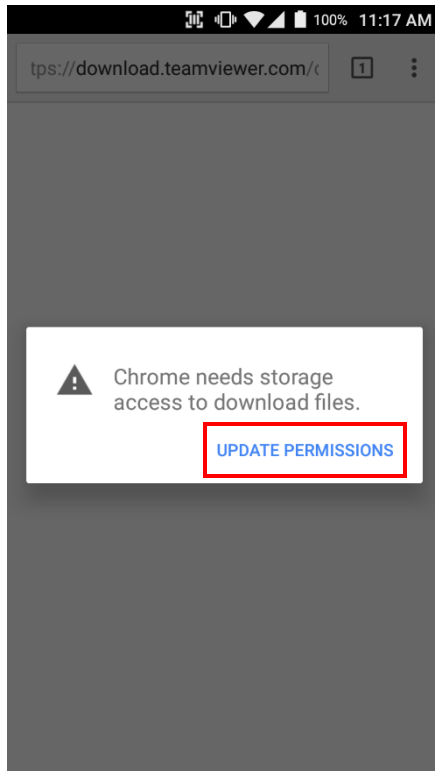

Web browser will download the apk file to the Point Mobile Android device. Before downloading, browser need permission to download apk file to the storage. Please touch **Update Permissions** button

EmKit Remote

EmKit

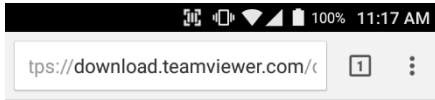

After permission update, web browser download the latest version of TeamViewer QS apk file. Install this apk file to Point Mobile Android device.

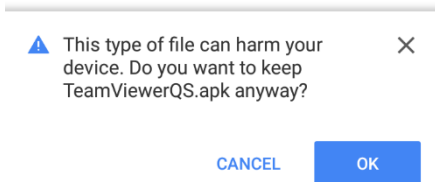

Note: If you need to install specific TeamViewer QS version, please contact to TeamViewer

EmKit Tools

EmKit

Direct Clone

Create the **Master PDA** - backup your system settings and apps into a secured file. Without any network connection, Master PDA become a local server in your work place. Nearby Point Mobile device will automatically communicate with Master PDA and download the backup file and then **Restore**.

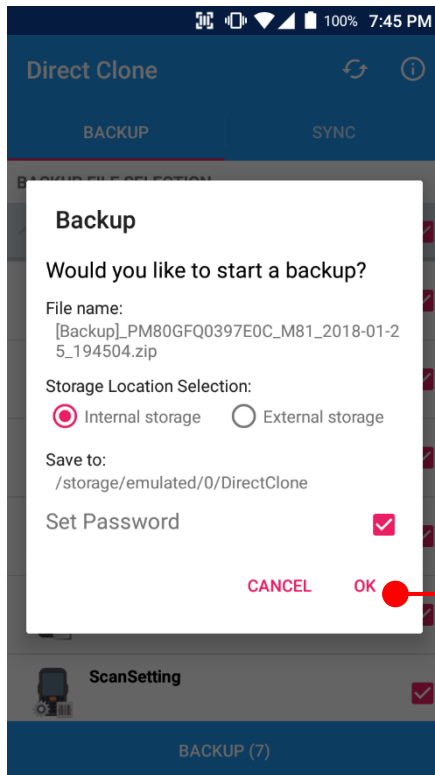

Create the backup file

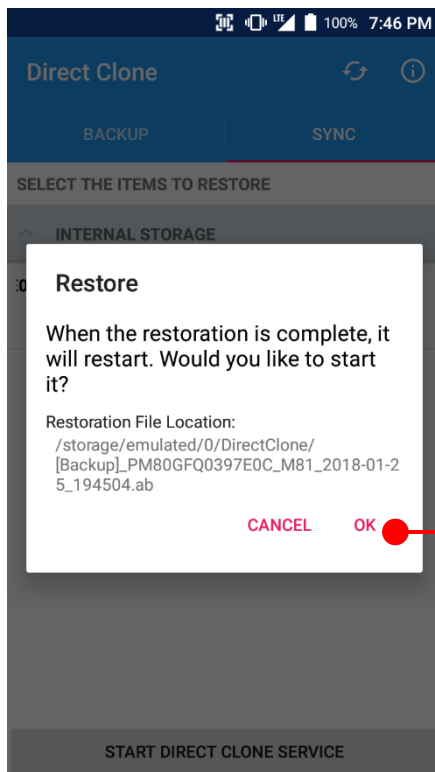

Backed up file will restore your Point Mobile Android device.

EmKit Tools

EmKit

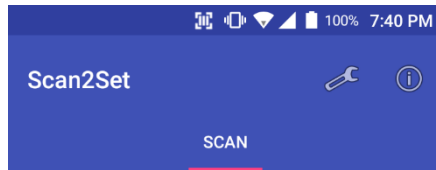

Scan2Set

Scan2Set is designed for the network environment. Point Mobile Android device downloads the Direct Clone file from the FTP, Web server and Google Drive with just one QRcode Scan!



Scan your QR code and,

- Connect to your network
- Restore your PDA
- Work Managed Device setup

SCAN START

Step 1. Create Direct Clone Backup file

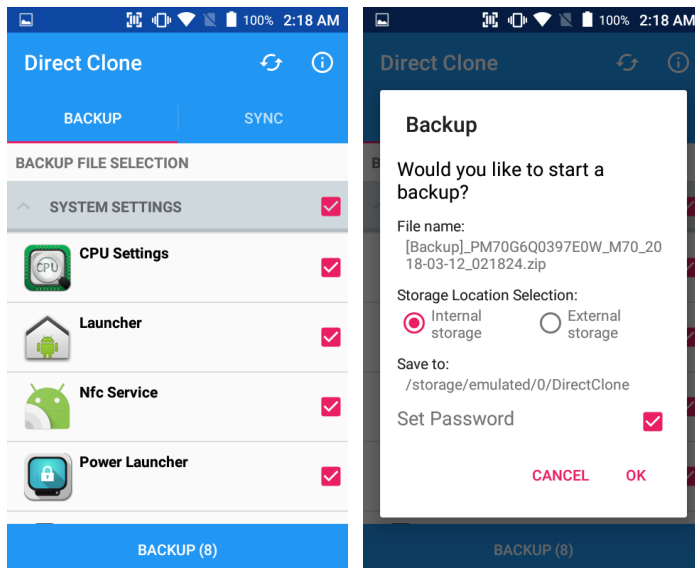

- Make a Direct Clone file from Master PDA device

EmKit Tools

EmKit

Step 2. Upload Direct Clone file to your FTP site or Web server

- Copy the Direct Clone file from the Point Mobile Android device

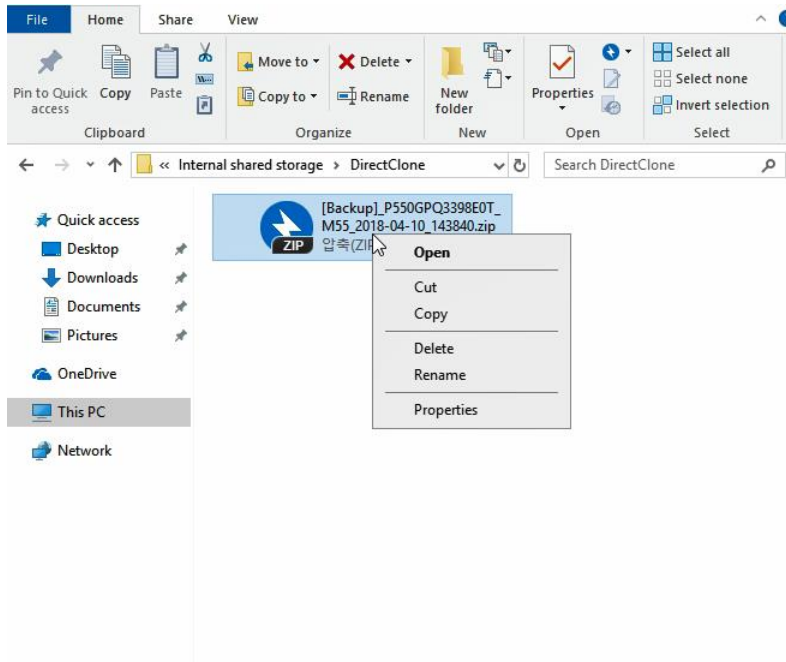

- Upload this file to your FTP site or Web Server. You may change file name

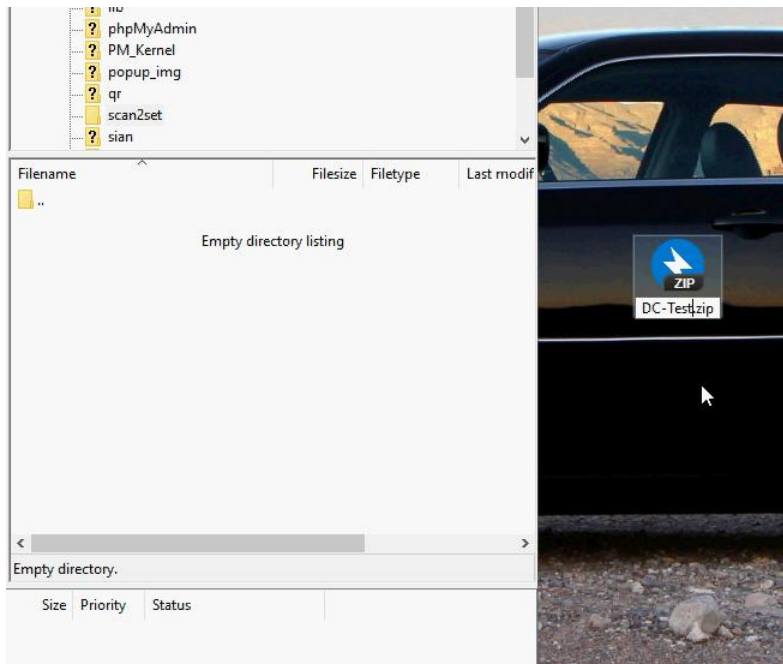

EmKit Tools

EmKit

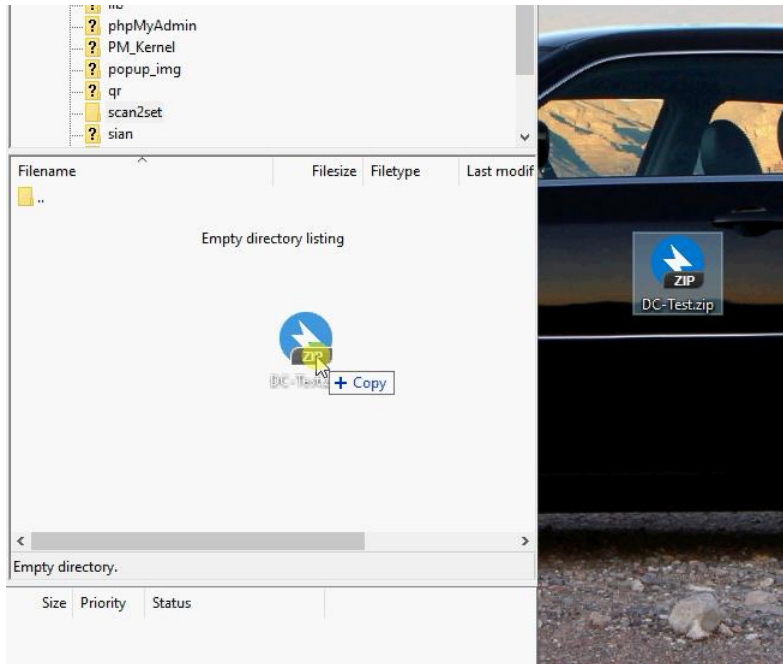

- After file uploading, please check the url first. File should be download with url address.

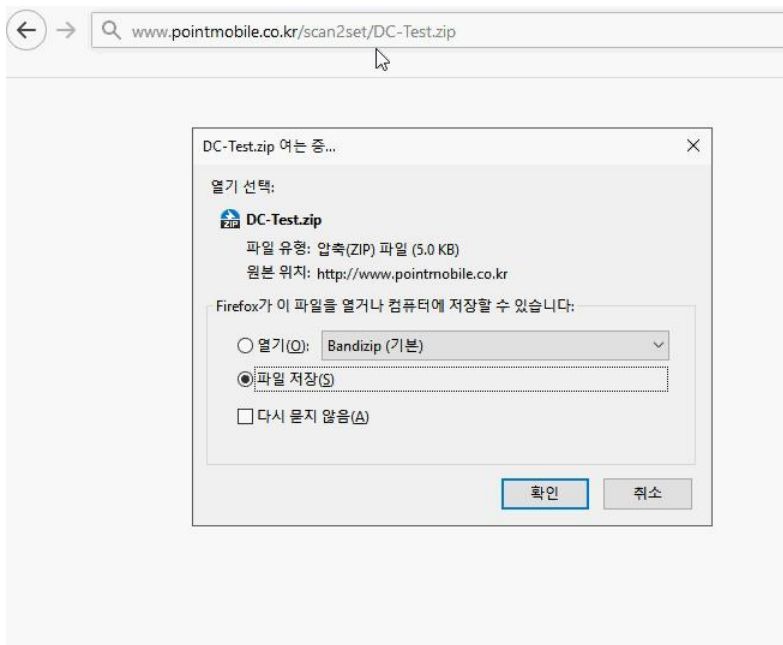

EmKit Tools

EmKit

Step 3. Generate QRcode

- Access to Web QRcode generating site www.pointmobile.co.kr/qr

- Click **Web/Google Drive** menu
- Input Network information, Direct Clone file name and password

EmKit Tools

EmKit

Web/Google Drive
FTP
Work Managed Device Enrollment
json format

Network Setup

SSID:
 Hidden

Password:

Security Type: None WEP WPA,WPA2,WPA2PSK

Direct Clone File Location

URL:

File Name:

Password:

Note: Make sure put http:// or https:// in front of url address

- Click **Generate QRcode** button and save or print generated QRcode

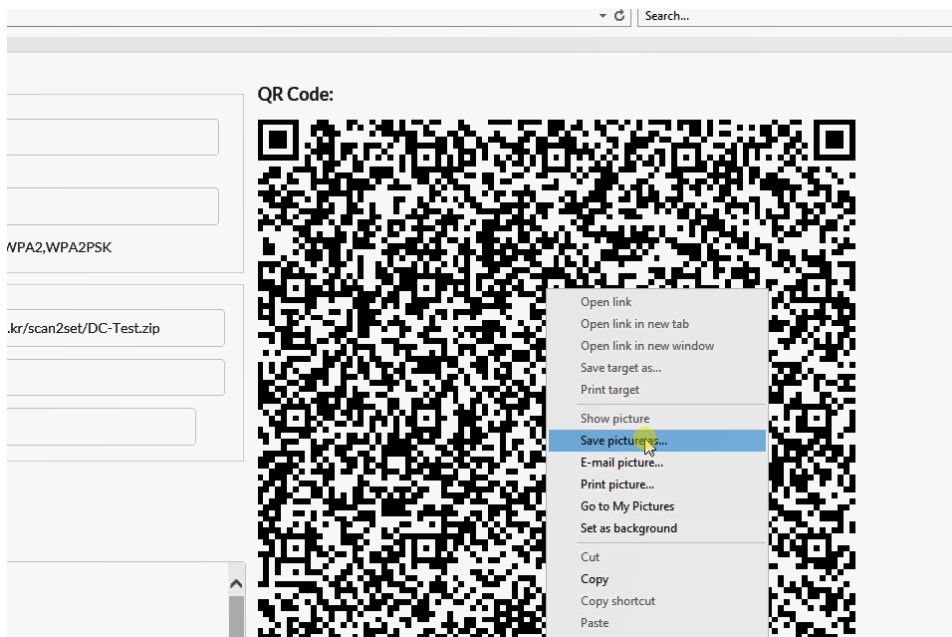

EmKit Tools

EmKit

Step 4. Read QRcode in other PDAs

- Turn on your Point Mobile Android device.
- Press the Power Button, then you will see the Scan2Set in the menu

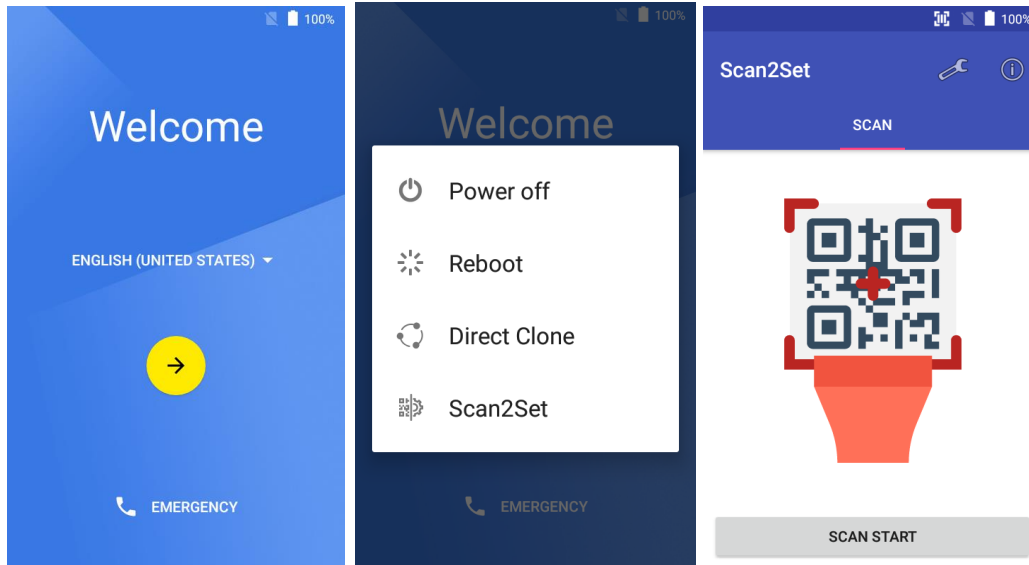

- Read the generated QRcode. Point Mobile Android device will download the file from the FTP site or Web server and restore Direct Clone file

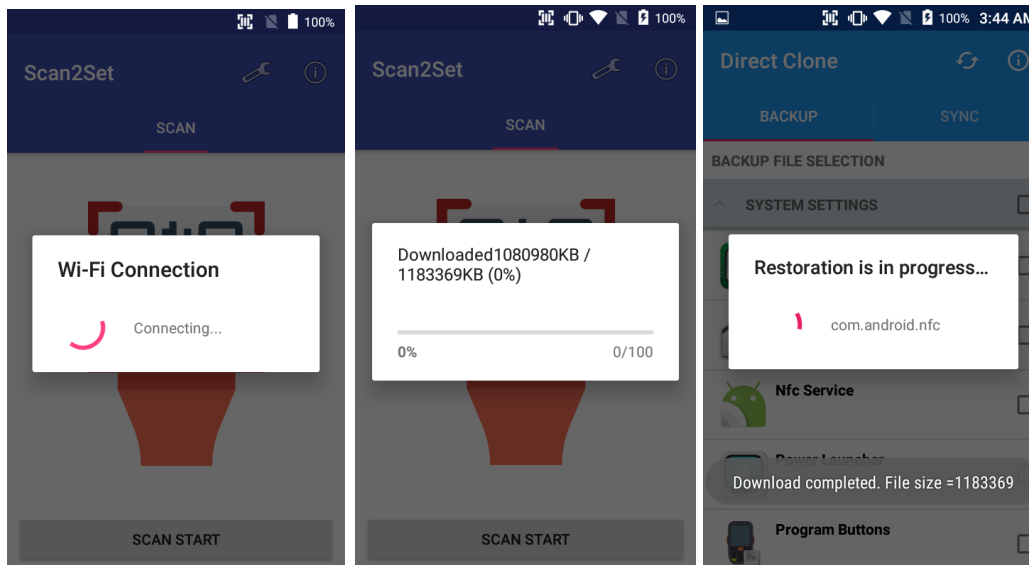

EmKit Tools

EmKit

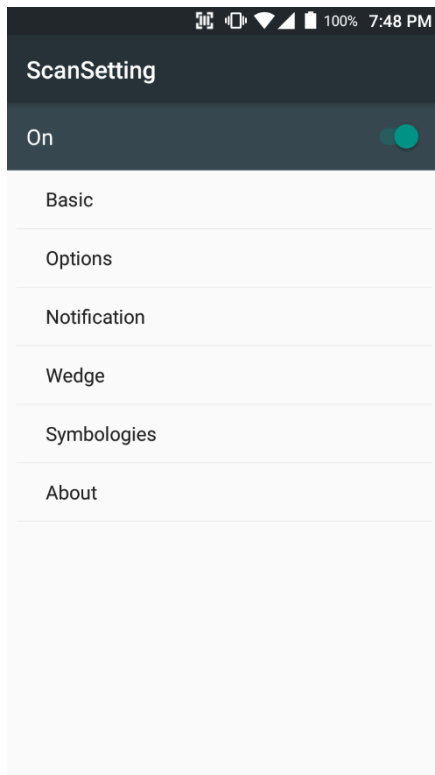

ScanSetting

You can set your PM80's scanner option with intuitive menu.



System information

All of SW and HW information available here and can save it to the file.

- Touch **Save to file**.
- **devinfo.html** file saved to root folder of the internal storage.

EmKit Tools

EmKit

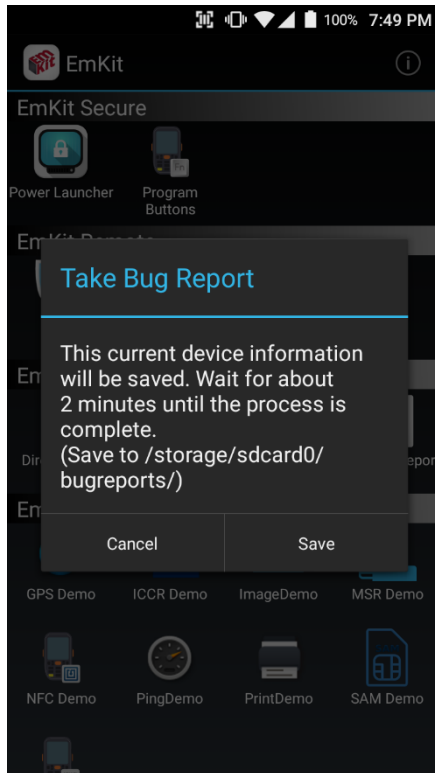

Take Bug Report

This function save logs and event to the internal storage. When you have a field issue, and need to contact service center, please find the reproduce step first.

- Reproduce the issue.
- After issue, reproduce, please run **Take bug report**.
- File will be saved to **bugreports** folder.
- Copy the file to the PC and then zip it to reduce the file size.
- Share bug report file to the service center or Point Mobile Support team with reproduce steps.

EmKit Demos

EmKit

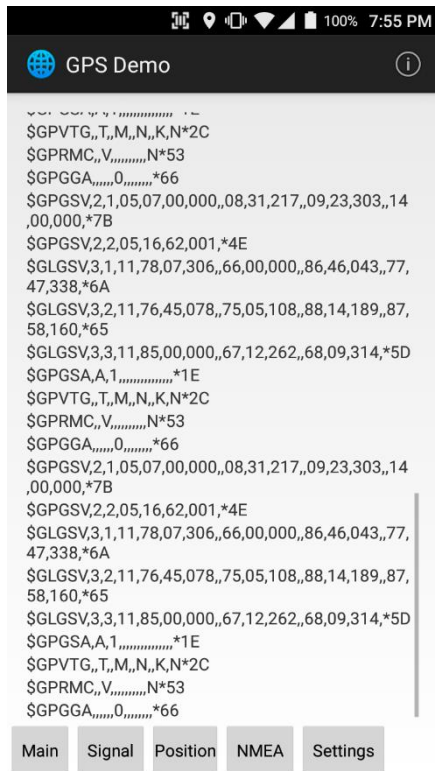

GPS Demo

Developer can demonstrate or check Point Mobile Android model's GPS signal strength, Satellite info, NMEA info.

Some of demo app only available for specific Hardware feature integrated SKU (Stock Keeping Unit)

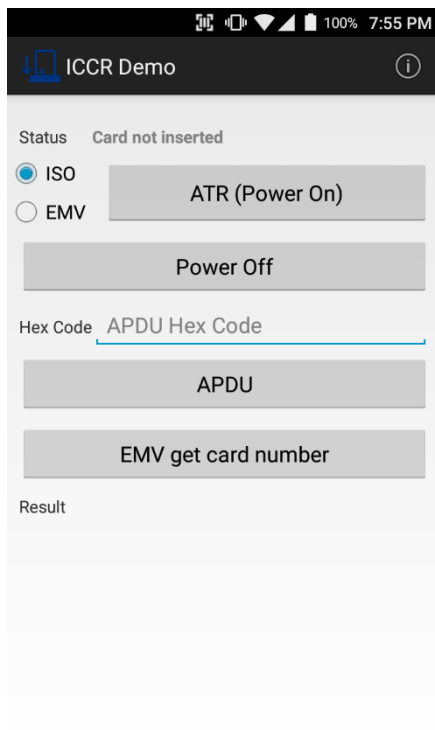

ICCR Demo

Developer can demonstrate or check Point Mobile Android model's payment solution.

Some of demo app only available for specific Hardware feature integrated SKU (Stock Keeping Unit)

EmKit Demos

EmKit

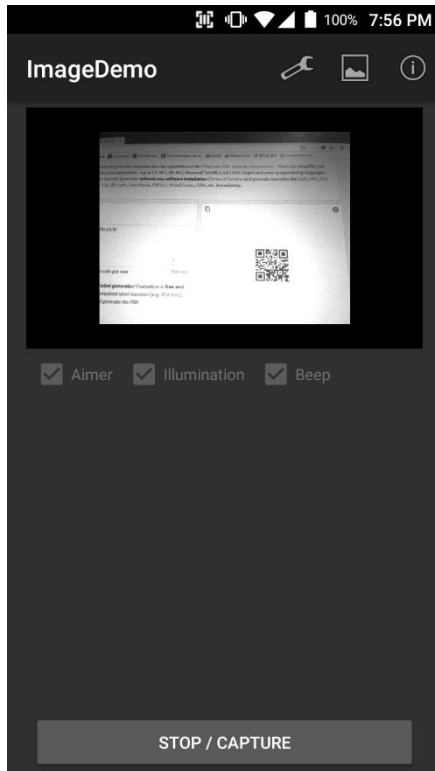
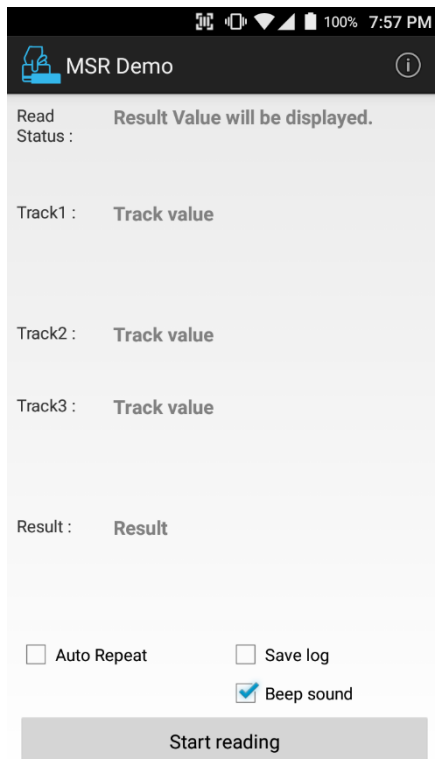

Image Demo

Developer can demonstrate or check Point Mobile Android model's 2D scanner's image taking solution.

Some of demo app only available for specific Hardware feature integrated SKU (Stock Keeping Unit)



MSR Demo

Developer can demonstrate or check Point Mobile Android model's IC card and Magnetic card reading solution.

Some of demo app only available for specific Hardware feature integrated SKU (Stock Keeping Unit)

EmKit Demos

EmKit

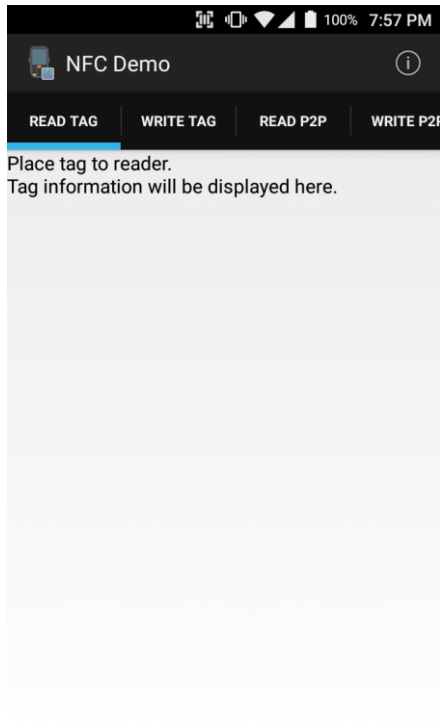

NFC Demo

Developer can demonstrate or check Point Mobile Android model's NFC Read/Write solution.

Some of demo app only available for specific Hardware feature integrated SKU (Stock Keeping Unit)

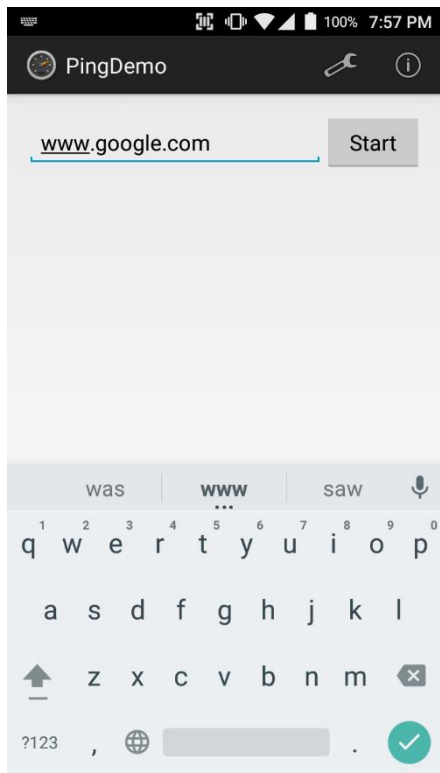

Ping Demo

Developer can demonstrate or check Point Mobile Android model's ping test.

EmKit Demos

EmKit

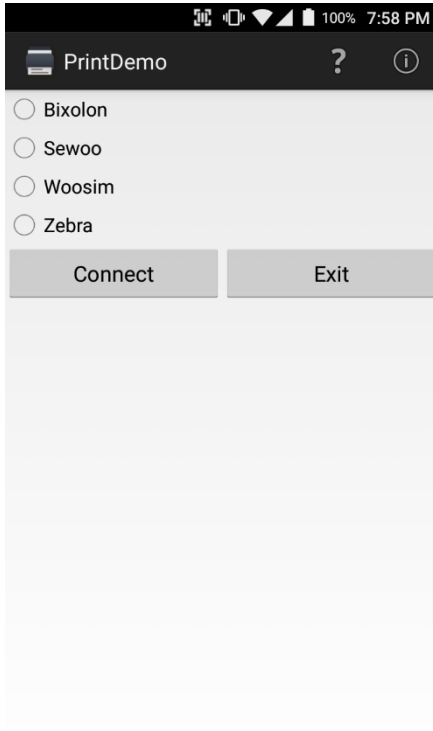

Print Demo

Developer can demonstrate or check Point Mobile Android model's Bluetooth mobile printing solution.

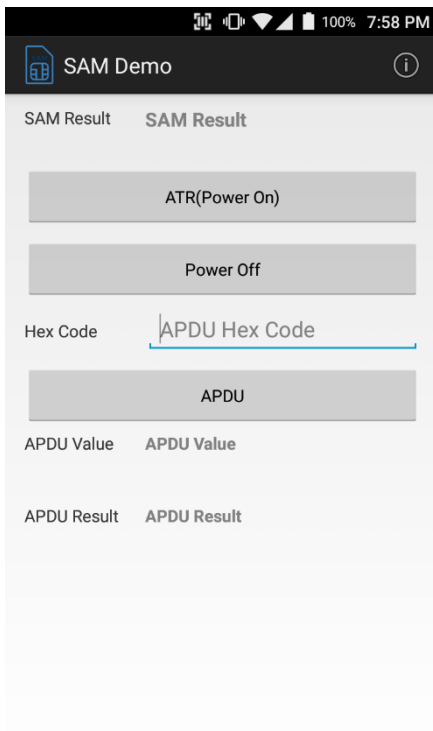

SAM Demo

Developer can demonstrate or check Point Mobile Android model's SAM communication.

Some of demo app only available for specific Hardware feature integrated SKU (Stock Keeping Unit)

EmKit Demos

EmKit

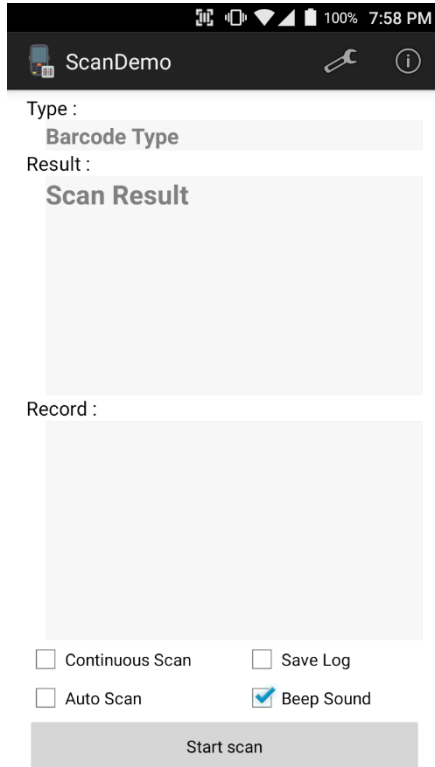

Scan Demo

Developer can demonstrate or check Point Mobile Android model's Scanner solution.

Some of demo app only available for specific Hardware feature integrated SKU (Stock Keeping Unit)



POINT MOBILE. CO., LTD.

Offline

Tel: +82-2-3397-7870~1

ARS: 1800-3010

Fax: +82-2-3397-7872

Address: B-9F Kabul Great Valley, 32, Digital-ro 9-gil,
Geumcheon-gu, Seoul, Korea 08512

Online

Website: <http://www.pointmobile.co.kr/>

E-mail: pm_support@pointmobile.co.kr